

RAPCO

RAPCO EQUIPMENT INC.

RAPCO

5510 Vanden Abeele
St-Laurent, Que. H4S 1P9
Telephone : 514-332-6562
Fax : 514-332-6761

1325 Leeds ave.
Ottawa, Ont. K1B 5K9
Telephone : 613-748-9762
Fax : 613-748-7067



**INDUSTRIAL AND CONSTRUCTION SUPPLIES
HAND AND POWER TOOLS
INDUSTRIAL HOSE AND FITTINGS
SAFETY CLOTHING AND EQUIPMENT
WIRE CABLES AND ACCESSORIES**

**WE SPECIALIZE IN SERVICE
FREE DELIVERY**

514-332-6562

613-748-9762

RAPCO



RAPCO



Karnaschi
PROFESSIONAL TOOLS



BAND-IT®



Lufkin



BUCHANAN RUBBER LTD

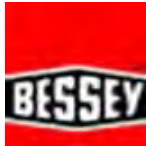

A World Leader in Hose Fittings and Accessories



The Right Connection™



Campbell®

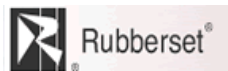
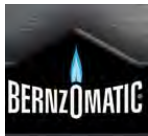

CROWN-MEAKINS

Since 1852 / Depuis 1852



KLEIN



MARSHALLTOWN The Premier Line



FILL-RITE

VANGUARD

ergo®

METALTECH



Weller®

FEATHERLITE

H.K.Porter®



A)		B)	
Abrasives	213-223	Blades, diamond	214,215
Absorbant	165	Blades, hacksaw	275
Acid suits	39	Blades, jig saw, recipro saw	227
Adaptors, fire hose, hydrant	91	Blanket, emergency	77
Adhesives, anaerobic	157	Block, rope	118
Air couplers and fittings	93,95	Blocks, wire	118
Air drills	234	Blow guns	172
Air hammers and accessories	35,236	Blowers	61
Air horns	70	Boat winches	178
Air hoses	85,86	Bolt bags	267
Air line filters	236	Bolt cutters	263
Air line lubricators	236	Bolts and nuts	255
Air line pump kits	24	Booster cables	207
Air regulators	172,236	Booster pacs	205
Air tools	233,234,235,237	Boots, leather	52,53
Air tools accessories	236	Boots, rubber	48,49,51
Air valves	93	Boss fittings and clamps	93
Aircraft cables	109,110	Boss valves	93
Ajustable wrenches	312	Boxes, tools	295,296,297
Akro-bins containers	79	Brass shimstock	96
Aprons	41	Brick cart	367
Armbands	46	Brooms	164
Arrow staplers	243	Brushes, floor	164
Asphalt rakes	341	Brushes, paint	143,144,146,147
Auger bits	230	Brushes, parts cleaning	144
Axes	286,349-352	Brushes, radiator	144
B)		Brushes, wire	224,225
Back support belt	77	Bucket/combo	165
Bags, garbage	165	Buckets, canvas	266
Bags, jute, plastic	74	Bulbs	207
Bags, tools	267	Bull floats	261
Ball valves	93	Bull pins	268
Band-it, clamps and tools	98-102	Bump, speed	72
Barricade lights	70	Burners	250
Barricade tape	62	Burs, rotary	225
Barricades	70	C)	
Bars, crow, pry	260,284,359,360	Cabinet, tools	271
Bathroom tissue	163	Cabinets, safety storage	79,271
Batteries	209	Cable clips	120
Battery chargers	204,205	Cable cutters	131,132
Battery testers	205	Cable cutters, hydraulic	248
Belt fasteners	168	Cable pullers	185
Belt, accessories	168	Cable ties	138
Bench saw	232	Cable, wire and ropes	108-113
Bernz-o-matic	249	Cables, accessories	116-122
Bessey clamps	262	Cam and groove fittings	94
Binders, chain	117,129	Can holsters	140
Bins	79	Cans, garbage	165
Bits, screwdriver	317	Cans, safety	79,80
Bits, wood	230	Canthooks	366
Blades, carbide	212	Canvas buckets	266
		Cap lamps	25

C)		C)	
Carabiners	54	Containers, plastic	79
Carbide blades	212	Convex mirrors	79
Carbide burs	225	Conveyor belt fasteners	168
Cardboard rolls	138	Coolers	79
Cargo straps	134,135	Cordages	136
Carpets	166,167	Cords, extension	207
Cartridges and filters	23	Cords, twine	136
Carts, garden	365	Core drills	240,241
Casters	186	Couplers, air	93,95
Caulking guns	244	Couplings, pipe	96,97
C-Clamps	263	Couplings, victaulic type	97
Chain	117,123,124,125	Coveralls	37,40,41,44
Chain binders	117,129	Cranes	177
Chain blocks	182,183,184	Crayons, lumber	138
Chain hoists	182-184	Crow bars	359,360
Chain hooks	127,128	Cups dispensers	79
Chain pliers	132	Cups, foam	79
Chain pullers	182,183	Cups, paper	79
Chain shackles	116	Cut-off-wheels	213-223
Chain slings	114,115	Cutters, bolt	263
Chainsaw mitts	35	Cutters, cable	131,132
Chainsaw pants	35	Cutters, pipe	264
Charger racks	26	Cutters, tube	264
Charger, lamps	26	Cutting discs	217
Check valves	94	Cutting liquid	152
Chipping hammers	247	D)	
Chisels, brick	243	Danger tape	62
Chisels, cold	243	Decidamp	17
Chisels, hammer	238	Defibrillator	8
Chisels, metal	313	Degreaser	153,155
Chucks, drill	228	De-icing salt	165
Circular saw blades	212	Detergent	161
Clamps, Bessey	262	Diamond blades	214,215
Cleaner, hand	161	Die stock handles	226
Cleaners	153,155,160,161	Dies	226
Cleaning stations	8	Diggers	343
Clevis hooks	127,128	Discs, grinding and sanding	216-223
Clips, wire rope	120	Dispensers, cups	79
Clothings	35-41	Dispensers, towels	163
Coat, shop	37	Disposable clothings	38
Combination wrenches	303	Disposable gloves	31
Common nails	96	Dressing tools	219
Compact air system	22	Drift pins	268
Compresses, hot and cold	77	Drill bits	229,230
Compressors	24	Drill chucks	228
Concrete drills	242	Drill presses	232,239
Concrete products	150	Drills, air	234
Cones, traffic	72,73	Drills, magnetic	239
Connectors	207,208	Drills, masonry	242
Construction sprayers	103,105	Drills, wood	230
Construction wrenches	268	Drum equipment	176
Containers, garbage	165	Drum faucets	176

D)		F)	
Drum lifter	181	Flags	46
Drum wrenches	176	Flares, triangular	46
Drum, salvage	78	Flashlights & batteries	209
Duracell batteries	209	Floats, cement	256,260,261
Dust masks	20,21,22	Floor sweeps	164
Dust pans	164	Foam insulation	152
E)		Foam pigs	106,107
Ear plugs	17	Folding rules	264,276
Earmuffs	18,19	Folding workstand	264
Edgers	258,261	Foot valves & strainers	94
Electric chain hoists	184	Forks	344,346,347
Electric cords and connectors	207,208	Funnels	170
Electric spuds	366	G)	
Electric tape	139	Gaffs	70
Electric tools	231,232,239	Galvanizing compound	142
Electric wires	207	Garbage bags	165
Electrods bags	267	Garbage cans	165
Elephant trunk	244	Garden carts	365
Emergency lights	70	Garden hose	103
Environment protection	78	Garden hose, accessories	103
Exhaust hose	90	Gas cans	79,80
Extension cords	207	gate valves	96
Extinguishers	71	Gauges	94
Extractors	316	Glass cases	7
Eye bolts	117,126	Glass cords	7
Eye wash fountain	8	Glasses, safety	3,4,5,6
Eye wash solution	8	Gloves, disposable	31
Eye wash stations	8	Gloves, lineman	34
F)		Gloves, working	27-34
Face masks	22	Goggles	6
Faceshields	7,9	Grass shears	364
Facial tissues	163	Grease equipment	171,172,173
Fall systems	59,60	Grease fittings	173
Fast Orange soap	161	Grease guns	171
Fasteners, belt	168	Grease, spray	155
Faucets, drum	176	Grinding discs	216-223
Felt tip markers	138	Grinding wheels	216-223
Fence, safety	70	Grizzly bar	268
Fiberglass welding helmets	10	Groovers	258,261
Figures, punches	274	Grout	150
Files	210,211	Gun, blow	172
Fill-Rite pumps	174	Guns, caulking	244
Fire extinguishers	71	Guns, soldering	248
Fire hose	91	H)	
Fire hose accessories	91	Hacksaw	212
First aid kits	75	Hacksaw blades	212
First aid products	76	Hallogen lamps	207
Fish tapes	272	Hammer lock, tools and acc.	92
Fittings, boss	93	Hammer, ball-pein	286,355,356
Fittings, hose	93,94,95	Hammer, chipping	247
Fittings, pipe	96	Hammer, claws	283,285
Flagging tape	62	Hammer, club	355,357

H)		J)	
Hammer, nail	283,285	Jig-a-loo	155
Hammer, sledge	358	Job-site tools boxes	271
Hammers	283	Jute, (by the yard)	74
Hammers, mason	355,357	Jute, bags, rolls	74
Hand cleaners	161	K)	
Hand pumps	174	Key rings	252
Hand trucks	175,176	Keys, cabinets	83
Hand winch	178	Kimtowels wipers	163
Handwrap	139	Kito chain hoists	183,184
Hard hats	14,16,18	Kleenex	163
Harnesses	54-57	Klein pliers	265
Hasps	252	Knee pads	261
Hats, safety	14,16,18	Knives, linoleum	256
Hearing, protection	17,18,19	Knives, putty	257
Heaters, propane	250	Knives, retractable	256
Helmets, welding	10	Knives, utility	256
Hinges	253,254	Knives,leather	256
Hoes	342,345,348	L)	
Hoists, chain	182,183,184	Ladders, aluminium	197,198,200,201
Hold down straps	129,245	Ladders, fibreglass	191,192,193
Holders	140,267	Ladders, parts	202,203
Hole saw	242	Ladders, rolling	199
Hoppers	244	Lamps charger	26
Horn, air	70	Lamps, hallogen, fluo	206,207
Hose accessories	94	Lamps, miner	25
Hose clamps	92,93,94,100	Lamps, trouble	206,207
Hose fittings	92-95	Lanterns	209
Hose nozzles	103	Lanyards	54,56,57,58
Hose reels	172	Lawn roller	365
Hose, fire	91	Leak detectors	315
Hose, garden	103	Leather boots	52,53
Hoses	85-91	Leather punches	274
Hot & cold compresses	77	Leggings, chainsaw	35
Hydrant adaptors	91	Lens cleaner	7
Hydraulic cutters	248	Lens, cleaning station	7
Hydraulic equipment	179,180	Levels, aluminium	279,281
Hydraulic jacks	179,180	Levels, line	279,282
Hydraulic pumps	179,180	Levels, torpedo	279,281,282
I)		Lever pullers	182,183,184
Ice scrapers	329	Life jackets	42
Impact sockets	291,292	Life rings	70
Impact wrenches	233	Lifelines	59,60
Inhalator kits	8	Light bulbs	207
Insects repellent	162	Light bulbs	207
Insulation foam	152	Lighters	247
Inverters, power	205	Lights, barricade	70
J)		Lights, revolving	70
Jackall jacks,farm jacks	177	Lineman gloves	34
Jacks, equipment	178,179,180	Linemarking equipment	149
Jacks, hydraulic	179,180	Liners, winter	15
Javel water	161	Links, quick	236
Jerry cans	80	Load binders	117,129

L)		P)	
Locking pliers	308	Padlocks	83,84,252
Lockout stations & tags	82	Pads, knee	261
Lockouts	81,82,83	Pads, sorbent	78
Locks, Master	83	Pails	79
Loctite	158	Paint brushes	143,144,146,147
Lopping shears	363	Paint equipment	149
Lubricant	152,155,159,160	Paint rollers	145,148
Lubricating equipment	171,172,173	Paint thinner	152
Lubricator, in line	94	Paint trays	145,148
Lumber crayons	138	Paint, spray	140,141,142
M)		Paintstick markers	138
Maglite	209	Pallet pullers	177
Magnets	276	Pallet trucks	177
Manhole rails	61	Paper products	163
Markers	138	Paper towels	163
Marking equipments	140	Paper, bathroom tissue	163
Masking tape	139	Parkas	42,44,45
Masks, protective	20,21,22	Parking curb	72
Mason, hammers	355,357	Parts cleaner washers	174
Mason, line	136	Parts cleaning brushes	144
Master locks	83	Peaveys	366
Matting, rubber	165,166,167	Penetrants	153,154
Measures	170	Permatex products	158
Measuring wheels	276	Picks and handles	362
Miner boots	48	Pigs, foam	106,107
Miner's lamps	25	Pins, bull & drift	268
Mirrors, convex	79	Pipe cutters	264
Mirrors, convex	99	Pipe fittings	96,97
Mitre saw	232	Pipe reamers	264
Molass gate valves	176	Pipe sealant	156,158
Mops, pails & wringers	165	Pipe taps	226
Mortars & concrete products	150	Pipe tools	264
Muskol	162	Pipe wrenches	264
N)		Placard holders	64
Nail bars	284,286	Plastic containers	79
Nails	96	Plastic tarps	244,245
Nails sets	296	Plate clamps	181
Nets, safety	74	Pliers, all	243,265,287,307
Nets, trucks	74	Pliers, vise-grip	308
Never-Seez	158	Plugs, electrical	207,208
Nomex, coveralls	41	Plumb bobs	283
Non-sparking tools	270	Pocket C P R mask	8
Nozzles	91	Polyethylene	244,246
Nut drivers	288	Portable bands	275
Nylon slings	133	Portable lamps	209
O)		Posts, T and U metal	63,70
Oil, air, engine	155	Poultry netting	251
Oil-dry	165	Power inverters	205
Overshoes	49,50	Propane burners and acc.	250
P)		Propane cylinders	249
Packaging supplies	138	Propane heaters	250
Paddlers stop and slow	65	Propane hoses	250

P)		R)	
Propane torches	249,250	Rotary burs	225
Protection, environment	78	Rubber boots	48,49,51
Pry bars	260,284	Rubber floats	256,260,261
Pullers, chain	182,183,184	Rubber mallets	286
Pullers, wire	185	Rubber matting	165,166,167
Pulleys	118	Rubber straps	245
Pulling grips	273	Rubber washers	103
Pulp hooks	359	Rubbing brick	260
Pumps, fuel transfer	174	Rules, tapes	276
Pumps, hydraulics	179,180	S)	
Pumps, submersibles	104	Safety boots	48,49,51,52,53
Punch & chisel sets	313	Safety cabinets	79
Punches, arch	274	Safety cans	79,80
Punches, figures	274	Safety check valves	94
Punches, letters	274	Safety fence	70
Punchlock, clamps & tools	92	Safety fence	70
Putty knives	257	Safety glasses	3,4,5,6
Q)		Safety harnesses	54-57
Quick links	236	Safety hasps	252
R)		Safety hats	14,16,46
Radar lights	209	Safety lamps	209
Rags	165	Safety lanyards	54,56,57,58
Rail winches	61	Safety lights	209
Raincoats	38,39	Safety nets	74
Rainsuits	38,39	Safety signs	63,66,68,69,72
Rakes	340,341	Safety tags	66,67
Rap-Arounds	247	Safety triangles	46
Ratchet sets	294,298,302	Safety vests	42,43,44,45,47
Reamers	264	Safety wire (Whipchek)	94
Rebar shears	269	Salt, de-icing	165
Record tools	263	Sanding discs	213
Reel stands	272	Sandpaper	220
Reel, tie wire	243	Sanitary products	163
Reflector flares	46	Saw, electric	232
Regulators	172,236	Saw, hand, back	284
Repellent, insects	162	Saw, miter	232
Rescue blankets	77	Scaffold	187
Rescue kit	60	Scaling bars	266
Rescue sheet	77	Scissors	274
Resuscitation equipment	8	Scraper bars	348
Revolving lights	70	Scrapers, ice, sidewalk	329
Ridgid tools	264	Scrapers, wall	257
Riveters	274	Screeds	260
Rivets & guns	274	Screwdrivers bits	317
Rollers, lawn	365	Screwdrivers, hand	289
Rolling ladders	199	Sealants	244
Roof rakes	336	Self retracting lifeline	59
Roofer's kits (harness)	60	Shackles	116,119,121
Rope blocks	118	Shackles, chain	116
Rope grabs	60	Shimstock	96
Rope, wire	108-113	Shipping tags	138
Ropes, poly, nylon, manilla	136	Shop coats	37

S)	
Shop coats	37
Shop rolls	220
Shop-vac	160
Shovels	318,329
Sign mounting brackets	101,102
Signs	63,69,72
Silicone sealant	244
Sledge hammers	352,353,354
Slings, chain	114,115
Slings, nylon	133
Slings, wire rope	115
Slow moving signs	63
Snatch blocks	118
Snips	309
Snow fence	70
Snow fences	70
Snow pushers	330,334,337,339
Snow sleigh shovels	335
Soap dispensers	163
Soap, hands	161
Soapstone and holders	247
Sockets	291,292
Sockets sets	294,298,302
solder	248
Soldering guns	248
Sorbent pads	78
Spark lighters	247
Spectacles	3,6
Speed bumps	72
Speed bumps	72
Spill kits	78
Spray paint	140,141,142
Sprayers	103,105
Spring guns	237
Springklers	103
Spud, electric	366
Squares,all	279,280
Squeegees, floor	165
Stamps, letters & figures	274
Staplers & staples	243
Steel T posts	70
Stepladders, aluminum	194,195,196
Stepladders, fiberglass	188,190
Stone dressers	219
Strainers	94
Strap winches	135
Strapping Band-it	98-102
Strapping system	137
Strapping, plastic and tools	137
Strapping, steel and tools	137
Straps, cargo	174,175
Stretchers	77

S)	
Striking wrenches	304
Striping machines	140
Structural wrenches	268,312
Submersible pumps	104
Surveyor's tape	62
Swagers	130
Sweat bands	11,15
Sweeping compound	164
Swivels	116,273
T)	
Tags & wires	138
Tags, safety	66,67
Tampers	359
Tap handles	226
Tape dispensers	139
Tape, barricade	62
Tape, cloth	139
Tape, duct	189
Tape, electric	139
Tape, filament	139
Tape, masking	139
Tape, measuring	275,276,277,278
Tape, packing	139
Tape, surveyors	62
Tape, teflon	139
Taps & dies	226
Target products	153
Tarps, plastic	244,245
Testers, batteries	205
Thermometers	314
Thinner, paint	152
Threaders	264
Threadlocker	156,158
Tie down straps	129,245
Tie wire reels	269
Ties, cable	138
Timber carriers	366
Tip cleaners	247
Tire inflators	172
Tools boxes	295,296,297
Tools buckets	266
Tools, 1000 volts	310,311
Tools, electric	231,232,239
Tools, miniatures	248
Torches	249,250
Torque wrenches	305,306
Towels dispensers	163
Towels, paper	163
Traffic cones	73
Traffic flags	46
Traffic signs	63,64,65,72
Traffic vests	43,44,45,47

T)		W)	
Transfer pumps	174	Wheel, measuring	276
Trays, paint	145	Wheelbarrows	367
Tree trimmers	363	Wheels, grinding	216-223
Triangles, safety	46	Whipchek	94
Tripods	264	Winch, boat	178
Trolleys	181,184	Winches, boat	178
Trouble lamps	206	Windshield washer	152
Trowels	258-261	Winter liners	15
Truck nets	74	Wipers	165
T-Shirt, safety	45,47	Wire brushes	224,225
Tube cutters	264	Wire cutters	131,132
Turnbuckles	117,122	Wire cutters	207,243,251
Twine, binding	136	Wire pullers	185
Twine, waxed	136	Wire rope blocks	118
Twist drills	229,230	Wire rope slings	115
Tyvek (disposable clothing)	38	Wire ropes	108,113
U)		Wire ties	138
Unibit	226	Wire twisters	138
Universal couplings	93	Wire wheels	224
V)		Wire, piano, music	243
Vacuum cleaners	169	Wire-rope accessories	116,122
Vacuum hose	90	Wire-rope clips	116,120,122
Valves, brass & boss	93	Wisk brooms	164
Valves, Butterfly	97	Wood bits	230
Valves, drum faucets	176	Wood handles	164
Valves, foot	94	Work clothings	37
Valves, standard gate	96	Work gloves	27-34
Vests, life	42	Work lamps	206
Vests, traffic	43,44,45,47	Wrecking bars	360,361
Vibrators	151	Wrenches, ajustable	312
Victaulic type fittings	97	Wrenches, construction	268
Vise-grip pliers	308	Wrenches, erection	268
Vises, bench	263,264	Wrenches, pipe	264,312
W)		Wrenches, striking	304
Wall scrapers	257	Wrenches, structural	312
Wands, marking	140	Wrenches, torque	305
Washers, rubber	103	Z)	
Water hoses	87,88,89	Zinc, cold galvanizing	142
WD 40	158		
Wedge sockets	117,120		
Wedges	247		
Welder's clothings	36		
Welders gloves	32		
Welder's goggles	13		
Welders, helmets	10,11,12		
Welding accessories	247		
Welding blankets	13		
Welding hammers	247		
Welding lenses & filters	13		
Welding respirators	11		
Wet floor stand	62		
Wheel dresser	219		



Comes with Two Sets of Temple Ends



Comes with Two Flexi-Fit Soft Nose Piece (Regular and Narrow)



N-VISION™



The most innovative safety glasses on the market created with the same technology used in aerospace and automotive research and development. The N-Vision 5600 is available with two types of temple ends (straight and curved) and two lens systems, T5650 with Universal Comfort Bridge and T5655 with 2 soft Flexi-Fit nose pieces. 4A Coating, Anti-Fog, Anti-Scratch, Anti-Static and Anti-UV at 99.9%. Replacement lenses are available. Other lens colors are also available.

T5655 SERIES - SOFT FLEXI-FIT NOSE PIECE

Lens	Black / Grey Frame	Grey / Black Frame	Blue / Grey Frame
Clear	T56555B	T56555GRY	T56555BL
Smoke	T56555BS	T56555GRYS	T56555BLS
Mirror*	T56565BM	—	—
I/O Mirror*	T56565BTCG	—	—

*Mirror & I/O Mirror lenses are not fog free



Comes with Two Sets of Temple Ends



T5650 SERIES - UNIVERSAL COMFORT BRIDGE

Lens	Black / Grey Frame	Grey / Black Frame	Blue / Grey Frame
Clear	T56505B	T56505GRY	T56505BL
Smoke	T56505BS	T56505GRYS	T56505BLS
Amber	T56505BA	—	—
I/O Mirror*	T56515BTCG	—	—

*I/O Mirror lenses are not fog free

LIGHTNING



State-of-the-art protective spectacles that are so stylish they call out to be worn. Discover the best all around features available today. Provided with 2 Flexi-Fit soft nose pieces. 4A Coating, Anti-Fog, Anti-Scratch, Anti-Static and Anti-UV at 99.9%. Replacement lenses available.

Part #	Lens Color	Frame Color
T65005	Clear	Black
T65005S	Smoke	Black
T65005A	Amber	Black
T65015TCG	I/O Mirror*	Black

*I/O Mirror lenses are not fog free

LIGHTNING PLUS



Setting a new standard in eye protection. Consists of a new panoramic lens for a wide unobstructed field of vision, unique bowed temples, 2 Flexi-Fit soft nose pieces, comes in four exciting frame colors. 4A Coating, Anti-Fog, Anti-Scratch, Anti-Static and Anti-UV at 99.9%. Replacement lenses available.

Lens	Black Frame	Blue Frame	Silver Frame	Bronze Frame
Clear	T65505B	T65505BL	T65505S	T65505BR
Smoke	T65505BS	T65505BLS	T65505SS	T65505BRS
Mirror*	T65505BM	—	—	—
I/O Mirror*	T65515BTCG	—	—	—

*I/O Mirror lenses are not fog free

New Frame color



Prescription Insert will convert the N-Vision T5655, Lightning and Lightning Plus into a prescription safety glass.

Lens	Description
65RXII	RX Insert

Note: N-Vision, Lightning and Lightning + glasses sold separately



An outstanding safety or sport spectacle with face-fitting curve and "extreme" styling. 4A Coating, Anti-Fog, Anti-Scratch, Anti-Static and Anti-UV at 99.9%. Replacement lenses available.

T5700 SERIES - CURVED EXTENSIBLE TEMPLE

Lens	Black Frame	Blue Frame	Grey Frame
Clear	T57005B	T57005BL	T57005GRY
Smoke	T57005BS	T57005BLS	T57005GRYS
Amber	T57005BA	—	—
Mirror*	T57005BM	—	—

T5800 SERIES - STRAIGHT TEMPLE

Lens	Black Frame	Blue Frame	Grey Frame
Clear	T58005B	T58005BL	T58005GRY
Smoke	T58005BS	T58005BLS	T58005GRYS
Amber	T58005BA	—	—
Mirror*	T58005BM	—	—

*Mirror lenses are not fog free

PULSAR

Stylish European shape with a 8.50 base curve dual lens design for wrap-around coverage. Adjustable soft nose piece and temple arms for increased comfort. 3A Coating, Anti-scratch, anti-static and anti-UV at 99.9%.

Lens	Burgundy Frame	Translucent Grey Frame
Clear	T80005BU	T80005TK
Smoke	T80005BUS	T80005TKS
Amber	T80005BUA	T80005TKA
I/O Mirror	T80005BUTCG	T80005TKTCG

*I/O Mirror lenses are not fog free

THE EDGE



Canada's #1 selling eyewear. Single-piece polycarbonate lens with a 9-based curve for maximum peripheral vision, 4A Coating, Anti-Fog, Anti-Scratch, Anti-Static and Anti-UV at 99.9%, comes complete with 2 sets of temple ends and unique "quick-change" lens replacement system. Replacement lenses available.

Lens	Black Frame	Blue Frame	Grey Frame
Clear	T56005B	T56005BL	T56005GRY
Smoke	T56005BS	T56005BLS	T56005GRYS
Amber	T56005BA	—	—
Mirror*	T56005BM	—	—
I/O Mirror	T56005BTCG	—	—

*Mirror & I/O Mirror lenses are not fog free



Dual-lenses with a low profile design that offers excellent coverage, the frame comes with vented sides. 4A Coating, Anti-Fog, Anti-Scratch, Anti-Static and Anti-UV at 99.9%. Replacement lenses available.

Part #	Lens Color	Frame Color
T61005B	Clear	Black
T61005BS	Smoke	Black



ILLUSION

Stylish low profile lens designed with excellent wrap around coverage. Lenses are protected by North's exclusive 4A Coating, Anti-Fog, Anti-Scratch, Anti-Static and Anti-UV at 99.9%. Other lens colors available.

Part #	Lens Color	Temple
T15005	Clear	Black
T15005S	Smoke	Black
T15005A	Amber	Black
T15005M	Mirror*	Black
T15005IR3.0	IR3.0	Black
T15005IR5.0	IR5.0	Black

*Mirror lenses are not fog free

180 SLIMLINE



Popular low profile shape with a high 9 base curve for better coverage and wide field of view. Made of lightweight non-conductive high impact polycarbonate material. Soft temple pads for better comfort.

Part #	Lens Color	Temple Pads Color
T1300	Clear	Blue
T1301	Smoke	Hi-Viz Orange
T1302	Amber	Grey

SQUIRE



Lightweight 100% nylon frame with one piece wrap around lens. 3A Coating, Anti-scratch, anti-static and anti-UV at 99.9%.

Part #	Lens Color	Temple / Frame
T16055	Clear	Black
T16055S	Smoke	Black
T16055A	Amber	Black

REBEL T8100 SERIE



Attractive spectacle for both men and women with its contemporary look and excellent fit. 3A Coating, Anti-scratch, anti-static and anti-UV at 99.9%.

Part #	Lens Color	Temple Color
T81005	Clear	Black
T81005S	Smoke	Black
T81005A	Amber	Black
T81005TCG	I/O Mirror	Black

SQUIRE FRAMELESS



Inspired by our very popular Squire spectacle, the new Squire Frameless offers the same classic look in an economical frameless design. 3A Coating, Anti-scratch, anti-static and anti-UV at 99.9%.

Part #	Lens Color	Temple Color
T16355	Clear	Black
T16355S	Smoke	Black



TRITON™

Built from high impact Polycarbonate, the Triton meets ANSI Z87.1 and is CSA certified to the current Z94.3 Eye & Face Protector standards. 3A Coating, Anti-scratch, anti-static and anti-UV at 99.9%.

Part #	Lens Color	Temple Color
T12005	Clear	Translucent Grey
T12005S	Smoke	Translucent Grey
T12005TCG	I/O Mirror	Translucent Grey

OG T1100 SERIE



Over the glasses type spectacles that fits over most prescription eyewear. Offers very good coverage wide field of view. 4A Coating, Anti-Fog, Anti-Scratch, Anti-Static and Anti-UV at 99.9%.

Part #	Lens Color	Temple / Frame
T11005	Clear	Clear
T11005S	Smoke	Smoke
T11005A	Amber	Amber

SAFESPLASH 315



Indirect, cap vented goggle for splash situations.

Part #	Body	Lens
315	Green	Clear

PROTECTOR 300



Direct ventilation, clear high-impact lens.

Part #	Body	Lens
300	Green	Clear

VISITOR™



These spectacles offer premium protection to plant visitors, a large lens that provide a wide viewing field and the exclusive interlocking sideshield system offers all-around protection from flying particles. Meets ANSI Z87.1 and is CSA certified to the current Z94.3 Eye & Face Protector standards.

Part #	Lens Color	Sideshields Color
90S	Clear	Clear

ROYALE UV50



The Royale UV50 has a soft lightweight PVC frame and fits over even the largest prescription eyewear. 4A Coating, Anti-Fog, Anti-Scratch, Anti-Static and Anti-UV at 99.9%.

Part #	Body	Lens
UV50LG/N	Light gray	Clear

GOGGLE CLIP



The GC2000 goggles clips are made of non-conductive and robust plastic. The GC2000 clips will fit all North hard hats as well as most of our competitors helmets.

Part #	Description
GC2000	Goggle clip - 3 per bag



FULL FACE PROTECTION

Both models comes with Ratchet adjustment.

Part #	Description
KHG4001	Headgear with quick-change system
KHG5001	Headgear with protected holding system

Note: Visor sold separately



FACESHIELD VISOR

North offers the widest variety of faceshields, visors and screens, in all shapes and sizes. Fits any headgear that accepts the universal slot design.

Part #	Size	Form	Material
A8150/40	8" x 15-1/2"	Flat	PET-G Copolyester
A8152/40	8" x 15-1/2"	Flat	Polycarbonate
A8154	8" x 15-1/2"	Pre-Formed	Polycarbonate

CORDS & HOLDER



Part #	Description
SS51	Spec-cord holders; Comfortable & economical, black color
SS55B	Long cord holder - Hold your glasses on your chest when not required, black color

SPECTACLE CASES



Part #	Description
86	Snap closing top vinyl case with spring pocket clip & fastening snap
87	Large size nylon spectacle case with double belt loop & zipper closure

FACESHIELD BRACKET

CP5005

CP5004



Part #	Fitting to hat
CP5005 (Plastic)	Universal, Most Hats
CP5006 (Plastic)	A49, A49R, A119R
CP5004 (Alum.)	A79, A79R, Most Hats

LENS CLEANING STATIONS



Part #	Description
LCS2	Disposable lens cleaning station including: (1) 16 oz (500 ml) bottle of Anti-Fog lens cleaner and (2) boxes of tissue

LENS CLEANER



Part #	Description
10204	4oz / 114ml Lens Cleaner
10208	8oz / 227ml Lens Cleaner
102016	16oz / 455ml Lens Cleaner
1025	Lens cleaning tissues - 280/box
T1025T	Lens cleaning towelette - 100/distributor box

FORESTRY KITS



Part #	Description
FK12	Mid range forestry kit - Includes: A79R orange, FS03, EM2266
FK13	Economy forestry kit - Includes : A79 red, FS03, EM4157



EYEWASH STATION

Part #	Description
E/A3825	Single eyewash station with (1) empty bottle of 32 oz (1 litre)
E/A3840	Single eyewash station with (1) full squeeze bottle of 32 oz (1 litre)
E/A3835	Empty eyewash bottle of 32 oz (1 litre) with spill spout and eye cup



EYEWASH SOLUTION

Part #	Description
E/1507ISO	Isotonic solution - sterile - 8 oz (250 ml)
E/1507AISO	Isotonic solution - sterile - 16 oz (500 ml)
E/1507BISO	Isotonic solution - sterile - 32 oz (1 liter)
E/1507CISO	Isotonic solution - sterile - 128 oz (4 liters)



EMERGENCY EYEWASH FOUNTAIN

Dependable, low cost emergency eye wash fountain, easily installed in any sink or basin. Does not require a plumber or special installation.

Part #	Description
E/8125	Emergency eyewash fountain



GRAVITY EYEWASH FOUNTAIN

Supplied with wall bracket and bacteriostatic additive to permit storage of water for up to six months. Measurements: 12" high, 22" wide, 10" deep.

Part #	Description
7501	Portable gravity eyewash fountain
9082	Water additive, 8 oz, 4 unit per case



AUTOMATED EXTERNAL DEFIBRILLATOR

An Automated External Defibrillator (AED) is a medical device that automatically analyzes a cardiac arrest victim's heart rhythm and advises a user to deliver a shock when appropriate.

Part #	Description
D/9300E501	Automated External Defibrillator
D/9131001	Patented pre-connected electrodes
D/1686000001	Carrying Bag for AED G3

Note: Other accessories are also available



AED TRAINER

Part #	Description
D/1803010001	Automated External Defibrillator Trainer
D/9035002	Adult training electrodes



RESCUE BREATHER

A pocket size "Physical barrier" for Mouth-to-Mouth resuscitation. It has been designed as a "First Response Device". One-way valve reduces the risk of cross contamination.

Part #	Description
218410001	C.P.R. shield with one-way valve in ziplock bag



POCKET CPR MASK

Easy to carry at work in your car. This mask has a one-way valve, filter, headstrap, oxygen intake, in oval-shaped hard case. Ready to use in case of emergency.

Part #	Description
EMS1025	Pocket CPR Mask in oval-shaped hard case

ARC FLASH SERIES DUAL CROWN PROTECTIVE MASKS



ARCFlash
NFPA 70E

FM400DCAF25

FM70DCAF25E2

- Full face and neck protection
- Broader, deeper 4" crown and chin protectors
- Crown and chin protectors molded from NORYL
- Available in dual crown ratchet headgear model or dual channel cap peak mounting bracket with chin protector
- High performance injection molded, preformed optically correct propionate windows with 25 cal ratings when used as tested
- Both models meet CSA and NFPA 70E, category 1 or 2

Part #	Description
FM400DCAF25	Dual crown protective mask with arc flash 25 cal window
FM70DCAF25E2	Dual Crown Protective mask with arc flash 25 cal window Cap style - Includes E2RW01A000
FM70DCAF25SE2	Dual Crown protective mask with arc flash 25 cal window cap style - Includes SE201A000

WARNING: Arc Flash products have a CAL rating of 25 only when worn as tested and shown in the image. Wearing in any other way, or substituting any other components voids the CAL rating and could result in serious injury. Always wear appropriate and approved basic eye protection under Arc Flash safety masks. Do not use for welding.



F300CSA
FACESHIELD SHOWN WITH 4118CL WINDOW (SOLD SEPARATELY)

F500CSA
FACESHIELD SHOWN WITH 4199IRUV5 WINDOW (SOLD SEPARATELY)

F400CSA
FACESHIELD SHOWN WITH 4178CL WINDOW (SOLD SEPARATELY)

From

FACESHIELD WINDOWS

Fibre-Metal faceshield windows are injection molded from propionate, which is superior to other window materials in every significant performance characteristic. They are preformed at the factory to the exact curve of our crown protectors for easy installation, an exact fit and a perfect seal against dust, dirt and debris. All HIGH PERFORMANCE windows are .060" thick for an extra margin of protection.

Part #	Color	Size
4118CL	Clear	8" x 11"
4178CL	Clear	8" x 16 1/2"
4199CL	Clear	9 3/4" x 19"
4118DGN	Dark Green	8" x 11"
4178DGN	Dark Green	8" x 16 1/2"
4199DGN	Dark Green	9 3/4" x 19"
4178IRUV3	IR3.0	8" x 16 1/2"
4199IRUV3	IR3.0	9 3/4" x 19"
4178IRUV5	IR5.0	8" x 16 1/2"
4199IRUV5	IR5.0	9 3/4" x 19"
4178IRUV8	IR8.0	8" x 16 1/2"
4178GD	Gold	8" x 16 1/2"
4199GDTVGY	Gold	9 3/4" x 19"

DUAL CROWN FACESHIELDS



by **NORTH**



FM400DCCLC

Part #	Description
FM400DCCLC	F-400 4" dual crown with 6750-C clear window & chin guard complete, 3-C ratchet headgear
FM4400DCCLC	F-400 4" dual crown with 6750-C clear window & chin guard complete, 4001 Mounting Cups, Attach to Quick-Lok Caps and 6000 Blades for Slotted Caps
FM5400DCCLC	F-400 4" dual crown with 6750-C clear window & chin guard complete, 5000 Speedy Loop, Attach to Protective Caps
F3400CGCL	Replacement Clear Chin Guard for all Dual Crown Faceshields

HIGH PERFORMANCE CROWN PROTECTOR

Made from NORYL, they are stronger, more durable and more heat resistant than ordinary faceshields. They contain our exclusive Channel Grip System, which mounts windows and locks them in place in a deep recessed channel to form a perfect seal from dust, dirt and debris.

Part #	Description
F300CSA	3" Crown protector complete with 3SR Headgear
F400CSA	4" Crown protector complete with 3-C Headgear
F500CSA	7" Crown protector complete with 3-C Headgear
F5400	4" Crown protector complete with Speedy Loop
F5500	7" Crown protector complete with Speedy Loop
F4400	4" Crown protector complete with Quick-Lok
F4500	7" Crown protector complete with Quick-Lok

Faceshield Series						
F300CSA	F400CSA	F500CSA	F5400	F5500	F4400	F4500
3						
	3	3	3	3	3	3
	3	3	3	3	3	3
3						
	3	3	3	3	3	3
	3	3	3	3	3	3
	3	3	3	3	3	3
	3	3	3	3	3	3
	3	3	3	3	3	3
	3	3	3	3	3	3
	3	3	3	3	3	3

TIGERHOOD® FUTURA ADF THERMO PLASTIC WELDING HELMET

2001BM10



2999BV913SR

Tigerhood Futura continues to set the standard for performance and innovation with the introduction of models equipped with quality, reliable auto darkening filters that take advantage of advances in ADF technology.

Part #	Description
2001BM10	Welding helmet to be used with 2x4 ADF lens
2999BV913SR	Welding helmet to be used with 5x4 ADF lens

TIGERHOOD® FUTURA THERMO PLASTIC WELDING HELMET

2006SRCSA



2090SRCSA

The Tigerhood Futura represents the latest in welding helmet technology and performance. An innovative, streamlined design combined with an exceptionally high performance material help welders make more and better welds. Other color also available.

Part #	Description
2006SRCSA	Welding helmet with 2" x 4-1/4" flip front and 3-C ratchet headgear
2090SRCSA	Welding helmet with 5-1/4" x 4-1/2" fix front and 3-C ratchet headgear

TIGERHOOD® CLASSIC THERMO PLASTIC WELDING HELMET

906GY-CSA



990GYCSA

Tigerhood Classic contains the features that make lightweight thermoplastic welding helmets popular with today's welders. What makes it stand out is its performance and comfort enhancing extras that help welders produce more with fewer injuries. Other color also available.

Part #	Description
906GY-CSA	Welding helmet with 2" x 4-1/4" flip front 3-C ratchet headgear
990GYCSA	Welding helmet with 4-1/2" x 5-1/4" fix front and 3-C ratchet headgear

PIPELINER® LEATHER WELDING HOOD



870

Top quality, tough, flexible chrome leather hoods for use in hard to get to areas where there is no room for standards helmets. Liftfront glassholder. Screened ventilation ports.

Part #	Description
870	Leather welding helmet with 2" x 4-1/4" lift front for hard to reach area

PIPELINER® FIBERGLASS WELDING HELMET



110PWECSA

Molded from SUPERGLAS PLUS®, a material formulated for lightweight and strength, PIPELINER provides everything pipe welders need in a helmet to be safe and productive under the harshest welding condition. Compact design allows access to areas where there is no room for a standard helmet.

Part #	Description
110PWECSA	Welding helmet with 2" x 4-1/4" fix front and Constant-fit rubber headband
1CP	Replacement headgear

WELDING HELMET AND FACESHIELD PROTECTIVE CAP COMPONENTS



Model 5000 Speedy loop provides easy on/off welding helmet and faceshield mounting on protective caps. Fully adjustable to better fit Fibre-Metal caps and major competitive Brands. Model 4000 Quick-Lok provides more permanent mounting for longer term or high activity applications.

Part #	Description
4000	Quick-Lok Kit set
FM4001	Quick-Lok female Helmets and Faceshield
4002	Quick-Lok male Caps
5000	Speedy Loop

New



999BV913DS

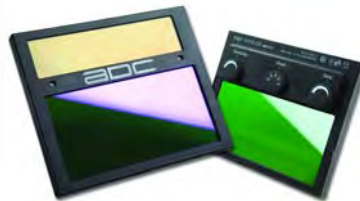

FMPBV913DSADC

TIGERHOOD® 999 ADC WELDING HELMET

Fibre-Metal's ADC lens provides workers with an unprecedented field of vision, in addition to helping increase productivity, our ADC lens diminishes eye fatigue and or injury.

Part #	Description
999BV913DS	Welding Helmet, 90 x 110 mm, Variable Shades 9-13 auto-darkening filter plate, 3C Headgear, Silver
4999BV913DS	Welding Helmet, 90 x 110 mm Variable Shades 9-13 auto-darkening filter plate, 4001 Quick Lok (R), Silver
5999BV913DS	Welding Helmet, 90 x 110 mm, Variable Shade 9-13 auto-darkening filter plate, w/5000 Speedy Loop®, Silver
FMPBV913DSADC	Replacement ADF Filter, Variable Shade 9-13, ADC technology, Fits 999 and 2999 Series Welding Helmets

BEANIES



Part #	Description
FMBEANIE/007	100% Cotton Beanie

7600 SERIES FULL FACEPIECE WELDING RESPIRATOR



Silicone full facepiece with welding attachment and 5 strap head harness and welding assembly.

Part #	Description
760008AW	Medium full facepiece
760008ASW	Small full facepiece

5400 SERIES FULL FACEPIECE WELDING RESPIRATOR



Elastometric full facepiece with welding attachment and 4 strap head harness and welding assembly.

Part #	Description
54001W	Medium full facepiece
54001SW	Small full facepiece

COMFORT ENHANCING SWEAT BANDS



Circulating air evaporates sweatband moisture for cooling effect.

Part #	Description
FM44T	Soft terry cloth sweat band
FM66	Shearling wool sweat band
FM67	Soft grain leather sweat band
FM68	Soft absorbent cotton sweat band



BP1000 SERIES BACKPACK ADAPTER

Part #	Description
BP1002	Backpack adapter for air-purifying facepiece
BP1002H	Harness for Backpack BP1002
BP1002HFR	Harness FR for Backpack BP1002

* Half-mask and cartridges sold separately



FM500X3
VISOR SOLD SEPARATELY

FM500X4
VISOR SOLD SEPARATELY

FM500X1
VISOR SOLD SEPARATELY

FMX FULL GRAPHIC FACESHIELD

Exclusive overlay designs; heat and scratch resistant • Oversized 7" heat resistant crown for extra protection • Cam-locking channel grip design seals against sparks and debris • Accommodates Fibre-Metal window sizes up to 19" x 9.75" • Adjustable non-slip/non-strip ratchet headgear • Lifetime Limited Warranty: visor/headgear

Part #	Description
F500X1	FMX Flame
F500X3	FMX Wire Burner
F500X4	FMX Spirit of America



E2RWX2

E2RWX3

E2RWX1

FMX FULL GRAPHIC PROTECTIVE CAPS

Exclusive overlay designs; heat and scratch resistant • Smooth thermoplastic crown deflects impacting objects • Exclusive Eight-point suspension disperses impact energy • Adjustable non-slip/non-strip ratchet headgear for ultimate comfort and fit • Lifetime Limited Warranty: shell/headgear

Part #	Description	Suspension
E2RWX1	FMX Flame	Ratchet
E2RWX2	FMX Demon	Ratchet
E2RWX3	FMX Wire Burner	Ratchet
E2RWX4	FMX Spirit of America	Ratchet
E2SWX1	FMX Flame	Swingstrap
E2SWX2	FMX Demon	Swingstrap
E2SWX3	FMX Wire Burner	Swingstrap



2999BV913X1

2999BV913X2

2999BV913X3

FMX FULL GRAPHIC WELDING HELMET

Craftsmen welders across the country were asked to help create the next generation welding helmet. The result: new Fibre-Metal FMX – premium quality welding helmets, with the Xtra features welders want: • Lifetime warranty on helmet and headgear • Superior ADF lens with industry-leading 2-year warranty • Lightest-weight full-size helmet available • Proven "3-C" headgear for all day comfort • Professional, full-wrap, heat and scratch resistant graphics • Packaging reflecting FMX quality and performance

Part #	Description
2999BV913X1	FMX Flame
2999BV913X2	FMX Demon
2999BV913X3	FMX Wire Burner

FIBERGLASS WELDING BLANKETS



Fibre-Metal welding blankets are durable, double kevlar stitched hemming with grommets. Temperature rating of 1000°F.

Part #	Fabric	Size
FMFBC246X6	24 oz neoprene coated	6' x 6'
FMFBC246X8	24 oz neoprene coated	6' x 8'

WELD FILLET GAGE



Blades pivot for easy measuring of eleven most specific fillet dimensions. Measures concave or convex seams. Stainless steel blades, etched increments. 1/8" thru 1" and metric equivalents. Fits in 4 1/2" x 2" case. Carry in pocket.

Part #	Fabric
WFG	Weld Fillet Gage

FLEXIBLE/RIGID FRAME WELDING GOGGLES



Fibre-Metal offers a wide variety of flexible or rigid frame gas welding and cutting goggles. The plastic frames hug facial contour for an extremely comfortable fit. Ventilated for effective cooling and evaporation. Equipped with durable elastic headbands. Shade #5 filter and clear cover plate included.

Part #	Description
VG600SH5	Reinforced flexible frame 2" x 4-1/4" fix front cover goggle with hooded vents
VG200SH5	Flexible frame 2" x 4-1/4" lift front cover goggle with hooded vents
VGSH5	Adjustable fit rigid frame, 50mm cup goggle with baffled vents
VG800SH5	Reinforced flexible frame, 50 mm lift front goggle with vents

WELDERS MAGNIFYING LENS



Part #	Type	Shade	Size
E3651.5	Polycarbonate		2-1/4" x 4-1/4"
E3651.75	Polycarbonate		2-1/4" x 4-1/4"
E3652	Polycarbonate		2-1/4" x 4-1/4"
E3652.5	Polycarbonate		2-1/4" x 4-1/4"
E3641.5	Glass		2-1/4" x 4-1/4"
E3641.75	Glass		2-1/4" x 4-1/4"
E3642	Glass		2-1/4" x 4-1/4"
E3643	Glass		2-1/4" x 4-1/4"

REPLACEMENT FILTER PLATES AND COVER LENS

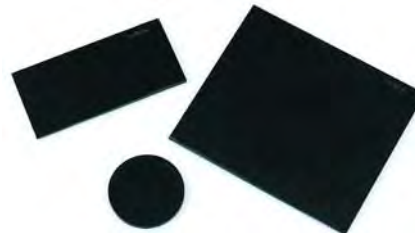

HEAT TREATED GLASS FILTER PLATES

Part #	Type	Shade	Size
GP-241H-9	Glass	9	2" x 4-1/4"
GP-241H-10	Glass	10	2" x 4-1/4"
GP-241H-11	Glass	11	2" x 4-1/4"
GP-451H-9	Glass	9	4-1/2" x 5-1/4"
GP-451H-10	Glass	10	4-1/2" x 5-1/4"
GP-451H-11	Glass	11	4-1/2" x 5-1/4"

NOTE: Shades 5 & 8 and shades 12 to 14 also available. Polycarbonate shaded lens are also available.

CLEAR REPLACEMENT LENS

Part #	Type	Shade	Size
NPC-242	Polycarbonate	Clear	2" x 4-1/4"
NPC-452	Polycarbonate	Clear	4-1/2" x 5-1/4"
NP-242	CR39	Clear	2" x 4-1/4"
NP-452	CR39	Clear	4-1/2" x 5-1/4"



Type 1/Class E

Hard hat with accessory slots, rain trough and 4-points nylon suspension.

Part #	Suspension
A79	Pinlock
A79R	Ratchet

NEW CSA Z94.1-05 INDUSTRIAL PROTECTIVE HEADWEAR STANDARDS

CSA has recently launched a revised version of the "Industrial Protective Headwear" standard Z94.1-05. This new standard classifies protective headwear into two types. Type 1 provides impact and penetration protection on the crown (top) only. Type 2 offers impact and penetration protection on the top as well as lateral protection (sides).

The new standard also requires that a hazard assessment be performed in the work place. This new standard includes a guide on how to perform a workplace hazard assessment. If no hazard assessment is conducted, the worker must default to the highest protection level which is a type 2, class E protective helmet.

The new standard still covers dielectric properties. Class E rating (Electric), is a hard hat that must pass an electrical test that protects up to 20,000 volts. For a Class G rating (general purpose) the conductivity test must qualify with a protection limit of 2,200 volts. Lastly, a Class C rating, is a hard hat manufactured of conductive material or a hard hat that does not meet Classes E or G. This would only be suitable in areas where there is no risk of electrical hazards.



Type 2 / Class E

Canada's #1 seller, hard hat with foam liner to protect from lateral impacts. Choice of unique Quick-Fit or ratchet four-point suspension. Dielectric HDPE shell. Lightweight, modern styling, rain trough and accessory slots.

Part #	Suspension
A89	Quick-Fit
A89R	Ratchet



ANSI Type 1

A versatile new short peak hard hat, featuring strength and rigidity in a lightweight hard hat.

Part #	Suspension
A29R	Ratchet



Wide brim HDPE hard hat for protection from the sun's harmful UV rays, rain and falling debris.

Part #	CSA/Type	Suspension
A119R	Type2/Class E	Ratchet - 6point
A49R	Type1/Class E	Ratchet - 6point

BUMP CAP



Low-hazard bump cap, well ventilated and lightweight for total comfort. Not approved.

Part #	Suspension
BC89	Pinlock
BC86	Pinlock

**PERSONALIZE YOUR CORPORATE IMAGE
PAD PRINTING**

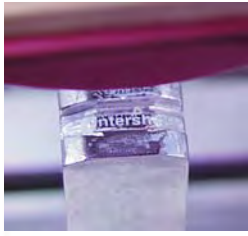

Using a flexible rubber pad that can fit the exact shape of the hat, we use a highly resistant ink to print your logo on almost any part of the shell.

Request our NEW Personalization Brochure!

**WELDER'S CAP AND
FIREFIGHTER BALACLAVA**



WC80



FH157

Part #	Description
WC80	Welder's cap with neck protector, 100% cotton, white
FH157	Short balaclava, Nomex, white

SWEATBAND



Part #	Description
450SB/25	Foam sweatband with elastic, pack of 25

HARD HAT WINTER LINERS



WL12FP



WL1



WL40RBSP

Made from quality materials and designed to fit most hard hats.

Part #	Color	Material	Face Warmer
WL1	Black	Cotton	No
WL12	Royal Blue	FR Cotton	No
WL12FP	Royal Blue	FR Cotton	Yes
WL40RBSP	Royal Blue	Nomex	Yes
WL80NVB	Navy Blue	Nylon/Cotton	No
WL81/1RB	Royal Blue	Westex Proban	Yes
WL82RB	Royal Blue	Nomex	No
WL82/1RB	Royal Blue	Nomex	Yes

Hard Hat Color Table 2009

Group	Models	01	02	03	04	05	06	07	08	09	10	11	12	13	14	15	16	17	18	19	20
		white	yellow	orange	dark green	hi-viz red	light blue	sky blue	navy blue	grey	beige	black	brown	gold	avocado	red	green	army	royal blue	maroon	burgundy
A	A29R	✓	✓	◇	◇	✗	✗	◇	◇	◇	✗	◇	◇	✗	✗	✗	◇	✓	◇	✗	✗
A	A79, A79R	✓	✓	✓	✓	✓	◇	✓	✓	✓	◇	◇	✗	✗	✗	✓	✗	◇	✗	✗	◇
A	BC86	✓	✓	◇	✓	✓	◇	✓	✓	◇	✗	✗	✗	✗	✓	✓	✓	✓	✓	✓	✗
A	BC89	✓	✓	✓	◇	◇	✗	✗	◇	◇	✗	✗	✗	✗	✓	✓	✓	✓	✓	✓	✗
B	A49R	✓	✓	✓	◇	◇	✗	✗	◇	◇	◇	◇	◇	◇	◇	◇	✓	◇	◇	◇	◇
B	A89, A89R	✓	✓	✓	✓	✓	◇	✓	✓	◇	✗	◇	◇	◇	◇	◇	◇	◇	◇	◇	◇
B	A119R	✓	✓	◇	✗	✗	✗	◇	✗	✗	◇	◇	◇	◇	◇	◇	◇	◇	◇	◇	◇

- ✓ = Stock Colors
- ◇ = Available Colors
- ✗ = Minimum orders of 480 for group A and 144 for group B

ROUGHNECK® SERIES FIBERGLASS HARD HATS



SUPEREIGHT® ROUGHNECK fiberglass protective caps set the standard for exceptional impact resistance, durability and crack resistance, all in the lightest weight fiberglass cap available. CSA Type 1.

Part #	Suspension	Color
P2NRW	Ratchet	Blue, Grey, Yellow, Red, Brown White, Green, Black, High Viz Orange
P2NQRW (Quick-Lok)	Ratchet	Blue, Grey, Yellow, Red, Brown White, Green, Black, High Viz Orange
P2NSW	Swingstrap	Blue, Grey, Yellow, Red White, Green
P2NQSW (Quick-Lok)	Swingstrap	Blue, Grey, Yellow, Red White, Green

SUPEREIGHT® SERIES HARD HATS



Their unique design and the performance capability of their technically advanced eight-point impact energy control system reconcile the need for protection with the need for comfort and aesthetics. ANSI Type 1

Part #	Suspension	Color
E2RW*	Ratchet	Blue, Grey, Yellow, Red, Green, White Black, Pink, Orange, Tan
E2QRW* (Quick-Lok)	Ratchet	Blue, Grey, Yellow, Red, Green, White Black, Orange, Tan
E2SW*	Swingstrap	Blue, Grey, Yellow, Red, Green, White Black, Orange
E2QSW (Quick-Lok)	Swingstrap	Blue, Grey, Yellow, Red, White Green, Black, Orange

* Blue, grey, white and green color only are class "A" stock items

CAP STYLE HARD HATS



Sensor Multi-Directional Protective Cap with impact Energy Control System and 8 Pt. Suspension. CSA Type 2.

Part #	Suspension	Color
SE2*	Ratchet	Blue, Grey, Yellow, White Red, Green, Orange
SE2QC* (Quick-Lok)	Ratchet	Blue, Grey, Yellow, Red, White, Green

* Blue, grey, white and green color only are class "A" stock items

ROUGHNECK® SERIES FIBERGLASS HIGH HEAT HARD HATS



Fiberglass Superglass protective cap, that provides Heat Protection up to 500°F. CSA Type 1.

Part #	Suspension	Color
P2HNRW	Ratchet	Blue, Yellow, White Red, Green, Orange
P2HNQRW (Quick-Lok)	Ratchet	Yellow, White

SUPEREIGHT® SERIES HARD HATS WITH FULL GRAPHIC



Full graphic design protective hats and caps raise head protection aesthetics to a new level. The full graphic process, developed and perfected by Fibre-Metal, produces complex, colorful designs that won't chip, fade or peel. ANSI Type 1.

Part #	Suspension	Color
E2RW00A389	Ratchet	With Canadian Flag graphic

BUMP CAP



Home Run Baseball Style Soft Bump Cap, Lightweight, sturdy 100% Brushed Cotton, ventilation eyelets for air circulation, protective inner shell, adjustable back strap, range of colors. Does Not Provide Protection From Falling Objects.

Part #	Color
SBC2	Black, Blue, Red, Khaki, White

FIBRE-METAL REPLACEMENT



REPLACEMENT SUSPENSIONS

Part #	Description
3RW2	Ratchet Headband (E1, E2 and P2)
3SW2	Patented Swingstrap™ (E1, E2 and P2)
3RW3	Ratchet Headband (P2N and P2HN)
3SW3	Patented Swingstrap™ (P2N and P2HN)

REPLACEMENT SWEATBAND

Part #	Description
FM44RTV	Standard Sweatband Terry Cloth Velcro closure (2/PK)



311-1101

310-1001

312-1201



312-1250

312-1252

Classic E-A-R™ Plugs

- Slow recovery PVC foam, provides comfort with low pressure
- Moisture resistant
- Noise reduction rating of 29 dB

Product no:	Description	Qty
311-1101	Corded	200 pairs/box
310-1001	Uncorded, pillow pack	200 pairs/box
312-1201	Uncorded, poly bag	200 pairs/box

EARSoft™ Yellow Neons™ and Yellow Neons Blasts™ Ear Plugs

- The softest earplugs
- Noise reduction rating of 33 dB, the highest rating available

Product no:	Description	Qty
312-1250	Regular, uncorded	200 pairs/box
312-1252	Blasts, regular, uncorded	200 pairs/box



312-1219

312-1223



318-1002

318-1003

Taperfit™ 2 Ear Plugs

- Soft and smooth for ultimate comfort
- Self-adjusting foam, provides low pressure with excellent attenuation
- Noise reduction rating of 32 dB

Product no:	Description	Qty
312-1219	Regular, uncorded	200 pairs/box
312-1223	Regular, corded	200 pairs/box

Push-Ins Ear Plugs

- Easy fit with no roll down required
- Stem allows for quick, easy and hygienic insertion and removal
- Noise reduction rating of 28 dB

Product no:	Description	Qty
318-1002	Uncorded	200 pairs/box
318-1003	Corded	200 pairs/box

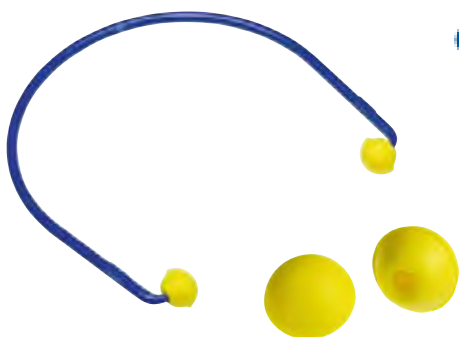

E-A-R™ Caps™ Model 200

- Comfortable, efficient and lightweight
- Noise reduction rating of 17 dB

E-A-R™ Caps™ Model 200 Replacement Pods
Product no: 321-2103 5 pairs/ box



Caboflex™ Model 600

- Conically shaped plugs, provide comfortable fit
- Noise reduction rating of 20 dB under the chin and 17 dB behind the head

Caboflex™ Model 600 Replacement Pods
Product no: 320-2004 5 pairs/ box



280050
DeciDAMP2
REFILL CONTAINER

280000
DISPENSER

280000ST
TABLE STAND
(SOLD SEPARATELY)



280020
Deci4200
REFILL CONTAINER

DISPOSABLE EAR PLUGS DISPENSER

Part #	Description
280000	Ear Plug Dispenser for DeciDamp ² and Deci4200 Ear Plugs
280050	Refill container with 500 pairs of DeciDamp ² Ear Plugs
280020	Refill container with 500 pairs of Deci4200 Ear Plugs
280000ST	Table Stand for DeciDamp/DeciDamp ² Ear Plug Dispenser



MOSQUITO

ABS head band style, light and economical.

Part #	Description	NRR
EM3144	Head Band Earmuff	21dB



MUSTANG



The best solution for the majority of tasks. Designed for comfort, good attenuation and economical.

Part #	Description	NRR
EM4155	Head Band Earmuff	23dB
EM4157	Cap Mounted Earmuff	20dB



INTRUDER

Wire head band comfort. Excellent attenuation at all frequencies, first class comfort (with a unique cup design with large flexible cup cushions).

Part #	Description	NRR
EM7202	Head Band Earmuff	28dB
EM7206	Cap Mounted Earmuff	27dB
EM7209	Cap Mounted (Fits All North Wide-Brim Hats)	27dB



PHANTOM

Bright yellow, lightweight & comfortable soft sealing cushions. Low profile, universal slot adapter, individual spring band wire, two low mounting points for even comfortable alignment, good attenuation. Padded headband on EM2262 and easy mounting arms with slot adapters for cap muff EM2266.

Part #	Description	NRR
EM2262	Head Band Earmuff	22dB
EM2266	Cap Mounted Earmuff	21dB



STEALTH

Great comfort, cushion headband and above average attenuation. Same features as Phantom.

Part #	Description	NRR
EM1282	Head Band Earmuff	25dB
EM1286	Cap Mounted Earmuff	24dB

DISPOSABLE EAR PLUGS

Made From quality materials and designed to fit most people.



Part #	Type	NRR	Bag	Qty
DeciDamp²				
280005	Uncorded	29dB	Cellophane	200/bx
282505	Uncorded	29dB	Paper	200/bx
280006	Corded	29dB	Cellophane	100/bx
280035	Corded	29dB	Paper	100/bx
Deci 4200 PU				
284200U0	Uncorded	31dB	Cellophane	200/bx
284240C0	Corded	33dB	Cellophane	100/bx
Com-Fit				
281413	Corded	26dB	Carrying case	20pr/bx

HEARING PROTECTION

Peltor

For extremely demanding noise exposures

A brand new technology of hearing protector, with dual cup shells minimizes cup resonances and provides optimum attenuation at higher frequencies and increases speech and signal intelligibility. The inside cavity and the cavity between the two shells are acoustically matched for optimum low frequency attenuation. Comfortable wide cushions filled with a soft foam material for outstanding fit and reduced contact force. An acoustically controlled super-attenuator providing effective protection and superior comfort.

	<p>Twin Cup – Headband H10A Weight 265 g Standard configuration</p> <p>NRR 29</p>		<p>H7 – Headband H7A Weight 210 g Standard configuration</p> <p>NRR 27</p>
--	---	---	--

	<p>H9 – Hard hat attachment H9P3E For use in combination with slotted hard hat. Meets the requirements in EN 352-3, size L, M and S.* Also available with adapters for other hard hat models. Options include: H9P3A Bolt-on model H9P3B Clip-on model (eg. Racal Airstream Helmet) H9P3L For Bullard CSA model helmets with foam liner H9P3E-DI Di-electric version of standard stainless steel arms Weight 180 g</p> <p>NRR 20</p>
---	--

	<p>H6 – Neckband H6B Uniquely designed for use with welding shields. Also for use with other head gear. Weight 120 g</p> <p>NRR 19</p>
---	--

You don't notice hearing loss until it's too late.



Wear hearing protection at all times!

PELTOR

3M 42 CFR 84 Particulate Respirators



8210



8511



8212



8246



8247



8576



8577



8271



8233

Features

Cool Flow* Exhalation Valve: Patented one-way valve for easy exhalation and cool, dry comfort.

M-Noseclip: Adjusts easily for fewer pressure points and greater comfort.

Faceseal: Soft and secure, conforms closely to face for long lasting comfort and protection.

Advanced Electret Media: Advanced electrostatically charged microfibers make breathing easier and cooler.

Cake-Resistant Filter Media: Specially designed filter layers provide longer respirator life and easier breathing.

Fully Adjustable Straps: A single tug helps provide comfortable, secure fit.

Description	Features							Mfg. No.
	Cool Flow Valve	M-Noseclip	Faceseal	Electret Media	Cake-Resistant Media	Carbon Filter Media	Straps	
N95, 10 ea./pk.				*			F	8210
N95, 10 ea./pk.	*	*		*			F	8511
N95, 10 ea./pk.	*		*	*	*		A	8212
R95, 20 ea./pk.				*		AG	F	8246
R95, 20 ea./pk.				*		OV	F	8247
P95, 10 ea./pk.	*	*		*		AG	F	8576
P95, 10 ea./pk.	*	*		*		OV	F	8577
P95, 10 ea./pk.	*	*	*	*			F	8271
N100, 1 ea./pk.	*		*	*			A	8233

F = Fixed
A = Adjustable

AG = Nuisance-level acid gas relief (concentrations below OSHA PEL)
OV = Nuisance-level organic vapour relief (concentrations below OSHA PEL)

FOLDABLE DISPOSABLE PARTICULATE RESPIRATOR N95

The 7230N95 & 7240N95 offer more convenience than traditional cup shaped respirators. Features include one loop elastic band (latex free) that will fit everyone without a risk of breakage. Also each respirator is individually wrapped in a plastic bag, will stay clean until the time of usage and it is easier to carry, since it will fit in your pocket. The design will offer a better face seal for a wide range of faces. The 7240N95 comes with an exhalation valve positioned to direct exhaled breath down to minimize fogging of safety glasses and maximize worker comfort and productivity.



Part #	Description
7230N95	20 per package
7240N95	10 per package

DISPOSABLE PARTICULATE RESPIRATOR P95



**NIOSH
42 CFR 84
P95**

The 8145P95 features a foam-cushion facepiece seal that conforms closely to the face for long lasting comfort and protection with adjustable straps, curved nose clip, built-in exhalation valve and charcoal layer to offer OV, AG and Ozone absorption for exposure below the PEL, nuisance level only.

Part #	Packaging
8145P95	5 per package

DISPOSABLE PARTICULATE RESPIRATOR P95



**NIOSH
42 CFR 84
P95**

Comfortable and durable, the 8140P95 features a foam-cushioned facepiece seal that conforms closely to the face for long lasting comfort and protection, latex free straps, and a built-in exhalation valve for cooler and easier breathing. The 8140P95 provides protection from any particulates, and is ideal for machining and other dusty and oily operations.

Part #	Packaging
8140P95	10 per package

DISPOSABLE PARTICULATE RESPIRATOR P100



**NIOSH
42 CFR 84
P100**

Disposable particulate respirator, type P100 with exhalation valve, adjustable strap, full flange seal cushion and curved nose clip.

Part #	Packaging
8150P100	5 per package, 10 boxes per case

DISPOSABLE PARTICULATE RESPIRATOR N95



**NIOSH
42 CFR 84
N95**

North has designed and engineered this respirator to provide exceptional comfort and worker protection. It features a soft cushioned nose seal for added comfort and a curved nose clip for improved fit. The headstraps are latex free. The 7130N95 provides protection from solids and particulate aerosols free of oil, and is ideal for dusty environments such as grinding, sanding and sweeping. The 7140N95 has the same features with benefit of a built-in exhalation valve for cooler and easier breathing.

Part #	Packaging
7130N95	20 per package
7130N95S	20 per package (Small)
7140N95	10 per package
7140N95S	10 per package (Small)

DISPOSABLE PARTICULATE RESPIRATOR N95



**NIOSH
42 CFR 84
N95**

The North 5130N95 disposable filtering facepiece provides N95 protection without breaking your budget or sacrificing comfort. Conveniently packaged 30 per box for users who may change their masks frequently during the day.

Part #	Packaging
5130N95	30 per box, 10 boxes per case



CA102



PAPR COMPACT AIR

From APR to PAPR in seconds! Compact Air for North facepiece and North Primair series head covers.

Part #	Description
CA101	Kit contains: Belt and comfort pad, blower & 9 amp. battery, charger, flow indicator, breathing tube, cover for breathing tube and a carrier
CA101D	Same as CA101 with decon belt that is washable for decontamination
CA102	Kit contains: Belt and comfort pad, blower & 7 amp. battery, charger, flow indicator, breathing tube, 1 set of covers for breathing tube and a carrier
CA102D	Same as CA102 with decon belt that is washable for decontamination

NORTH PRIMAIR™ SERIES

North Primair Series head covers are available in a variety of styles to meet your work site needs, from a lightweight facepiece to a heavy duty use.

Part #	Description	Size
PA101S, M, L	Primair Loose fitting facepiece	Small, medium or large
PA111	Primair Plus Hood	Universal
PA121	Primair Plus Hood	Universal

PRIMAIR
PA101 SERIES



PRIMAIR PLUS
PA111, PA121 SERIES



5500 SERIES HALF-MASK

NEW and IMPROVED
Cradle assembly suspension

Comfortable, lightweight non-allergenic elastomeric facepiece. Compatible with all North cartridges and filters.

Part #	Description	Packaging
550030S	Small half-mask	1 per package
550030M	Medium half-mask	1 per package
550030L	Large half-mask	1 per package



7600 SERIES SILICONE FULL FACEPIECE

Silicone full facepiece for optimal comfort and protection, equipped with a oral/nasal cup to reduce fogging. Compatible with all North cartridges.

Part #	Size	Packaging
760008AS*	Small	1 per package
760008A*	Med. / Large	1 per package

* Cartridges sold separately



7700 SERIES SILICONE HALF-MASK

NEW and IMPROVED
Cradle assembly suspension

Comfortable, lightweight silicone facepiece. Compatible with all North cartridges and filters. This is the most comfortable facepiece available.

Part #	Description	Packaging
770030S	Small half-mask	1 per package
770030M	Medium half-mask	1 per package
770030L	Large half-mask	1 per package



5400 SERIES LOW-MAINTENANCE FULL FACEPIECE

Soft, lightweight elastomeric full facepiece equipped with a oral/nasal cup to reduce fogging. Compatible with all North cartridges and filters.

Part #	Size	Packaging
54001S*	Small	1 per package
54001*	Med. / Large	1 per package

* Cartridges sold separately

GAS & VAPOR CARTRIDGES

Compatible with all North respirators and back pack adapter.



Part #	Color	Description
75SC (A)	Olive	Defender™ Multi Purpose Cartridge Organic Vapor, Chlorine, Hydrogen Chloride, Sulfur Dioxide, Hydrogen Sulfide (Escape), Hydrogen Fluoride, Chlorine Dioxide, Ammonia, Methylamine and Formaldehyde Cartridge
75SCP100 (B)	Olive	Above with P100 Particulate Filter (99.97% Minimum Filter Efficiency)
N75001 (C)	Black	Organic Vapor Cartridge
7581P100 (D)	Black	Above with P100 Particulate Filter (99.97% Minimum Filter Efficiency)
N75002 (E)	White	Chlorine, Hydrogen Chloride, Sulfur Dioxide, Hydrogen Fluoride, Formaldehyde, Chlorine Dioxide Cartridge
7582P100 (F)	White	Above with P100 Particulate Filter (99.97% Minimum Filter Efficiency)
N75003 (G)	Yellow	Organic Vapor, Chlorine, Hydrogen Chloride, Sulfur Dioxide, Hydrogen Fluoride, Chlorine Dioxide Cartridge
7583P100 (H)	Yellow	Above with P100 Particulate Filter (99.97% Minimum Filter Efficiency)
N75004 (I)	Green	Ammonia, Methylamine Cartridge
7584P100 (J)	Green	Above with P100 Particulate Filter (99.97% Minimum Filter Efficiency)
N750052 (K)*	Olive	Mercury Vapor, Chlorine Cartridge with ESLI (End-of Service-Life Indicator)
75852P100 (L)*	Olive	Above with P100 Particulate Filter (99.97% Minimum Filter Efficiency)

*Not for use with back pack adapter



PARTICULATE FILTERS



Part #	Description
75FFP100 (M)	P100 Particulate Filter "Pancake" (99.97 % Minimum Filter Efficiency)
75FFP100NL (N)	Pancake style P100 Filter with nuisance level* protection against organic vapor, acid gaz and ozone
7580P100 (O)	P100 Particulate Filter (99.97 % Minimum Filter Efficiency)
7506N95 (P)	N95 Non-Oil Particulate Filter (95% Minimum Filter Efficiency) 10/pk
7506N99 (Q)	N99 Non-Oil Particulate Filter (99% Minimum Filter Efficiency) 10/pk
7506R95 (R)	R95 Oil Particulate Filter (95% Minimum Filter Efficiency) 10/pk
7535FFP100 (S)	Adapter kit for assembly of 75FFP100 Pancake filter to a gas/vapor cartridge (except for Defender multi-purpose cartridge) include: 1 pair of N750035 adaptators (Z) and 5 pairs of 75FFP100 filters (M)
7531N95 (T)	N95 Filter Assembly, non-oil particulates. Includes (2) N750015, (2) 7506N95, (2) N750027
7531N99 (U)	N99 Filter Assembly, non-oil particulates. Includes (2) N750015, (2) 7506N99, (2) N750027
7531R95 (V)	R95 Filter Assembly, non-oil particulates. Includes (2) N750015, (2) 7506R95, (2) N750027

*Nuisance level stand for exposure not exceeding the PEL of OSHA or your local provincial regulation which ever is lower.

ACCESSORIES FOR CARTRIDGES AND FILTERS



Part #	Description
N750015 (W)	Filter Holder for 7506N95, 7506N99 and 7506R95 filters. Requires N750027 filter cover
N750027 (X)	Filter Cover for 7506N95, 7506N99 and 7506R95 filters. Attaches to Gas and Vapor cartridges. For filter use only, use N750015 Filter Holder
N750029 (Y)	Shower Cap for 7580P100 Filter. Protects filter during abatement using water or during decontamination
N750035 (Z)	Pancake adaptor for use with pancake filter and cartridge (except Defender cartridge)

GAS & VAPOR CARTRIDGES AND FILTERS FOR COMPACT AIR PAPP



Part #	Description
40HE (1)	HEPA filter (3 filters per box)
4001 (2)	Organic Vapor Cartridge (3 cartridges per box)
4003 (3)	Organic Vapor, Acid Gas Cartridge (3 cartridges per box)
4004 (4)	Ammonia / Methylamine Cartridge (3 cartridges per box)
4001HE (5)	Organic Vapor Cartridge & HEPA Filter (3 cartridges per box)
4003HE (6)	Organic Vapor, Acid Gas Cartridge & HEPA Filter (3 cartridges per box)
4004HE (7)	Ammonia / Methylamine Cartridge & HEPA Filter (3 cartridges per box)



APPB



APPA



APPC



APPD



APPE

AMBIENT AIRLINE PUMPS KITS

All inclusive kits make your selection even easier. Kits contain everything you need to set up an airline system. Includes pump, hoses, couplers, and facepiece or hood with breathing tube. For one person only.

Part #	Description
APPA	Kits include: 86610 ambient air pump, 888050H hose assembly, CF2007 breathing tube and 54001 facepiece
APPB	Kits include: 86610 ambient air pump, 888050H hose assembly and 85301T hood
APPC	Kits include: 86610 ambient air pump, 888050H hose assembly, CF2007 breathing tube and 770030M half-mask
APPD	Kits include: 86600 ambient air pump, 888050H hose assembly, CF2007 breathing tube and 54001 facepiece
APPE	Kits include: 86600 ambient air pump, 888050H hose assembly, CF2007 breathing tube and 770030M half-mask

PORTABLE FILTRATION PANEL



RFPF60C

RFPF100C

Part #	Description
RFPF60C	Portable filtration panel for breathable air, 60 cfm for 4 workers
RFPF100C	Portable filtration panel for breathable air, 100 cfm for 8 workers

New



"FRONTIER" SCBA

FRONTIER SCBA, 30 minute, 2216 psi, aluminum cylinder, nylon harness.

Part #	Description
913200MT	TPE facepiece with compact demand valve, Medium/Large size
913200SMT	TPE facepiece with compact demand valve, Small size
915200MT	PVC hood, Medium/Large size
915200SMT	PVC hood, Small size



86600

86630

AMBIENT AIR PUMPS

Choice of models: 1/4 HP, 3/4 HP, 1-1/2 HP to meet a variety of applications. Economical and easy to maintain.

Part #	Description
86600	1/4 HP ambient air pump - Can be used with a maximum of 1 facepiece and hose assembly part # 888050H
86610	3/4 HP ambient air pump - Can be used with a maximum of 2 facepiece or 1 hood and hose assembly Part # 888050H or 888100H
86630	1-1/2 HP ambient air pump - Can be used with a maximum of 3 facepiece or 2 hood and hose assembly part # 888050H & 888100H
86611	Intake filter, replacement for 86610 and 86630 ambient air pumps
86612	Exhaust filter, replacement 86600, 86610 and 86630 ambient air pumps



COMPRESSOR 1HP

Compressor for use in confined space or in other IDLH environments. Connects two workers using pressure demand respirators equipped with 5 or 10 minutes emergency egress. Warning alarm of 84db at 100 feet alerts worker of low pressure or power failure. Compressor supply up to 100 psi.

Part #	Description
86620	Compressor 1HP

Cap Lamp Models

Our modular design allows you to select the best battery, lamp head and lamp cable options for your specific requirement.



Part Number	Description and Application
GL62D11	For an 8 or 10 hour work shift, lamp head with our - 6V flange-based bulb
GL72D11	For a 12 hour work shift, lamp head with our - 6V flange-based bulb

Battery Options

At NL Technologies, we design our batteries to provide optimum performance during the work shift coupled with maximum cycle life. This translates to our customers getting the most cost effective reliable system available.



In addition, please refer to our Product Update Brochure describing how to change out your spent NiCad battery pack with a new Ni-MH pack.

The following table summarizes the battery options we can provide specific to the user's work shift:

Part Number	Discharge Capacity Up To	Recommended Work Shift
GB62D00	12 Hours	8 or 10 Hours
GB72D00	17 Hours	12 Hours

Headpiece Options

The new G11 battery pack and terminal cover will accept your existing YL Lamp cable and headpiece. In addition, you can upgrade to our new G11 headpiece on your existing YL battery pack.



Part Number	Description
GH1000	Lamp Head uses a 6V flanged bulb - Cost efficient spot

Lamp Cable Options

Our standard cable assembly is 54 inches long. It can also be purchased in a 66 inch length.



Rack Chargers

- Are available in either 20 unit or 40 unit racks
- Since the racking is modular, sections can be purchased in stages as lamp requirements grow
- The 20 unit charger can accommodate 5, 10, 15 or 20 units
- The 40 unit charger can accommodate 10, 20, 30, or 40 units
- Chargers are labeled to their corresponding internal circuitry, either standard or extended duration shifts. For example, "S" = standard, "E" = extended, "R" = radio cap lamp Ni-Cad, "RE" = radio cap lamp Ni-MH
- Charger housings are the same for Cap Lamps and Radio Cap Lamps

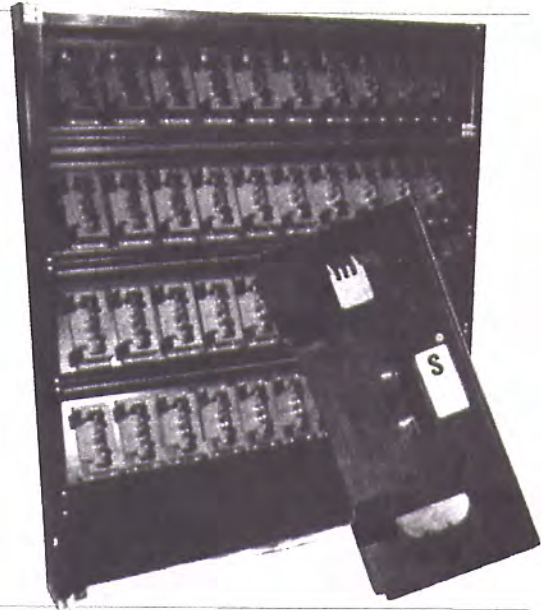

Portable Chargers

NL Technologies also offers the following portable chargers.

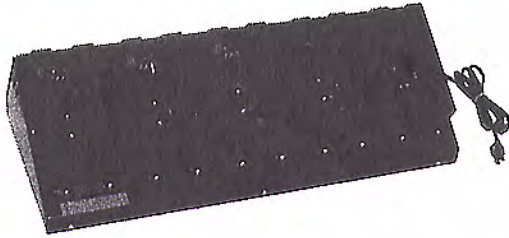

5-Unit Charger

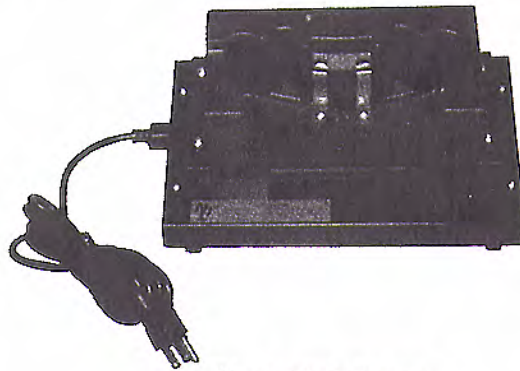

Single-Unit Charger

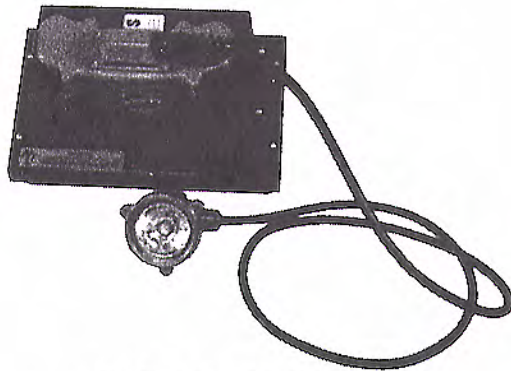

GII Cap Lamp recharging



GII Radio Cap Lamp recharging

NL Technologies is an ISO registered company.





RDN

KEEP KLEEN - Disposable Nitrile Gloves

Keep Kleen 100% nitrile gloves, deliver superior snag and puncture resistance, plus excellent flexibility and protection from a broad range of chemicals. The textured surface gives an enhanced wet/dry grip without compromising tactile sensitivity. Beaded cuff for easier donning and extra strength. Contains no natural rubber proteins that may cause

allergies. Available in 2 versions; lightly powdered and powder-free. Specifications and physical properties comply with ASTM D3578 - 95, EN455 - 1, EN455-2. Applications: parts handling, food handling, pharmaceutical, laboratories, painting and finishing.

ITEM #	DISPOSABLE GLOVES
RDV	Vinyl, Clear colour, 100 gloves per dispenser, Size S, M, L, XL
RDVB	Vinyl, Blue colour, 100 gloves per dispenser Size L, XL
RDL	Latex, 100 gloves per dispenser, Size S, M, L



**WINTER MONKEY GRIP®
Heavy Duty Cold Resistant, Vinyl Dipped**

- Maximum warmth and comfort at sub-zero temperatures
- Maintains flexibility and dexterity in cold temperatures, won't crack or stiffen
- Foam barrier blocks out cold, soft seam free liner for comfort
- STYLES: Mitts or gloves, knit wrist and safety cuff
- COLOURS: tan brown, Hi-Viz fluorescent orange
- JOB-FITTED FOR: warehouse, yard or field work, cold storage, winter transportation

TAN	ORANGE	WINTER MONKEY GRIP GLOVES	SIZES
23-191	23-491	Knitwrist, fully coated	Mens
23-393	23-499	Safety Cuff, fully coated	Mens
23-199		Knitwrist Mitt, fully coated, tan	Mens
23-299		Safety Cuff Mitt, fully coated, tan	Mens



42-325

**CRUSADER®
Medium Duty Heat Resistant, NBR Coated**

- Superior heat protection in the range 100° to 200°C (200° to 400°F)
- Dramatically better wear than cotton or leather
- Exclusive NBR coating helps protect against abrasion, cuts and snags to extend wear
- Wears an average of 4 times longer than 24 oz. cotton Hot Mill gloves
- JOB-FITTED FOR: furnace work, milling, moulding, die casting, bakeries
- OUTPERFORMS: leather, quilted cotton

ITEM #	CRUSADER GLOVES	SIZES
42-325	10" Slip-on, palm heat protection	9, 10
42-445	10" Slip-on, palm and back of hand heat protection, reinforced thumb crotch	9, 10
42-474	Same As #42-445, 14" gauntlet	9, 10



27-602

**HYCRON®
Heavy-Duty, Puncture-Resistant Nitrile Dipped**

- Tough nitrile coating
- Economical replacement for leather gloves – outwears leather 2 to 1
- Excellent protection against cuts punctures, abrasion
- Superior flexibility and grip
- Curved fingers for natural fit
- JOB-FITTED FOR: handling building materials, green logs and lumber, shearing, punch press, draw press operations, handling castings, cores and fabricated metal

ITEM #	HYCRON GLOVES	SIZES
27-600	Knitwrist, palm coated	8, 10
27-602	Knitwrist, fully coated	8, 10
27-607	Safety Cuff, palm coated	8, 10
27-805	Safety Cuff, fully coated	10



SUPPORTED NATURAL RUBBER GLOVES

Yellow wrinkle finish - Gauntlet is liquid proof;
handles dry, wet and slippery objects with ease.



T66FWG



T63FWG



T65FWG

Part #	Description
--------	-------------

T63FWG*	Grip-Task - Natural rubber gloves - supported knit wrist palm coated - Sizes: 11XXL (Men), 8XL (Ladies)
---------	---

T66FWG*	Grip-Task - Natural rubber gloves - supported safety cuff palm coated - Sizes: 11XXL (Men), 8XL (Ladies)
---------	--

T65FWG*	Grip-Task - Natural rubber gloves - supported gauntlet 12 in (30 cm) - Size: 11XXL
---------	--

* Caution: These products contain natural rubber latex which may cause an allergic reaction in some individuals



100% Latex Flock Line

100% UNSUPPORTED NATURAL RUBBER (LATEX) GLOVES

Provides excellent dexterity
Length 12 in (30 cm).

Part #	Description
--------	-------------

T254FL*	100% natural rubber (latex) flock line - blue - 18 mil (0.45 mm) flocked - honey comb pattern - Sizes: 7S, 8M, 9L, 10XL
---------	---

T297FL*	100% natural rubber (latex) flock line - yellow - 18 mil (0.45 mm) flocked - honey comb pattern - Sizes: 7S, 8M, 9L, 10XL
---------	---

T950FL*	Heavy weight 100% natural rubber (latex) flock line Black - 25 mil (0.65 mm) - flocked - honey comb pattern Sizes: 7S, 8M, 9L, 10XL
---------	---

* Caution: These products contain natural rubber latex which may cause an allergic reaction in some individuals



Rubber Gloves

UNSUPPORTED HEAVY NATURAL RUBBER (LATEX) GLOVES

Part #	Description
--------	-------------

Ri504*	Rubber gloves - black natural rubber - 52 mil (1.30 mm) 17 in (43 cm) - Sizes: 9L, 10XL, 11XXL
--------	--

* Caution: These products contain natural rubber latex which may cause an allergic reaction in some individuals



RightTask

SUPPORTED VINYL GLOVES



Part #	Description
--------	-------------

T961	RightTask - Vinyl coated knit glove - knit wrist - yellow Sizes: 7S, 8M, 9L
------	---

T114	FlexTask - Vinyl impregnated on a cotton glove - Slip-on Inseam - Yellow - Sizes: 7S, 8M, 9L, 10XL
------	--



UNSUPPORTED NITRILE GLOVES

Outperforms natural rubber, neoprene and vinyl gloves when exposed to solvents, caustics and animal fats.



Part #	Description
--------	-------------

LA102G	Nitri-Guard - Nitrile gloves - green - 11 mil (0.28 mm) 13 in (33cm) - unflocked - Sizes: 7S, 8M, 9L, 10XL, 11XXL
--------	---

LA132G	Nitri-Guard - Nitrile gloves - green - 15 mil (0.38 mm) 13 in (33cm) - flocked - Sizes: 7S, 8M, 9L, 10XL, 11XXL
--------	---

LA172G	Nitri-Guard - Nitrile gloves - green - 17 mil (0.43 mm) 13 in (33 cm) - flocked - Sizes: 7S, 8M, 9L, 10XL, 11XXL
--------	--

LA258G	Nitri-Guard - Nitrile gloves - green - 25 mil (0.63 mm) 18 in (45.7cm) - unflocked - Sizes: 7S, 8M, 9L, 10XL, 11XXL
--------	---

BLUE TUFF

SUPPORTED HEAVY NITRILE GLOVES

Abrasion and cut resistant.
Provide excellent grip and longer life.



Part #	Description
--------	-------------

T202	BlueTuff - Heavy nitrile coated glove over jersey liner knit wrist - fully coated - blue - premium quality Sizes: 8M, 9L, 10XL
------	--

T257	BlueTuff - Heavy nitrile coated glove over jersey liner - band top - fully coated - blue Sizes: 9L, 10XL
------	--

T102	BlueSafe - Nitrile coated glove over jersey liner knit wrist - fully coated - blue - Sizes: 8M, 9L, 10XL
------	--

T157	BlueSafe - Nitrile coated glove over jersey liner safety cuff - fully coated - blue - Sizes: 9L, 10XL
------	---



NFD15

NFD16



NF13

NFF13C



NF14

NFK14



NF15

NF17C



NF35

LightTask PLUS

SUPPORTED POLYURETHANE OVER DYNEEMA® YARN SEAMLESS LINER

Part # Description

NFD15 Light Task Plus II - Dyneema® yarn, seamless liner coated with white polyurethane - Knit wrist - cut resistance level 2 - Sizes: 7S, 8M, 9L, 10XL, 11XXL

NFD16 Light Task Plus III - Dyneema® yarn, seamless liner coated with white polyurethane - Knit wrist - cut resistance level 3 - Sizes: 7S, 8M, 9L, 10XL, 11XXL

NITRiTASK NITRILE OVER SEAMLESS LINER

Part # Description

NF13 NitrTask - White nylon seamless liner with a grey nitrile coating - knit wrist - Sizes: 7S, 8M, 9L, 10XL, 11XXL

NFF13 NitrTask Foam - White nylon seamless liner with grey foam nitrile coating - knit wrist - Sizes: 7S, 8M, 9L, 10XL, 11XXL

NFKL13 NitrTask KL - Kevlar®/Lycra® seamless liner with a black nitrile coating - knit wrist - Sizes: 7S, 8M, 9L, 10XL, 11XXL

NFK13 NitrTask Plus - Kevlar® seamless liner with a grey nitrile coating - knit wrist - Sizes: 7S, 8M, 9L, 10XL, 11XXL

NFF13C Nitr Task C5 - Aramid/steel/polyester seamless liner with blue sponge nitrile coating - knit wrist - Sizes: 7S, 8M, 9L, 10XL

DuroTask

NATURAL RUBBER OVER SEAMLESS LINER

Part # Description

NF14 DuroTask - Cotton and polyester seamless liner coated with a blue natural rubber (latex) - knit wrist - Sizes: 7S, 8M, 9L, 10XL, 11XXL

NF14HD DuroTask Sub Zero - Acrylic/cotton seamless liner coated with a black natural rubber (latex) - Knit wrist - Sizes: 7S, 8M, 9L, 10XL, 11XXL

NFK14 DuroTask Plus - Kevlar® seamless liner coated with a blue natural rubber (latex) - Knit wrist - Sizes: 7S, 8M, 9L, 10XL, 11XXL

LightTask

POLYURETHANE OVER SEAMLESS LINER

Part # Description

NF15 LightTask - Nylon seamless liner coated with a white polyurethane - Knit wrist - Sizes: 7S, 8M, 9L, 10XL, 11XXL

NF17C LightTask C4 - Fibre glass seamless liner coated with black PU - Cut resistant level 4 - Sizes: 7S, 8M, 9L, 10XL, 11XXL

OilGrip NITRILE OVER SEAMLESS LINER

Part # Description

NF35 OilGrip - Dark green nylon seamless liner coated with black nitrile & MicroFinish® - Sizes: 7S, 8M, 9L, 10XL, 11XXL

Dyneema® is a registered trademark of Royal DSM N.V.
Kevlar® is a registered trademarks of E.I. DuPont de Nemours and Company.
MicroFinish® is a registered trademark of the Towa Corporation.

SUPERLITE PLUS

SUPPORTED NITRILE GLOVES

Knit wrist - Yellow - Launderable for additional wear and value.



T4700



T4700P

Part #	Description
T4700	SuperLite Plus - Light nitrile coated glove over Interlock liner - fully coated Sizes: 6XS, 7S, 8M, 9L, 10XL, 11XXL
T4700P	SuperLite Plus - Light nitrile coated glove over Interlock liner - palm coated Sizes: 6XS, 7S, 8M, 9L, 10XL, 11XXL



TRAWLER KING PVC COATED GLOVES

Resistant to some acids and caustics.



Part #	Description
840FWG	Trawler King - PVC coated glove over a jersey liner gauntlet - 12 in (30cm) - green - double dip Sizes: 8M, 9L, 10XL
850FWG	Trawler King - PVC coated glove over a jersey liner gauntlet - 14 in (35.5cm) - green - double dip Sizes: 8M, 9L, 10XL
870FWG	Trawler King - PVC coated glove over a jersey liner gauntlet - 18 in (45cm) - green - double dip Sizes: 10XL
T1412WG	DeckHand - PVC coated glove over a seamless liner - Gauntlet - 12 in (30cm) - Curved hand fit made for the fishing industry - orange Sizes: 8M, 9L, 10XL, 11XXL
T1612WG	ProChem - PVC coated glove over a seamless liner Gauntlet - 12 in (30cm) - Curved hand fit made for the petrochem industry - blue Sizes: 8M, 9L, 10XL, 11XXL
1214FWG	Master Miner - PVC coated glove over jersey liner Gauntlet with flare cuff 14 in (35.5cm) - green Size: 10XL



EcoKNIT PLUS WHITE KNIT GLOVES

Part #	Description
11RK	EcoKnit - White knit glove - 80% polyester/ 20% cotton - Ambidextrous - Knit wrist Sizes: 7S, 8M, 9L, 10XL
12RK	EcoKnit Plus - White knit glove - 70% nylon/ 30% polyester - Ambidextrous - Knit wrist Sizes: 7S, 8M, 9L, 10XL



Winter Spit Fire SUPPORTED PVC GLOVES



Double dip - Rough sandy finish - Will not stiffen or crack in oil or cold salt water.

Part #	Description
3501FWG	Winter Spitfire - PVC coated glove - Foam liner gauntlet - 10 in (25 cm) - HiViz orange - Size: 10XL
3514FWG	Winter Spitfire - PVC coated glove - Foam liner gauntlet - 14 in (35.5 cm) - HiViz orange - Size: 10XL
3500KW	Winter Task - PVC coated glove - laminated foam liner knit wrist - fully coated - HiViz orange Size: 10XL
3502BT	Winter Task (O) - PVC coated glove - laminated foam liner band top cuff - HiViz orange - Size: 10XL
1502BT	Winter Task (B) - PVC coated glove - laminated foam liner band top cuff - brown - Size: 10XL
1802BT	Winter Task (G) - PVC coated glove - laminated foam liner band top cuff - green - Size: 10XL



ROUGH TUFF Dots Coated Knit Gloves



Part #	Description
K311	Dots-Grip - String knit poly-cotton 65%/35% glove black PVC dots on both sides - Ambidextrous Knit wrist - Sizes: 10XL (Men) 7L (Ladies)
K211	Dots-Grip - String knit poly-cotton 65%/35% glove black PVC dots on one side only - Ambidextrous Knit wrist - Sizes: 10XL (Men) 7L (Ladies)
T431	Rough Tuff - Seamless cotton blend knit glove natural rubber (latex) laminated palm Size: 8M, 9L, 10XL



DEXI-TASK

Highly resistant and puncture resistant. Excellent sensitivity, dexterity and extreme comfort. Protects against wide range of chemicals. Packaged 100 gloves per box.

Part #	Description
LA049	Dexi-Task - AQL 1.5 - Nitrile powdered textured examination gloves - blue - Sizes: S, M, L, XL
LA049PF	Dexi-Task - AQL 1.5 - Nitrile powder free textured examination gloves - blue - Sizes: S, M, L, XL
LA049IND	Dexi-Task - AQL 4.0 - Nitrile powdered textured industrial gloves - blue - Sizes: S, M, L, XL
LA049PFIND	Dexi-Task - AQL 4.0 - Nitrile powder free textured industrial gloves - blue - Sizes: S, M, L, XL



VINY-TASK

Excellent sensitivity and dexterity. Protects against product or personal contamination. Packaged 100 gloves per box.

Part #	Description
T525	Viny-Task - Vinyl powdered textured gloves Sizes: S, M, L, XL
T525PF	Viny-Task - Vinyl powder free textured gloves Sizes: S, M, L, XL



SENSI-TASK

Superior sensitivity, excellent dexterity. Protects against contamination. Strong, non-sterile. Packaged 100 gloves per box.

Part #	Description
T425*	Sensi-Task - AQL 4.0 - Natural rubber (latex) powdered textured gloves - Sizes: S, M, L, XL
T425PF*	Sensi-Task - AQL 4.0 - Natural rubber (latex) powder free textured gloves - Sizes: S, M, L, XL

* Caution: These products contain natural rubber latex which may cause an allergic reaction in some individuals



Mecano TASK

Provides more puncture resistance than rubber or vinyl gloves. Packaged 50 gloves per box.

Part #	Description
LA0812	Mecano-Task - AQL 4.0 - 8 mil (0.20 mm) Blue nitrile powdered gloves diamond embossed grip - Sizes: S, M, L, XL



Plus Neoprene

UNSUPPORTED NEOPRENE GLOVES

Acid resistant, Provides good chemical protection, tear and puncture resistance.

Part #	Description
T224FLC*	Neoprene over natural rubber (latex) flock line - blue over yellow - 28 mil (0.70mm) - flocked - honey comb pattern 12 in (30cm) - Sizes: 7S, 8M, 9L, 10XL
T1119FLC	Neoprene Plus - Neoprene gloves black 30 mil (0.75 mm) - flocked - honey comb pattern 12 in (30cm) - Sizes: 7S, 8M, 9L, 10XL, 11XXL

* Caution: These products contain natural rubber latex which may cause an allergic reaction in some individuals

Mecano GLOVE



M3000



M2900



M2800

Part #	Description
M3000	Expert - Deer skin grain palm with a reinforced patch on palm & fingers - knuckle protective bands & finger tips with a black Spandex back Sizes: 7S, 8M, 9L, 10XL
M2900	Senior-Pro - Black & gray Clarino® palm with reinforced patches on palm & fingers with a blue Spandex back - Sizes: 7S, 8M, 9L, 10XL
M2900LC	Winter Senior-Pro - Same as M2900 with Thinsulate® - Sizes: 8M, 9L, 10XL
M2800	Junior-Pro - Black Clarino® palm with a black Spandex back - Sizes: 7S, 8M, 9L, 10XL

Ropers & Drivers



ALL GRAIN COWHIDE
LEATHER GLOVES

Part #	Description
148Ri	Roper's glove with snap - all grain cowhide leather unlined - Sizes: 7S, 8M, 9L, 10XL
148LRi	Same as 148Ri - fully lined - Sizes: 7S, 8M, 9L, 10XL
248Di	Driver's glove - all grain cowhide leather gunn cut style - unlined - Sizes: 7S, 8M, 9L, 10XL
248LDi	Same as 248Di - fully lined - Sizes: 7S, 8M, 9L, 10XL



Welder's
GLOVE



Part #	Description
1590Gi	Fully lined welders glove - one piece back grey - Size: 10XL (Men)
1590BLAW	Fully lined welders glove - one piece back blue leather - wing thumb - grey leather palm Kevlar® thread - Size: 10XL (Men)
752	T.I.G. welders glove - split deer skin and split leather cuff with gore - Sizes: 8M, 9L, 10XL, 11XXL
786	T.I.G. welders glove - very soft grain sheep skin leather - strap at thumb split leather cuff - Sizes: 8M, 9L, 10XL, 11XXL



CLUTE
Glove

SPLIT LEATHER
PALM GLOVES
WITH COTTON BACK

Part #	Description
137Ki	Men's split leather palm glove - cotton back knit wrist - Sizes: 10XL (Men)
137FKi	Men's split leather palm & index glove cotton back - knit wrist - Sizes: 10XL (Men)
L137FKi	Same as 137FKi - Sizes: 8XL (Ladies)



HEAT RESISTANT
GLOVES & MITTS

Up to 2000°F

Length 14" (35.5 cm) (except cover mitt)
Size: 11XXL.

Part #	Description
ZP2814M	ZetexPlus® mitt with a melton lining - regular 14 in (35.5 cm) length - Size: 11XXL (Men)
KV2814M	Kevlar® mitt with a melton lining - regular 14 in (35.5 cm) length - Size: 11XXL (Men)
RKV2814M	Kevlar® mitt with a melton lining - Ambidextrous regular - 14 in (35.5 cm) length - Size: 11XXL (Men)
KV2914M	Kevlar® single palm glove with a melton lining 14 in (35.5 cm) length - Size: 11XXL (Men)
ZP2810	ZetexPlus® cover mitt with a straight thumb Size: 11XXL (Men)
KV2810	Kevlar® cover mitt with a straight thumb Size: 11XXL (Men)

Clarino® is a registered trademark of Kurary Co., Ltd.
Thinsulate® is a registered trademark of the 3M Company.
Kevlar® is a registered trademarks of E.I. DuPont de Nemours and Company.
ZetexPlus® is a registered trademarks of Newtux Industries Inc.



DPX3370RBi



2370LPBi



2770LPEi



3370LPRBi

Split Fitters GLOVE

GRAY SPLIT LEATHER FITTERS GLOVES

Part #	Description
2770LPEi	Grey split leather fitters glove - patch palm "C/D" grade - cotton lined palm - 2 in (5.1 cm) starched cuff - Sizes: 10XL (Men)
2370LPBi	Men's grey split leather fitters glove - "C" grade cotton lined palm - 2 in (5.1 cm) plastified cuff Sizes: 10XL (Men)
L2370LPBi	Same as 2370LPBi - Sizes: 8XL (Ladies)
2370RGi	Grey split leather fitters glove - "C" grade cotton lined palm - 5 in (12.7 cm) rubberized cuff - Sizes: 10XL (Men)
DPX3370RBi	Grey split leather fitters glove - "B" grade blue split leather double palm and index cotton lined palm - 2 in (5.1 cm) rubberized cuff - Sizes: 10XL (Men)



Fitters GLOVE

GRAIN COWHIDE LEATHER FITTERS GLOVES



Part #	Description
2870LPBi	Grain cowhide leather fitters glove - patch palm - "C/D" grade cotton lined palm - 2 in (5.1 cm) - plastified cuff Sizes: 10XL (Men)
L2870LPBi	Same as 2870LPBi - Sizes: 8XL (Ladies)
2470Bi	Grain cowhide leather fitters glove - "C" grade - unlined 2 in (5.1 cm) plastified cuff - Sizes: 7S, 8M, 9L, 10XL
2470LPBi	Grain cowhide leather fitters glove - "C" grade - cotton lined palm - 2 in (5.1 cm) - plastified cuff - Sizes: 10XL (Men)
L2470LPBi	Same as 2470LPBi - Sizes: 8XL (Ladies)
2470RGi	Grain cowhide leather fitters glove - "C" grade - fully lined 5 in (12.7 cm) - rubberized cuff - Sizes: 10XL (Men)



Winter Split Fitters GLOVE

GRAIN COWHIDE LEATHER FITTERS GLOVES FULLY LINED



Part #	Description
3470LCRBi	Grain cowhide leather fitters glove - "B" grade - heavy foam and fleece lining - 2 in (5.1 cm) - rubberized cuff Sizes: 11XXL (Men)
L3470LCRBi	Same as 3470LCRBi - Sizes: 8XL (Ladies)
4470LCRBi	Grain cowhide leather fitters glove - "B" grade - heavy pile lining 2 in (5.1 cm) - rubberized cuff - Sizes: 11XXL (Men)
5470TRBi	Grain cowhide leather fitters glove - "B" grade lined with Thinsulate® - 2 in (5.1 cm) - rubberized cuff Sizes: 11XXL (Men)



Winter Split Fitters GLOVE

GRAY SPLIT LEATHER FITTERS GLOVES FULLY LINED

Part #	Description
3370LCRBi	Grey split leather fitters glove - "B" grade - heavy foam and fleece lining - 2 in (5.1 cm) - rubberized cuff Sizes: 11XXL (Men)
4370LCRBi	Rust split leather fitters glove - "B" grade heavy pile lining - 2 in (5.1 cm) - rubberized cuff Sizes: 11XXL (Men)
L4370LCRBi	Same as 4370LCRBi Sizes: 8XL (Ladies)
5370TRBi	Grey split leather fitters glove - "B" grade lined with Thinsulate® - 2 in (5.1 cm) - rubberized cuff Sizes: 11XXL (Men)
70/6465NK	North Polar® - Blue split cowhide glove - wing thumb safety cuff with integrated - knit wrist - Thinsulate® water proof liner - Sizes: 8XL (Ladies) 11XXL (Men)



ALL-TASK LEATHER WORK GLOVES

Part #	Description
1348BSi	All-Task - Glove with a grain cowhide leather - palm and split leather back - 2 in (5.1 cm) - band top cuff - Size: 10XL (Men)
1348GSi	All-Task - Glove with a grain cowhide leather palm and split leather back - 4 in (10.2 cm) - gauntlet cuff - Size: 10XL (Men)

Thinsulate® is a registered trademark of the 3M Company.

Deluxe LINEMAN GLOVES

Deluxe Lineman Gloves

These deluxe lineman gloves are made with select heavyweight 3 1/2 oz grain horsehide leather, that has been treated with a fluoro-chemical water-repellent emulsion for excellent water, oil, and stain-repellent properties. (The soft, breathable qualities of the leather are not affected by this water-repellent treatment.) Other special features include our performance thumb/palm patch, which reinforces critical-wear areas with a double layer of leather. The back of the cuff is made with a fluorescent-yellow leather with a contrasting red stripe for daytime visibility and a 3M Scotchlite™ retro-reflective strip for night-time visibility. All styles are sewn with Kevlar® thread for extra seam strength.

- 365DLX2 Deluxe lineman glove, 2" safety cuff
Sizes: S - XL
- 365DLX6 Deluxe lineman glove, 6" gauntlet
Sizes: S - XL
- 365DLXFTL Deluxe lineman glove, 6" gauntlet, hand is fully C100 Thinsulate® lined
Sizes: M - XL
- 365DLX2TL Deluxe lineman glove, 2" safety cuff, hand is fully C100 Thinsulate® lined
Sizes: M - XL



365DLX2



365DLX6



Engineered hand protection for every industry™

Deluxe LINEMAN MITTS

Deluxe Lineman Mitts

These deluxe lineman mitts are made with select heavyweight 3 1/2 oz grain horsehide leather, that has been treated with a fluoro-chemical water-repellent emulsion for excellent water, oil, and stain-repellent properties. (The soft, breathable qualities of the leather are not affected by this water-repellent treatment.) Other special features include our performance thumb/palm patch, which reinforces critical-wear areas with a double layer of leather. The back of the cuff is made with a fluorescent-yellow leather with a contrasting red stripe for daytime visibility and a 3M Scotchlite™ retro-reflective strip for night-time visibility. All styles are sewn with Kevlar® thread for extra seam strength.

- 361DLX6 One-finger Deluxe lineman mitt, 6" gauntlet
Sizes: S - XL
- 361DLXFTL One-finger Deluxe lineman mitt, 6" gauntlet, hand is fully C100 Thinsulate® lined
Sizes: M - XL
- 361DLXWL One-finger Deluxe lineman mitt, 6" gauntlet, complete with a removable wool liner
Sizes: S - XL



Gloves vs. Mitts

Which are warmer? This is an age old debate. All things being equal, mitts are warmer. That's because with mitts the fingers are not isolated in small areas and the air around the fingers acts as insulation against the cold. Interestingly, the same is true in reverse. If you want heat protection, mitts are better for the same reason. The air around the fingers insulate

Protective Clothing for Chainsaw Operators

NORTH is proud to offer to the forestry workers' industry a complete range of leg protective garments (Aprons, leggings and pants)

These safety products complement our line of protective devices for forestry workers such as **TASKALL** forestry gloves, the **NORTH** forestry kits, the **NORTH** visor and the **NORTH** hearing protectors

CHAINSAW OPERATOR PROTECTIVE PANTS

Model 863C

Chainsaw pants
Outside material 100% nylon, 200 deniers
Regular seat
Safety pads 69 cm (27") long in front only
Color: Forest Green
Sizes: 32 to 56

Model 736BNQ

Chainsaw pants polyester cotton with nylon pads sewn in front and sides for additional protection. Meet or exceeds BNQ standards
Color: Forest Green
Elastic back for two size fit
Sizes: 28 - 30
32 - 34
36 - 38
40 - 42
44 - 46

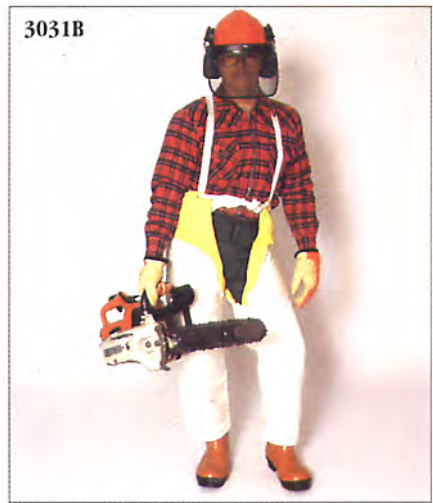

APRONS AND LEGGINGS FOR CHAINSAW OPERATORS

Model 3031B

Protective aprons for chainsaw operators
Outside material 100% nylon, 200 deniers
Safety pads 43 cm (17") long in front
Total length 69 cm (27")
Color: yellow
One size fits all
Belt not included



Models: 1031B28 1031B32

Protective legging for chainsaw operators
Outside material 100% nylon, 200 deniers
Safety pads 56 cm or 71 cm (22" or 28") front only
Adjustable strap
Total length:
1031B28: 71 cm (28")
1031B32: 81 cm (32")
One size fits all
Belt not included



Model 2031B

Specialized protective pants for chainsaw operators
Outside material P. V. C. on nylon and ballistic nylon
Safety pads front and back 91 cm (36") long
Total length 107 cm (42")
One size fits all
Color: yellow and white

NORTH

WELDER'S CLOTHINGS



LSLCAPE shown with AFRCPT6 Bib



LSLCAPE Back View



LCAPE12



LCAPE12 Back



LCAPE12 shown with ALCAPE25 Bib



Leather and Proban® Cape Sleeves

TOP STAR cape sleeves offer versatile protection for welders. The open backs mean cool comfort and lighter weight. Depending on the welding application, snap on an additional bib. If the bib portion wears out, it is easily replaced. Features include: Loop on collar, riveted stress points, soapstone pocket on sleeves, Kevlar

sewing throughout, plus 3 position adjustable collar and wrist snaps.

Proban® is a registered trademark of Albright & Wilson Ltd.



ITEM #	WELDER'S CAPE SLEEVES
LCAPE12	TOP STAR, all leather, sizes S (36-38), M (38-40), L (40-42), XL (42-44)
LSLCAPE	TOP STAR, flame retardant Proban® front and back, all leather sleeves, sizes S (36-38), M (38-40), L (40-42), XL (42-44)
PFRCAPE	All Proban® flame retardant cotton cape sleeve, size S, M, L, XL
ALCAPE16	16" snap on leather bib. Fits all SUPERIOR cape sleeves
ALCAPE25	25" snap on leather bib. Fits all SUPERIOR cape sleeves
AFRCPT6	16" Proban® flame retardant cotton bib. Fits all SUPERIOR cape sleeves



CP3.75

Leather Cable Covers

Leather cable covers protect MIG and TIG welding and plasma cutting

cable from stray sparks and welding splatter. Available in 25' rolls.



ITEM #	LEATHER CABLE COVERS
CP3.75	3.75" width, 25' long roll, cable protector
CP6.5	6.5" width, 25' long roll, cable protector

Work clothing

NORTH offers you a complete line of work clothes including shirts, pants, coveralls and shop coats for summer or winter use. Manufactured in Canada, by skilled personnel. Materials are of first quality from well known suppliers and warranted against manufacturer's defects.

IMPORTANT: We carry a complete stock of all sizes in navy blue in order to offer the best possible service to our customers. Other colors are manufactured upon request

NORTH offers various choices of material, ranging from 100% cotton to a 65/35% polyester/cotton blend as well as a complete range of sizes, from 23 to 56, in regular, tall or short as per your needs. A choice of colors is also available with certain styles.

A-820



INSULATED COVERALL

Model A-820
Insulated coverall P. P. Drill
Color: Navy Blue
65% polyester / 35% cotton
Liner: 100% polyester
Zipper closure
Sizes: S, M, L, XL, XXL, XXXL

Model A-820/0
Same as A-820
Color: Orange

P175C



COVERALLS
Model P174C
Service Drill coverall
65% polyester
35% cotton
Color: Navy Blue
Snap closures
Sizes: 34 to 56

Model P175C
Service Drill coverall
65% polyester
35% cotton
Color: Navy Blue
Zipper closure
Sizes: 34 to 56

Model P175/0
Same as P175C
Color: Orange

Model P178C
Super Twill Coverall
100% cotton
Color: Navy Blue
Zipper closure
Sizes: 34 to 56

Model P179C
Super Twill Coverall
100% cotton
Color: Navy Blue
Snap closures
Sizes: 34 to 56

1298

1296

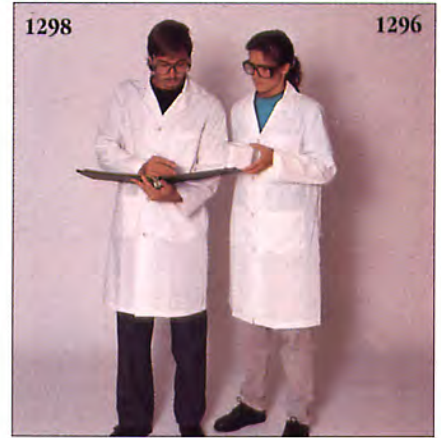

LAB COATS

Model 1296
Ladies' lab coat
Super Twill white
65% polyester / 35% cotton
Snap closures
Sizes: S, M, L, XL

Model 1298
Men's lab coat
Super Twill white
65% polyester / 35% cotton
Snap closures
Sizes: S, M, L, XL

P181C



SHOP COATS

Model P181C
Men's Service Drill shop coat
65% polyester / 35% cotton
Snap closures
Color: Navy Blue
3 pockets (one breast and 2 side pockets)
Sizes: S, M, L, XL, XXL, XXXL

NOTE: All coveralls come with 2 breast pockets (1 with flap; 1 with pencil slot), 2 back pockets, 2 side pass through pockets, 1 tool loop. We also manufacture coveralls with optional reflective tape. Please ask order desk personnel for more details.

150C



SHIRTS
Model 150C
P. P. Drill work shirt
Color: Navy Blue
50% polyester
50% cotton
Sizes: 14 to 20

PANTS
Model P160C
P. P. Drill work pants
Colors: Navy Blue
50% polyester
50% cotton
Sizes: 34 to 56

P160C

NORTH

DISPOSABLE CLOTHING



Available in Small (S) to 3XL*.

Part #	Description
85596	Vented disposable coverall, white color with resealable flap, 2 way zip, elastic waist and knitted cuff
25596	Flame retardant disposable coverall, green color, NFPA701, with resealable flap, 2 way zip, elastic waist and cuff
35596	Disposable coverall, blue color with resealable flap, 2 way zip, elastic waist and knitted cuff

TYCHEM® SL SERIES

Bound seams coverall made with a multi-layered material. Available in Small (S) to 3XL*.



Part #	Description
45595	Coverall with a front zipper & storm flap, attached hood elastic face opening, wrists & ankles

TYVEK® SERIES

Serged seams Tyvek® coverall. Available in Small (S) to 3XL*.



Part #	Description
55595	Coverall with a front zipper, attached hood, elastic face opening, wrists & ankles

RAINWEAR



2" Yellow North-Brite™ Retro-Reflective Material on Bright Orange Heavy Duty PVC. Meets CSA Class 2, Level 2, Table 2B when worn separately and meets CSA Class 3 When TV7001HV and TV7002HV are worn together. Available in Medium (M) to 3XL*.

Part #	Description
TV7001HV	Jacket - 2 vertical stripes on front, 360° horizontal stripe around torso, stripe around the arms & "X" on back
TV7002HV	Bib pant - Stripe around legs
AV7004HV	Hood with draw string

These suits are made of PVC and all seams are electronically sealed. Both types of suits are available as complete sets (jacket, bib pants, hood). Available in Medium (M) to 4XL*.



Part #	Description
85JPH	"FR Rain Gear" 35 mil flame retardant PVC on polyester

This new high performance rain gear is made of a heavy duty PVC on nylon, which is flame resistant, water repellent, abrasion resistant and has good chemical hold out. Sizing is generous, hardware used in it's construction is rust proof. Seams are sealed. Available in Medium (M) to 3XL*.



Part #	Description
A4016Y	Jacket 30" - Flame retardant PVC on nylon Available in orange, yellow or light green color
A4015Y	Bib pant - Flame retardant PVC on nylon Available in orange, yellow or light green color

CAPE ISLANDER FOUL WEATHER GEAR



A3016

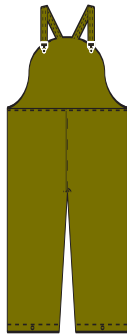

A3015LG

Cape Islander is the ultimate in full weather gear, especially engineered for the North American Fisherman. The North Cape Islander is of the highest quality. Super resistant as well as extremely comfortable. This suit is made of a thick PVC coating on a strong fabric made of a blend of 65% polyester and 35% cotton (polyester offering strength, cotton offering that smooth feeling as well as serving as an absorbant). The special PVC coating offers the best resistance to fish oil and salt water. It also maintains its flexibility when used in very cold weather. Electronically sealed and sewn, seams offer the best tear resistance. In addition, we have also made this suit fire retardant.

Features / Benefits

- Made of PVC coating on 65% polyester and 35% cotton fabric
- Flame retardant, resistance to fish oil, salt water and most chemicals
- All seams are electronically sealed
- Available in size small to 3XL
- Available in 3 colors; hi-viz orange, lime green and yellow

Jacket

Part #	Description	Sizes
A3016	Cape Islander hooded jacket, 30" (76 cm) long, flame retardant, Hi-Viz orange color	S to 3XL
A3016LG	Cape Islander hooded jacket, 30" (76 cm) long, flame retardant, light green color	S to 3XL
A3016Y	Cape Islander hooded jacket, 30" (76 cm) long, flame retardant, yellow color	S to 3XL



A3005Y



Bib Pants

Part #	Description	Sizes
A3015	Cape Islander bib pants with removable elasticized suspenders, flame retardant, Hi-Viz orange color	S to 3XL
A3015LG	Cape Islander bib pants with removable elasticized suspenders, flame retardant, light green color	S to 3XL
A3015Y	Cape Islander bib pants with removable elasticized suspenders, flame retardant, yellow color	S to 3XL

Long Coat

Part #	Description	Sizes
A3005Y	Cape Islander long coat, 48" (122 cm) flame retardant, yellow color	S to 3XL

ACID-PRO SUITS



AC1001

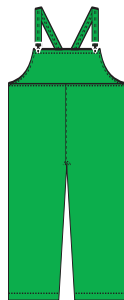

AC1002

The Acid-Pro flame retardant suit offers good body protection against chemical splash, made of 35 mil PVC on nylon with all seams double stitched and sealed. The front zipper closure is well protected by a storm flap with a snap button. The sleeves and legs include a double piece with elastic at the bottom preventing liquids from penetrating inside.

Features / Benefits

- Flame retardant.
- Economical, made of 35 mil PVC on nylon.
- Color is lime green for easy identification.
- Could double as a rainsuit if required.
- All seams double stitched and sealed

Part #	Description	Sizes
AC1001	Hooded jacket, flame retardant, 30" (76 cm) long	S to 3XL
AC1002	Bib pants with suspenders, flame retardant	S to 3XL



MODEL 1345
ZIPPER AT LEG

COVERALL

65% polyester/ 35% cotton, 2 front chest pockets, 1 with pencil slot, 1 with flap, 2 front swing pockets, side opening to trouser, 2 rear hip pockets, ruler pocket, concealed nylon zipper, reinforced at all points of strain.

Model: 1443

Colour: Orange

Model: 1445

Colours: Navy, Green, Grey, Brown, Postman-Blue, Royal-Blue
Black, Charcoal

Model: 1445W

Colour: White

Model: 1445X (promotion)

Colour: Navy

Model: S45 (promotion)

Colour: Army-Green

Model: 1446

Colour: Red

Model: 1345 (19" zipper down outside legs)

Colour: Navy

Model: 1425

Colours: Navy, Grey

Special Call to check availability

Sizes: 30 to 64, also available in tall



BACK

COVERALL

65%/ 35% cotton, 2 front chest pockets, 1 with pencil slot, 1 with flap, 2 front swing pockets, side opening to trouser, 2 rear hip pockets, ruler pocket, concealed nylon zipper, 2 inch yellow PVC stripe reflector tape (2 vertical lines on front, "X" on back, band around arms and legs), reinforced at all points of strain.

Model: 1645

Colour: Navy

Sizes: 30 to 64, also available in tall



MODEL 204 SHOP COAT 100% COTTON



COVERALL

100% cotton, 2 front chest pockets, 1 with pencil slot, 1 with flap, 2 front swing pockets, side opening to trouser, 2 rear hip pockets, ruler pocket, concealed brass zipper, reinforced at all points of strain.

Model: 1442

Colour: Orange

Model: 1444

Colours: Navy, Green, Royal-Blue

Model: 1444W

Colour: White

Sizes: 30 to 64 also available in tall

ARC FLASH SERIES CLOTHING



Clothing made of Nomex IIIA flame resistant material.

Part #	Description
Summer Weight	
CKA176/B	Coverall 4.5 oz - cool blue color, CSA Z462/NFPA 70E Category 1, size 38 to 62*
TKB176/B	Coverall 6.2 oz - cool blue color with 2" yellow-green and silver retro-reflective stripes, CSA Z462/NFPA 70E Category 2, size 38 to 62*
CKB90/B	Shirt 6.2 oz, cool blue color, CSA Z462/NFPA 70E Category 2, size M to 3XL*
CKB110/N	Pant 6.2 oz, navy blue color, CSA Z462/NFPA 70E Category 2, size M to 3XL*

CLOTHING MADE OF NOMEX IIIA



Clothing made of Nomex IIIA flame resistant material.

Part #	Description
Summer Weight	
TN175YG/RB	Coverall 6.2 oz, royal blue, 2" yellow-green and silver retro-reflective stripes, CSA Z462/NFPA 70E Category 1, size 38 to 62*
Winter Work	
CN01LM/RB	Insulated parka 6.2 oz with a FR modacrylic/FR cotton lining, royal blue color, CSA Z462/NFPA 70E Category 1, size S to 3XL*
TN01LM/RB	Insulated parka 6.2 oz with a modacrylic lining, royal blue color with yellow-green and silver triple trim retro-reflective material, CSA Z462/NFPA 70E Category 1, size S to 3XL*
CN130LM/RB	Insulated bib overall 6.2 oz with a modacrylic/cotton lining, royal blue color, CSA Z462/NFPA 70E Category 1, size S to 3XL*

CLOTHING MADE OF WESTEX ULTRASOFT



Clothing made of Indura Ultrasoft flame resistant fabric.

Part #	Description
Summer Weight	
CIW175/RB	Coverall 9.0 oz, royal blue, CSA Z462 / NFPA 70E Category 2, size S to 4XL*
TI175YGRB	Coverall 9.0 oz, royal blue with yellow-green and silver retro-reflective stripes, CSA Z462/NFPA 70E Category 2, size S to 4XL*
Winter Work	
CIW01LM/RB	Parka 9.0 oz, royal blue, CSA Z462/NFPA 70E Category 2, size S to 4XL*

CLOTHING MADE OF WESTEX PROBAN



Clothing made of Westex Proban flame retardant material (9 oz).

Part #	Description
Winter Work	
CW01LC	Insulated parkas - with a cotton lining (4 lb), royal blue or navy blue color, size S to 4XL*

TPU APRONS & SLEEVES



They are a big improvement over PVC products currently available in the marketplace. Accepted by the CFIA (Canadian Food Inspection Agency) for direct food contact.

Part #	Description
CA1T3X3	TPU apron 5.5 mil 35" x 45" with die cut - Blue color
CA2T3X3	TPU apron 5.5 mil 35" x 50" with die cut - Blue color
CA3T3X3	TPU apron 5.5 mil 35" x 45" with adjustable neck strap - Blue color
CA4T3X3	TPU apron 5.5 mil 35" x 50" with adjustable neck strap - Blue color
CE2T3X3	TPU sleeve, covered elastic at each end 18" - Blue color



78001 - Sierra Parka

- Fleece lined collar
- High visibility, lined, stow-away hood with adjustable fit for maximum safety
- Accessory patches for personal locator beacon
- SOLAS reflective striping for maximum visibility
- Double stormflap with velcro closure
- Zippered map pocket accessible under stormflaps
- Left sleeve accessory pockets for pencil, penlight, or light stick; SOLAS approved whistle included
- Front chest fleece lined hand warmer pockets
- External waist belt with dual adjustment buckle
- D-ring for attachment of motor kill switch
- Neoprene adjustable storm cuff with outer zipped over cuff
- Lower cargo pockets with zipper closure and internal D-rings to secure accessories
- Waterproof 210 denier nylon outer shell with polyurethane coating
- Taped seams
- Back neck webbing handle
- Approved to Standard: CAN/CGSB 65.11-M88



HI100, HI200

HI250

HI100 - Manual Inflation

HI200 - Manual Inflation with Automatic Backup

HI250 - Manual Inflation with Harness and Automatic Backup

- Articulated neck
- Short low profile design
- Inflates to a bright yellow colour
- Easy to see service indicator
- Safety whistle included
- 35 lbs of buoyancy
- Approved to Standard: UL1180 with Canadian addendum

To Fit Chest Size: 76cm - 132cm (30" - 52")
Colour: Red/Black

Helly Hansen inflatables are the most compact, comfortable and safe alternative for Department of Transport (Canada) approved PFDs (personal flotation devices). Using the latest in inflation technology, Helly Hansen inflatable PFDs are easy to service and maintain. Great for all seasons, the slim compact design can be worn over any clothing and when inflated has the ability to turn a person face up in the water. Helly Hansen has designed this new generation of inflatable PFDs to meet the needs of the most demanding users.



M504 - Small Vessel Lifejacket

- SOLAS reflective tape on shoulders
- Orange shell
- Grab strap on back of collar
- Safety whistle
- Approved to Standard: CAN/CGSB 65.7-M88

Colour: Orange
Size: Adult Universal

LIFEJACKET...

Lifejackets were developed for professional mariners in the event of emergencies at sea. They were designed to account for more extreme wave conditions, and greater risk of injury to the wearer during abandonment situations. A lifejacket is required to turn an unconscious person to a face-up position, and hold their mouth above the water. These performance requirements cause lifejackets to be very bulky in front, and thus not as comfortable.



CSA (Z96-02) HIGH-VISIBILITY VESTS

2 vertical stripes on front, 360° horizontal stripe around torso & "X" on back.



From

TV52B1/0



TV52B4/L



BACK

Part #	Description	Size
TV52B1/0	2" Yellow North-Brite™ Retro-Reflective Material on a Hi-Viz Orange Polyester Fabric. Meets CSA Table 2A and meets ANSI Class 2, Level 2	M to 4XL*
TV52TAB4/0	4" Yellow North-Lite™ Retro-Reflective Material on a Hi-Viz Orange Polyester Fabric, with tear-away feature. Meets CSA Class 2, Level 2, Table 2A Standards	M to 4XL*
TV52B4/L	2" Silver North-Lite™ Retro-Reflective Material on a Hi-Viz Lime/Yellow Polyester Fabric. Meets CSA Table 2A and meets ANSI Class 2, Level 2	M to 4XL*
TV52TAB4/L	4" Silver North-Lite™ Retro-Reflective Material on a Hi-Viz Lime/Yellow Polyester Fabric, with tear-away feature. Meets CSA Class 2, Level 2, Table 2A Standards	M to 4XL*



F

TV50RS



BACK

REGULAR HIGH-VISIBILITY VESTS



2 vertical stripes on front & "X" on back.

Part #	Description	Size
TV50RS	2" yellow North-Brite™ Retro-Reflective Material on a Bright Orange Polyester Mesh Fabric. Front Velcro Closure and a elastic with buckle on both sides	Reg & XL



From

Sugg. list price

TV51RSBC



TV51RSTAONT



BACK

2 vertical stripes on front, 360° horizontal stripe around torso & "X" on back.

Part #	Description	Size
TV51RSBC	2" yellow North-Brite™ Retro-Reflective Material on a Bright Orange Polyester Mesh Fabric. Meets BC Specs	One Size
TV51RSTAONT	2" yellow North-Brite™ Retro-Reflective Material on a Bright Orange Polyester Mesh Fabric. with a Tear Away Feature. Meets Ontario Specs	One Size



From

S

TV50RS/2AS



TV51RSTA/2



BACK

DAYTIME HIGH-VISIBILITY VESTS

2" Yellow Day-Lite™ Fluorescent Stripes on Bright Orange Polyester Mesh Fabric.

Part #	Description	Size
TV50RS/2AS	2 vertical stripes on Front, "X" on back and a elastic adjustment on sides	One Size
TV51RSTA/2	2 vertical stripes on Front, "X" on back, horizontal stripes on sides and a 5 point "tear-away" feature	One Size



From

Sugg. list price

TV98CYG/0



BACK

SURVEYOR'S HIGH-VISIBILITY VESTS



2 vertical stripes on front & "X" on back.

Part #	Description	Size
TV98CYG/0	2" yellow/silver/yellow North-Brite™ Retro- Reflective Material on a Bright Orange cotton fabric. 4 snap closure in front and 4 pockets	M to 2XL*



POLICE

TRANSPORT

EMS

RESPONDER VESTS

Professional Line of High Visibility Safety Vests for emergency personnel deployed on roadways in response to an accident, emergency and other workplace situations. Meets CSA Level 2, Table 2A.

2 VERTICAL STRIPES ON FRONT, 360° HORIZONTAL STRIPE AROUND TORSO & "X" ON BACK.

Part #	Description	Size
TV2A2K1	Blue retro bands on a fluorescent orange polyester fabric - (1) inside pocket	S to 3XL*
TM4C2K1	Blue retro bands on a fluorescent orange polyester fabric - multiple pocket & loops	S to 3XL*
TM4C4K1	Blue retro bands on a fluorescent yellow/green polyester fabric, multiple pocket & loops	S to 3XL*
TV2A4L1	Orange retro bands on a fluorescent yellow/green polyester fabric - (1) inside pocket	S to 3XL*
TM4C4M1	Green retro bands on a fluorescent yellow/green polyester fabric, multiple pocket & loops	S to 3XL*



TV01E012



BACK

HIGH-VISIBILITY PARKAS

Zipper closure, 2 vertical stripes on front, a 360° horizontal stripe around torso & arms and "X" on back. Meets CSA Class 2, Table 2. Available in size S to 3XL*.



Part #	Description
TV01/E072	2" Silver North-Lite™ Retro-Reflective Material on a Bright Orange Poly-Cotton Fabric
TV01E012	2" Yellow North-Lite™ Retro-Reflective Material on a Bright Orange Poly-Cotton 65/35 Fabric



TVIW130LCG/O



BACK

HIGH-VISIBILITY BIB PANT

Zipper closure, 2 vertical stripes on front, "X" on back, a 360° horizontal stripe around torso & legs with a side zipper on legs. Meets CSA Class 2, Table 2. Available in size M to 3XL*.



Part #	Description
TVIW130LCG/O	Fire Retardant Bright Orange Westex Proban Fabric with a 2" Yellow North-Lite™ Retro-Reflective Material



HIGH-VISIBILITY COVERALLS

High-visibility coverall with a zipper closure, 2 vertical stripes on front, "X" on back and a 360° horizontal stripe around torso & legs. Available in size M to 3XL*.



Part #	Description	CSA
TV175/F082	2" Silver North-Lite™ Retro-Reflective Material on a Bright Orange Poly-Cotton Fabric	Class 3, Level 2 Table 2
TVPC175/O	2" Silver North-Lite™ Retro-Reflective Material with contrasting yellow green stripes on a fluorescent Orange Poly-Cotton Fabric. CSA Z96 - Available spring 2009	Class 3, Level 2, Table 2A
TVPP172/L	4 1/2" duo-color orange/silver North-Lite™ retro-reflective Material one yellow/green lightweight polyester Fabric	Class 3 Table 2A



TVPC175/O



BACK

*



CSA (Z96-02) HIGH-VISIBILITY T-SHIRT & SWEAT SHIRT

High-visibility t-shirt and sweat shirt with 2 vertical stripes on front, a 360° horizontal stripe around torso and a "X" on back. Meets CSA Table 2A. Available in size S to 3XL*.

Part #	Description
TV96TSLY	T-shirt - 2" Silver North-Lite™ Retro-Reflective Material on a Hi-Viz Yellow/Green 100% Polyester Fabric
TV96SSLY	Sweat shirt - 2" Silver North-Lite™ Retro-Reflective Material on a Hi-Viz Yellow/Green 50% cotton/50% Polyester Fabric



HIGH-VISIBILITY T-SHIRT

"V" neck t-shirt with 2 vertical stripes on front "X" on back and a horizontal stripes on each side for TV94TSBC (meets British-Columbia standards). Available in size S to 3XL*.

Part #	Description
TV35TS	2" Yellow North-Lite™ Retro-Reflective Material on a Bright Orange 100% Cotton Fabric
TV94TSBC	2" Yellow North-Brite™ Retro-Reflective Material on a Fluorescent Orange Polyester Sport Mesh Type



INSULATED HIGH-VISIBILITY PARKAS

Zipper closure, 2 vertical stripes on front, a 360° horizontal stripe around torso & arms and "X" on back. Meets CSA Class 2, Table 2. Available in size M to 3XL*.

Part #	Description
TV01E012	2" yellow North-Lite™ Rétro-Reflective material on a Bright Orange Poly-Cotton 65/35 Fabric
TVIW01LC/0	2" Yellow North-Lite™ Retro-Reflective Material on a Fire Retardant Bright Orange Westex Proban Fabric with a Modacrylic Lining



INSULATED HIGH-VISIBILITY BOMBER

Zipper closure, 2 vertical stripes on front, "X" on back and a 360° horizontal stripe around torso. Meets CSA Class 2, Table 2B. Available in size M to 3XL*.

Part #	Description
TV30/E012	Insulated Bright Orange Poly-Cotton 65/35 fabric & Lining with a 2"yellow North-Lite™ Retro-Reflective Material



INSULATED HIGH-VISIBILITY BIB PANT

Zipper closure, 2 vertical stripes on front, "X" on back, a 360° horizontal stripe around torso & legs with a side zipper on legs. Meets CSA Class 2, Table 2. Available in size S to 3XL*.

Part #	Description
TV130/E092	Insulated Bright Orange Poly-Cotton fabric & Lining with a 2" Silver North-Lite™ Retro-Reflective Material





A79R31/GY

ANSI Type 1



HIGH-VISIBILITY HARD HATS

Highly Visible Fluorescent Orange Hard Hat with 3 Yellow North-Brite™ Stripes 1" x 4" (2.5cm x 10cm) on Sides and Back.

Part #	Color	Shell	Adjustment
A79R31/GY	Fluorescent orange	HDPE	Ratchet



A79R44/GS

Highly Visible Fluorescent Lime/Yellow Hard Hat with 3 Silver North-Lite™ Stripes 1" x 4" (2.5cm x 10cm) on Sides and Back.

Part #	Color	Shell	Adjustment
A79R44/GS	Lime/Yellow	HDPE	Ratchet



TV25CSA

TV20E

HIGH-VISIBILITY SASH BELTS



Sash belts with a retro-reflective material.

Part #	Description	Size
TV25CSA	2" yellow North-Brite™ retro-reflective material sewn on a orange nylon fabric. Meets CSA Class 1, Level 2	M to 2XL*
TV20E	1 1/2" yellow/silver/yellow retro-reflective material, elasticized	One size

*2XL +10%



SCS16

SCS14

HIGH-VISIBILITY ARMBANDS



With velcro closure.

Part #	Description
SCS16	Yellow North-Brite™ retro-reflective material
SCS14	Yellow North-Brite™ retro-reflective material on a Orange Nylon



FLA16/GR

FLA22/GR

FLA25

TRAFFIC FLAGS

Part #	Description
FLA16/GR	Bright orange Nylon, 16" x 16" with a dowel sleeve
FLA22/GR	PVC mesh orange nylon, 18" x 18" with 3 grommets
FLA25	Bright orange Nylon 18" x 24" with a reflective cross on each side, dowel sleeve
XG4	Wooden dowel for flags, 36"



XG29

REFLECTOR FLARES

Part #	Description
XG29	Set of 3 reflector flares

Viking Safety Vest

6135G Breathable solid polyester material
Fit-All and XXL oversize; Fits over most jackets
Fully compliant with CSA Z96-02 Class 2 Level 2
Becomes CSA Class 3 in combination with right model
arm and leg bands
Fully compliant with ANSI/ISEA 107-2004 Class 2 Level 2
2" 3M Scotchlite reflective material in 4" WCB/Worksafe/DOT configuration
Safety D ring slot access
5 point velcro tear away design
Four front pockets
Fit-All adjustable sizing

6135G



Journeyman T-Shirt

Safety T-Shirts
New non-transparent double layer premium mesh polyester material, soft and breathable
Fully compliant with CSA Z96-02 Class 2, Level 2
Becomes CSA Class 3 in combination with right model
arm and leg bands
Fully compliant with ANSI/ISEA 107-2004 Class 2 Level 2
2" 3M Scotchlite reflective material in 4" WCB/Worksafe/DOT configuration
Left chest velcro sealed cell phone pocket and pen slot
Clip on straps on both chests for radio phone
Available in sizes S-3XL

60060

6006G



Journeyman 3010

Jacket & pant features:
New H.D. 300D Trilobal Ripstop Polyester material
Re-engineered to eliminate dye bleeding while maintaining high tensile Ripstop feature
Resistant to abrasion, puncture, rips and snags
Flexible in sub-zero conditions
Multi-vented and full mesh lining
Two front pockets & chest cell pocket
Hood #3010H - sold separately
Removable bib & boot zip on pants
Available in S-4XL

3010P

3010J



Viking

Heavy Duty Industrial Outerwear

VIKING

MINER BOOTS



VW49 Viking Miner 49ER Professional Mining Boot

14 Inches - CSA Class #1 Steel Toe & Plate

Boot Features

- :: CSA Omega- Electric Shock Resistant
- :: ANSI MT/75 Metatarsal Protection
- :: Handcrafted, 100% waterproof, natural rubber
- :: Heavy duty cotton canvas lining
- :: Air cushioned sole pockets
- :: Oil and chemical resistant nitrile lug sole
- :: Achilles tendon and ankle protection
- :: Removable comfort felt insole



VW76 Viking Ericson Boot

Lug Sole - CSA Class #1 Steel Toe

Boot Features

- :: Hand-built 100% natural rubber bottom
- :: Full grain, water-resistant leather tops
- :: Ballistic nylon, cut-resistant protection, in front of boot
- :: Heavy-duty 100% cotton canvas lining
- :: Steel shank
- :: Nitrile oil, chemical & slip resistant lug sole adaptable for ice studs
- :: Felt insole for comfort
- :: Made in Canada



VW8-3 Viking Journeyman 15" Knee Boot

Lug Sole - CSA Class #1 Steel Toe & Plate

Boot Features

- :: CSA Omega- Electric Shock Resistant
- :: Handcrafted using 100% waterproof and oil resistant natural rubber
- :: Self cleaning rubber lug sole adaptable for ice studs
- :: Extra layers of rubber provide metatarsal protection
- :: Tough and comfortable cotton canvas lining

Industrial & Utility



CARLETON forest green

4287-15 M 51" ST-T/ST-P/ESR/CSA1 6-13F

Outsole: Suretred

Lightweight breast-high natural rubber wader for workers. CSA1 electric shock resistant outsole and heel, steel toe and plate. Chest lacing. Adjustable elastic web braces with reinforced buttons at the rear. Inside pocket.

Also available:

4187-15 M/W* 51" Reg. toe (medium) 3-13F



CARLETON
4287-15



WARDEN

black

3256-11	M	10"	Work	6-13F
3257-11	M	10"	Husky II	6-13F
3257-11X	M	10"	Husky II(XL)	14F
3258-11	M	10"	Trufit	6-13F
3258-11X	M	10"	Trufit (XL)	14-15F

Outsole: Suretred

Natural rubber overshoe with four buckles. Fleece lining. Full bellows tongue.



PROTECTO
4148L11

PROTECTO black

4148L11 M 29" ST-T/ST-P/ESR/CSA1 6-13F

Outsole: Cleat

Natural rubber stormking with red and green trims with CSA1 steel toe and plate. Osnaburg lining. CSA 1 electric shock resistant outsole and heel.

Also available:

4135L11 M/W* 15" ST-T/ST-P/ESR/CSA1 3-13F



PROTECTO black

4135L11 M/W* 15" ST-T/ST-P/ESR/CSA1 3-13F

Outsole: Cleat

Natural rubber boot with red and green trims with CSA1 steel toe and plate. Osnaburg lining. CSA1 electric shock resistant outsole and heel.

* For women's sizes, order two sizes smaller.

Also available:

4148L11 M 29" ST-T/ST-P/ESR/CSA1 6-13F

SNUGGER

black

3175-11	M	10"	Haig	6-13F
3176-11	M	10"	Burt	6-13F
3176-11X	M	10"	Burt(XL)	14-15F
3276-11	M	10"	Husky	6-13F

Outsole: Suretred

Natural rubber overshoe for work boots with wide full bellows tongue, adjustable strap and buckle.



VICTORIA
1301-11



IT12ST01WHT

IT12PT17BLU



MT15ST17BLU

FOOD PROCESSING OVERSHOE

12, 15 or 20 inches overshoe that may be fully sanitized inside and out. Extremely lightweight, 100% waterproof with slip resistant sole. Available in sizes XS to 3XL with soft toe or steel toe.

Part #	Toe	Height	Color
IT12PT17BLU	Soft	12 in	Blue
IT20PT17BLU	Soft	20 in	Blue
IT12ST01WHT	Steel	12 in	White
IT12ST17BLU	Steel	12 in	Blue
IT20ST17BLU	Steel	12 in	Blue
MT15ST17BLU	Steel	15 in	Blue

ALL SEASON OVERSHOES



VIS1BLK



VNN1BLK or VNS1BLK



ANN1BLK



TRS7BRN



UNX1BLK



N5P3GRY or N5P3SGRY



SUPERLITE OUTSOLE



PERMA OUTSOLE



VIBRAM® NINJA OUTSOLE



STABILicers® OUTSOLE

Part #	Description	Size
VIS1BLK	VILLAGER™ - 10" (25.4 cm) Superlite outsole - Black color	XS to 2XL
VNN1BLK	VOYAGER™ - 11" (27.9 cm) Perma outsole - Black color	XS to 3XL
ANN1BLK	ADVENTURER™ - 15" (38.1 cm) Perma outsole - Black color	XS to 2XL
TRS7BRN	TREKKER™ - 20" (50.8 cm) Superlite outsole - mushroom color	XS to 2XL
SNN1BLK	SURVEYOR™ - 20" (50.8 cm) Perma outsole - Black color	XS to 2XL
RTK7BRN	RIVER TREKKER™ - 30" (76.2 cm) Vibram® Ninja outsole - mushroom color	XS to 2XL

INSULATED OVERSHOES

Part #	Description	Size
UNX1BLK	UPTOWNER X™ - 9" (22.9 cm) Perma outsole - Black color	XS to 2XL
EXPGBLK	EXPLORER™ - 11" (27.9 cm) Perma outsole - Black color	XS to 3XL
N5P3GRY	NAVIGATOR 5™ - 15" (38.1 cm) Vibram® Ninja outsole - Gray color	XS to 2XL

ANTI-SLIP OVERSHOES

Part #	Description	Size
VNS1BLK	VOYAGER™ STABILicers® - 11" (27.9 cm) STABILicers® outsole - Black color	XS to 3XL
EXSGBLK	EXPLORER™ STABILicers® - 11" (27.9 cm) STABILicers® outsole - Black color	XS to 3XL
N5P3SGRY	NAVIGATOR 5™ STABILicers® - 15" (38.1 cm) STABILicers® outsole - Gray color	XS to 3XL



SERVUS PRM

Part #	Description
75145C	Servus PRM - Black/orange knee boot - 15 in (38.1 cm) Safe-Toe steel toe and Safe-Step steel midsole removable EVA Foot Form contour insoles ergonomic footbed - Whole sizes: Men's 7 to 14



PVC VALUE LINE

Black knee boot - 15in (38.1 cm) - EVA Foot Form contour insoles.

Part #	Description
18822C	Servus CT™ - Black knee boot - Plain toe Trac10™ sole design -Whole sizes: Men's 3 to 15
18821C	Servus CT™ - Black knee boot - Safe-Toe steel toe Trac10™ sole design - Whole sizes: Men's 3 to 15
75125C	Servus® - Black knee boot - Safe-Toe steel toe and Safe-Step steel midsole ergonomic footbed Whole sizes: Men's 7 to 14



RUBBER REGULAR LINE

Olive drab knee boot - 12in (30.5 cm) - Safe-Toe steel toe and Safe-Step steel midsole.

Part #	Description
2149C	Ranger Flex-Guard - Flex-Guard metatarsal guard heavy trac tread sole - ultra composite shanks Whole sizes: Men's 5 to 13



PVC PREMIUM LINE

15 in (38.1 cm) - Safe-Toe steel toe - EVA Foot Form contour insoles - extended ribbed steel shank.



RUBBER REGULAR LINE

Black knee boot - 15in (38.1 cm) - Safe-Toe steel toe and Safe-Step steel midsole steel midsole.

Part #	Description
4301C	Ranger Turtleback Mining - Full metatarsal guard removable Foot form contour cushion insoles ergonomic footbed - Whole sizes: Men's 5 to 13

Part #	Description
75109C	Servus XTP - Black/Yellow/Gray knee boot Whole sizes: Men's 3 to 15
75101C	Servus Pro - Gray/Yellow/Black knee boot Whole sizes: Men's 5 to 15



NEOPRENE PREMIUM LINE

Copper tan boot - 16in (40.6cm) - Safe-Toe steel toe.

Part #	Description
22214C	Servus Neoprene Safety Hi Pac - Breathe-O-Prene® cushion insoles - chevron sole and heel Whole sizes: Men's 3 to 15



MUCK BOOT LINE

EVA removable cushion insoles.

Part #	Description
EWC333T	Edgewater® Camp sport shoe - Moss TracTrol™ outsole - Men's whole sizes: 5 to 14
JOB000A	Jobber™ Work boot - 6 in (15.2 cm) - Black - Diamond tread outsole Kick rim - Men's whole sizes: 5 to 14
CHM00A	Chore™ Mid Work boot - 12 in (30.5 cm) - Black Rubber outsole - Kick rim - Men's whole sizes: 5 to 16
CHH000A	Chore™ Hi Work boot - 16 in (40.6 cm) - Black Rubber outsole - Kick rim - Men's whole sizes: 5 to 16
CHS000A	Chore™ Hi Safety boot - 16 in (40.6 cm) - Black - Steel toe Rubber outsole - Kick rim - Men's whole sizes: 5 to 14

TERRA®



WILD SIDER®



MERCENARY

8" Insulated Terra Wild Sider Mercenary® features full grain water resistant Terra®-ized leather, a lightweight direct injected polyurethane midsole with a heat, oil & acid resistant outsole, removable deluxe Terra Footbed®, breathable Cambrelle® lining, B200 Thinsulate® insulation, CSA grade 1 steel toe and puncture resistant steel plate, ESR electric shock resistant.

7996

BLACK FRONTIER

Sizes: 6, 7-11, 12, 13



REGULATOR

Terra Wild Sider® Regulator features full grain water resistant Terra®-ized leather upper, lightweight direct injected two density polyurethane sole, breathable Cambrelle® lining, B200 Thinsulate® insulation, removable Terra Footbed®, CSA steel toe and puncture resistant steel plate, ESR electric shock resistant.

6969

BONE CRAZY WEATHER

Sizes 6, 7-11, 12, 13



NORWEGIAN

Terra Wild Sider® Norwegian, full grain water resistant Terra®-ized leather upper, lightweight direct injected two density polyurethane sole, breathable Cambrelle® lining, B200 Thinsulate® insulation, removable Terra Footbed®, CSA Grade 1 steel toe and steel plate, ESR electric shock resistant.

8974

DOGWOOD

Sizes 4, 5, 6, 7-11, 12, 13



Repeater (Camel Goldrush)

STYLE 9900 Sizes: 7-11,12,13



- Lightweight direct injected two-density polyurethane sole and toe bumper is bonded directly onto the leather upper. The vamp area is completely lined with leather for maximum durability.
- Full grain Terra-ized water resistant North American leather uppers
- Steel toe and steel plate (CSA Grade 1-E.S.R. / ANSI I75-C75 / CE EN345 SB-P-WRU-E-CI)
- Removable cushioned Terra Footbed
- Made in Canada

Repeater (Black Manitou)

STYLE 9918 Sizes: 7-11,12,13



- Lightweight direct injected two-density polyurethane sole and toe bumper is bonded directly onto the leather upper. The vamp area is completely lined with leather for maximum durability.
- Full grain Terra-ized water resistant North American leather uppers
- Steel toe and steel plate (CSA Grade 1-E.S.R. / ANSI I75-C75 / CE EN345 SB-P-WRU-E-CI)
- Removable cushioned Terra Footbed
- Made in Canada

Replay (Black Manitou)

STYLE 9968 Sizes: 6,7-11,12,13



- Lightweight direct injected two-density polyurethane sole and toe bumper is bonded directly onto the leather upper. The vamp area is completely lined with leather for maximum durability.
- Full grain Terra-ized water resistant North American leather uppers
- Steel toe and steel plate (CSA Grade 1-E.S.R. / ANSI I75-C75)
- Removable cushioned Terra Footbed
- Made in Canada

Replay (Camel)

STYLE 9969 Sizes: 6,7-11,12,13,14

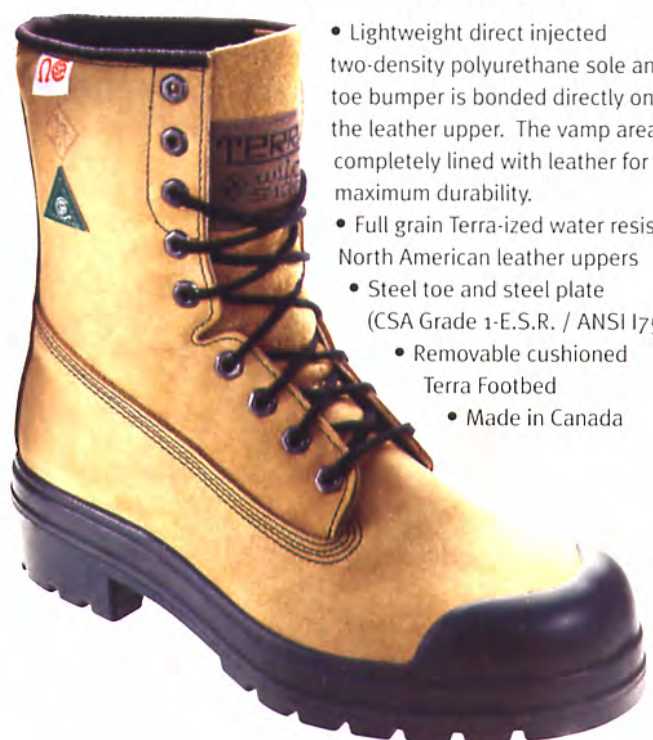

- Lightweight direct injected two-density polyurethane sole and toe bumper is bonded directly onto the leather upper. The vamp area is completely lined with leather for maximum durability.
- Full grain Terra-ized water resistant North American leather uppers
- Steel toe and steel plate (CSA Grade 1-E.S.R. / ANSI I75-C75)
- Removable cushioned Terra Footbed
- Made in Canada

Titan Full-Body Harnesses

Daloz Fall Protection introduces **Titan by Miller**, a new line of construction-grade fall protection products for price-sensitive users.

Quality Assurance

Titan fall protection products are manufactured by the leading supplier of fall protection in North America. That means the same quality workmanship you've come to know and expect from Miller brand products is used in the production of Titan products as well. Daloz Fall Protection is committed to consistent, high quality in the design, development, production, installation and service of all its products – the Franklin, PA facility is ISO 9001 certified. With Titan fall protection products, you won't have to sacrifice quality for a better price.



Model T4007

One "universal" size fits most.

Lightweight, durable polyester webbing for all day comfort and dependability

- Fully adjustable designs
- Sliding back D-ring
- Sub-pelvic strap
- Trilingual labeling and instructions

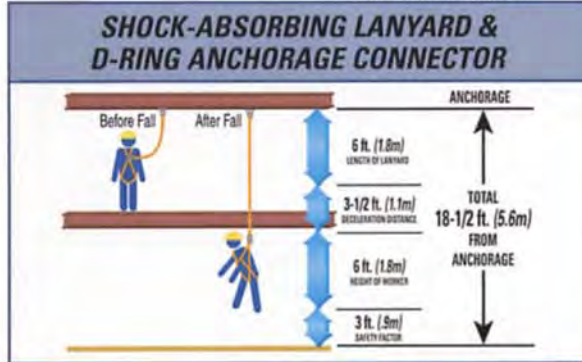

Titan Shock-Absorbing Lanyards



Model T5111



Model T5121



Model T5112



Model T5113



Model T5122



Model T6111

Versatile, Shock-Absorbing Lanyard Designs

Tubular Shock-Absorbing Lanyards feature a built-in woven inner core which smoothly expands to reduce fall arrest forces, while the outer jacket serves as a back-up web lanyard.



Miller Non-Stretch 650 Series



- Lightweight nylon webbing
- Belt loops to accommodate belts, back pads and other accessories
- Front D-ring (optional)

Carabiners 17D-1/17D-2, 18D-1/18D-2

Convenient, twist-lock carabiners have an unlimited number of uses.



17D-1

Steel Carabiner
1" (25mm)
gate opening



17D-2

New
Lightweight Aluminum Carabiner
1" (25mm)
gate opening



18D-1

Steel Carabiner
2" (50mm)
gate opening



18D-2

New
Lightweight Aluminum Carabiner
2-1/4" (57mm)
gate opening

Four Functional Equipment Categories



Items highlighted in yellow are class "A" stocked items

RITE-ON™

The RITE-ON harnesses are designed with two things in mind: Simplicity and Comfort. The comfort pad eliminates the tangling of the straps which are common with traditional harnesses. The bayonet style connectors allow users to connect their chest and legs straps in a single action. The RITE-ON harnesses are designed to have workers wear them all day without the need to remove them.



Part #	Class	D-rings
FP81F/1DBA	Fall arrest	(1) large back D-ring
FP81F/1EDBA	Fall arrest	(1) large back D-ring with extender
FP81F/3DDA	Fall arrest, work positioning	(1) large back (2) large sides D-rings
FP81F/3DIA	Fall arrest, Evac./Retrieval	(2) small shoulder D-rings (1) large back D-ring
FP81F/4DLA	Fall arrest, work positioning ladder climbing	(1) large back, (2) large sides (1) small sternal D-ring
FP81M/3DDA	Fall arrest, work positioning	(2) large sides (1) large back D-ring + ergonomic lumbar support Sizes: US, UM, UL, XLXL
FP81M/6D3A	Fall arrest, work positioning ladder climbing Evac./Retrieval	(2) large sides (2) large shoulder D-ring (1) small sternal D-ring (1) large back D-ring Sizes: US, UM, UL, XLXL



VEST-STYLE UNIVERSAL HARNESSSES

Adjustable shoulder straps and a chest strap that can be positioned in the optimum location for the user, eliminating any need for stretchable webbing. Available in universal size and extra-large (XL).

Part #	Class	D-ring
FP759/1DP	Fall arrest	(1) Large back D-Ring
FP759/1EDP	Fall arrest	(1) Large back D-Ring with extender
FP759/1DGP	Fall arrest	(1) Large back D-Ring



TREND-X CROSS-CHEST HARNESSSES

Trend-X is the ultimate in fit and utility. It comes in polyester webbing and is equipped with North's exclusive D-Stop strap in the back to help keep you in the harness in case of a fall. Available in universal size and extra-large (XL).

Part #	Class	D-ring
FP721/1DP	Fall arrest	(1) Large back D-ring
FP722/2DP	Fall arrest, Descent, Ladder climbing	(1) Large back D-ring (1) Front D-ring
FP722/4DP	Fall arrest, Descent, Work positioning, Ladder climbing	(1) Large back D-ring (1) Front D-ring (2) Side D-ring
FP722/6DP	Fall arrest, Descent, Work positioning, Ladder climbing Confined space	(1) Large back D-ring (1) Front D-ring (2) Shoulder D-ring (2) Side D-ring



HEAVY DUTY HARNESS & LANYARD COMBO'S

Rite-On Heavy duty fall protection system. This full body harness and energy absorber combination is rate for worker up to 440lbs (200Kg). This universal full body harness has a integrated energy absorber, adjustable shoulder straps and grommetted legs straps for easy donning.

Part #	Class	D-ring
FP80K/3DYQ320	Fall arrest, work position.	(2) large sides (1) large back D-ring w/extender

VEST-STYLE SIZED HARNESSSES



Sized full body harnesses provide the ultimate in comfort and safety. North designed this lightweight harness complete with a sub-pelvic strap to help evenly distribute the forces generated in a fall. Available in small (S), medium (M), large (L), XL and 2XL.

Part #	Class	D-ring
FP700/1D	Fall arrest	(1) Small Back D-ring
FP700/1ED	Fall arrest	(1) Small back D-ring with extender
FP700/3D	Fall arrest Work positioning	(1) Small Back D-ring (2) Sides D-ring
FP700/3ED	Fall arrest Work positioning	(1) Small Back D-ring with extender (2) Sides D-ring
FP703/3D	Fall arrest Confined space	(1) Small Back D-ring (2) Shoulder D-ring
FP705/5D	Fall arrest Work positioning Descent	(1) Small Back D-ring (2) Sides D-ring (1) Sternal Loops



“CONTRACTORS’ CHOICE”

By **NORTH**

FULL BODY HARNESS



Part #	Description	Size	D-rings
FPD698/1DP	Full Body Harness Lightweight polyester	Universal	Large back D-ring
FPD698/1DPXL	Full Body Harness Lightweight polyester	XL	Large back D-ring
FPD698/1DGP	Full Body Harness Light weight polyester w/grommetted legs	Universal	Large back D-ring
FPD698/1DGPXL	Full Body Harness Light weight polyester w/grommetted legs	XL	Large back D-ring
FPD698/3DGP	Full Body Harness Light weight polyester w/grommetted legs	Universal	Large back D-ring & 2 large side D-rings
FPD698/3DGPXL	Full Body Harness Light weight polyester w/grommetted legs	XL	Large back D-ring & 2 large side D-rings

DECELERATOR®



Part #	Description	Connector		Length
		Harness	Anchor	
FPD29811/4	Polyester Decelerator Energy Absorbing Lanyard	Double locking snap-hook	Double locking snap-hook	4ft (1.2 m)
FPD29811/6	Polyester Decelerator Energy Absorbing Lanyard	Double locking snap-hook	Double locking snap-hook	6ft (1.8 m)
FPD29819/4	Polyester Decelerator Energy Absorbing Lanyard	Double locking snap-hook	Double locking rebar hook	4ft (1.2 m)
FPD29819/6	Polyester Decelerator Energy Absorbing Lanyard	Double locking snap-hook	Double locking rebar hook	6ft (1.8 m)

COMBOS

These combos include a harness with a permanently attached 4' (1.2 m) or 6' (1.8 m) Decelerator energy absorbing lanyard with a double locking snap-hook or double locking rebar hook.



Part #	Description	Size
FPDCOMB01/4	Double locking snap hook	4ft (1.2 m)
FPDCOMB01XL/4	Double locking snap hook	4ft (1.2 m)
FPDCOMB01/6	Double locking snap hook	6ft (1.8 m)
FPDCOMB01XL/6	Double locking snap hook	6ft (1.8 m)
FPDCOMB02/4	Double locking rebar hook	4ft (1.2 m)
FPDCOMB02XL/4	Double locking rebar hook	4ft (1.2 m)
FPDCOMB02/6	Double locking rebar hook	6ft (1.8 m)
FPDCOMB02XL/6	Double locking rebar hook	6ft (1.8 m)



AERIAL KITS

These combos include a harness with a permanently attached 4' (1.2m) or 6' (1.8m) Decelerator energy absorbing lanyard with a double locking snap-hook or double locking rebar hook and Durabilt carrying bag.

Part #	Description
FPDKIT1/4	Aerial kit with 4' (1.2m) lanyard
FPDKIT1XL/4	Aerial kit with 4' (1.2m) lanyard and XL harness
FPDKIT1/6	Aerial kit with 6' (1.8m) lanyard
FPDKIT1XL/6	Aerial kit with 6' (1.8m) lanyard and XL harness



CONSTRUCTION KITS

Contains: Polyester full body harness, polyester Decelerator energy absorbing lanyard with a double locking snap hook (4 or 6 ft), T'NT spectra sling and Durabilt carrying bag.

Part #	Description
FPDKIT2/4	Construction kit with 4' (1.2m) lanyard
FPDKIT2XL/4	Construction kit with 4' (1.2m) lanyard and XL harness
FPDKIT2/6	Construction kit with 6' (1.8m) lanyard
FPDKIT2XL/6	Construction kit with 6' (1.8m) lanyard and XL harness



SCAFFOLDING/FORMING KITS

Contains: Polyester full body harness, polyester Decelerator energy absorbing lanyard with a double locking snap hook and 2-1/2" stamped scaffolding hook and Durabilt carrying bag.

Part #	Description
FPDKIT3/4	Scaffolding/Forming kit with 4' (1.2m) lanyard
FPDKIT3XL/4	Scaffolding/Forming kit with 4' (1.2m) lanyard and XL harness
FPDKIT3/6	Scaffolding/Forming kit with 6' (1.8m) lanyard
FPDKIT3XL/6	Scaffolding/Forming kit with 6' (1.8m) lanyard and XL harness



REBAR KITS

Contains: Polyester full body harness, polyester Decelerator energy absorbing lanyard with double locking snap hook and 2-1/2" stamped scaffolding hook, rebar assembly and Durabilt carrying bag.

Part #	Description
FPDKIT4/4	Rebar kit with 4' (1.2m) lanyard
FPDKIT4XL/4	Rebar kit with 4' (1.2m) lanyard and XL harness
FPDKIT4/6	Rebar kit with 6' (1.8m) lanyard
FPDKIT4XL/6	Rebar kit with 6' (1.8m) lanyard and XL harness



ROOFER'S KITS

Contains: Lightweight universal harness, soft pack energy absorbing lanyard with rope grab permanently attached, 3-strand co-polymer rope 5/8" (16 mm), Roof bracket, 4" (100 mm) Ardox spiral nails and Durabilt convenient bucket.

Part #	Description
FPD90/25	With 25' (8m) of rope
FPD90/50	With 50' (16m) of rope

TY-RITE

An adjustable shock absorbing lanyard with a built-in anchor sling. Not only will this reduce the number of pieces your workers need to carry to the job site, we have also made it adjustable so that there is no need to have different lengths of lanyards available. The Ty-Rite lanyard is adjustable from 6' to 3' which makes it compatible with most applications. The Ty-Rite lanyard is CSA approved and meets or exceeds ANSI and OSHA requirements.



Part #	Description	Application
FP2HT2Q/6	Single leg adjustable 6' with (1) regular snap hook and (1) quad lock carabiner	Fall arrest
FP2HY2Q/6	Y-lanyard adjustable 6' with (1) regular snap hook and (2) quad lock carabiner	For continuous Fall arrest protection

NORTH DECELERATOR® ENERGY ABSORBING LANYARDS



With ergonomic double locking snap and flagging system. Available in 4' (1.2 m) or 6' (1.8 m) long.

Part #	Material	Hardware	Length
FP28822/4	Nylon	(2) Self Locking Snaps	4' (1.2 m)
FP28822/6	Nylon	(2) Self Locking Snap	6' (1.8 m)
FP2882G/4	Nylon	(1) Self Locking Snap (1) Scaffold Hook	4' (1.2 m)
FP2882G/6	Nylon	(1) Self Locking Snap (1) Scaffold Hook	6' (1.8 m)

SOFT PAK ENERGY ABSORBING Y-LANYARDS



Shock absorbing Y-lanyards with various styles of snap hooks to choose from. 6 feet (1.8 m) long.

Part #	Material	Hardware	Length
FP266222/6	Polyester	(3) self locking snaps	6' (1.8 m)
FP2662GG/6	Polyester	(1) Double Locking Snap/ (2) Scaffold Hooks	6' (1.8 m)

TNT SLING



Ideal for rebar or concrete forming.

Part #	Material	Length
FP242/4	Spectra	4' (1.2 m)
FP242/5	Spectra	5' (1.5 m)
FP242/6	Spectra	6' (1.8 m)

SOFT PAK ENERGY ABSORBING LANYARDS



With ergonomic double locking snaps. 1-3/4" (45 mm) webbing 6 feet long.

Part #	Material	Hardware	Length
FP26322/4	Polyester	(2) Self locking snaps	4' (1.2 m)
FP26322/6	Polyester	(2) Self locking snaps	6' (1.8 m)

ANCHOR SLING



PVC coated steel sling.

Part #	Material	Length
FP02/4	PVC coated sling	4' (1.2 m)
FP02/6	PVC coated sling	6' (1.8 m)

Duralite III

Self Retracting Lifeline

Until now fall arrest blocks were either relatively heavy and serviceable or lightweight and disposable. The NEW North Duralite III combines the best of both. Its plastic housing and web lanyard result in a very low weight device and it's all metal internal components give us the ability to repair the unit at a low cost. The Dyneema® webbing has been engineered to make this unit light weight and strong. Unlike other units on the market, the Duralite III has the ability to fully retract the entire length of the webbing, thus reducing the risk of dangerous slack while at the same time allowing the worker an extra few feet of workable length.

Part #	Description	Length
FP1/303W	Nylon composite housing, fall arrest CSA Type 1	10' (3 m)
FP1/304W	Nylon composite housing, fall arrest CSA Type 2	12' (3.6 m)



FP2 SERIES SELF-RETRACTING LIFELINES

Stainless cable, 3/16" (5mm), compact and durable construction, sealed unit that is easy to operate.

Part #	Description	Length
FP2/310S	Regular housing	33' (10m)
FP2/315S	Regular housing	50' (15m)



FP3 SERIES SELF-RETRACTING LIFELINES

Stainless cable, 3/16" (5mm), compact and durable construction, sealed unit that is easy to operate.

Part #	Description	Length
FP3/333S	Large housing	110' (33m)



Duralite II

Self Retracting Lifeline

From

The Duralite II offers a light-weight solution to the 20 feet (6 m) self-retracting series of fall arrester. This unit has a composite housing with 3/4" (20mm) spectra webbing and two swivels, which is also serviceable.

Part #	Description	Length
FP1/306W	Composite housing	20' (6m)



RETRACTABLE WEB LANYARD

Retractable web lanyards are the lightest SRL's available. They are engineered to provide maximum protection in places where fixed lanyards might get in the way.

Part #	Description	Length
FP0301	With Carabiner	8' (2.4m)
FP0303	With Double Locking Snap Hook	8' (2.4m)
FP0304	With Locking Swivel Snap Hook	8' (2.4m)



RESCUE KIT

Ready-to-use combinations of North fall protection equipment for rescue, entry/egress and a variety of other applications are intended to simplify equipment selection.

Part #	Content	Description
FP66/415SR	FP2/415SR FP6600/7 FP6610/15 FP6630/7	50' (15 m) 3-Way SRL 7' (2,1 m) Tripod Mount. Bracket Tripod storage Bag



ANCHORAGE TROLLEY ROLLER

Beam trolley that mounts anywhere on a suitable beam with a minimum turn radius of 12" (30mm). Fits widths of 2.3" (50mm) to 6.5" (165mm).

Part #	Description
FP05	Beam trolley roller
FP05EXT	Extension belt for beam trolley roller from 4-1/2" to 8-2/3"
FP06	Gliding beam anchor - Fits 4" to 12"



ROPE GRABS

All North rope grabs are CSA approved and are provided with an orientation lock mechanism. This mechanism prevents the user from installing the rope grab on the rope in the wrong orientation. This orientation lock out is a mandatory requirement for any rope grab that is CSA approved.

Part #	Description
FP541	Automatic rope grab with panic lock to use on 5/8" (16 mm) diameter rope
FP542	Same as FP541 with 2' (0.6 m) Soft Pak energy absorbing lanyard with snap hook
FP561	Easy-open automatic rope grab with parking feature to use on 5/8" (16 mm) and 3/4" (20 mm) diameter rope
FP562	FP561 with 6" (150 mm) lanyard and carabiner to use on 5/8" (16 mm) and 3/4" (20 mm) diameter rope



ROOFER'S KITS

North's roofer's kits set up in minutes for an easy-to-use fall protection solution. The kits include: lightweight universal harness, 3-strand co-polymer rope lifeline 5/8" (16mm), 2 carabiners, CSA approved panic rope grab, 2 roof brackets, 4" (100mm) Ardox spiral nails and a carry bag.

Part #	Description
FP90/25	Kit with 25' (8m) of rope lifeline
FP90/50	Kit with 50' (15m) of rope lifeline



VERTICAL LIFELINES

5/8" (16 mm) 3-strand, with one eye termination end.

Part #	Description	Length
FP16E/SP50	Polyolefin fiber	50' (15m)
FP16E/SP100	Polyolefin fiber	110' (33m)



8 inch COM-PAX-IAL Blower with Canister-15'-25'

This versatile system features the 8" COM-PAX-IAL blower with canister and your choice of 15' or 25' ducting. This lightweight unit is designed with the quick-connect clipping system which allows workers to attach the canister, tools-free, to the input side for powerful extraction or output side for ventilation. The 15' or 25' ducting stores conveniently within the canister. Special design features include blower and canister built-in carry handles, built-in On/Off switch and "Safety" orange coloration.

AC MODELS

Free Air	One 90° Bend	Two 90° Bends
831 CFM	709 CFM 1/3 hp	586 CFM 3A/115v

- Part No. 9533-15** 8" AC COM-PAX-IAL Plastic Blower with canister and 15' ducting - 33 lbs.
- Part No. 9533-25** 8" AC COM-PAX-IAL Plastic Blower with canister and 25' ducting - 38 lbs.



Manhole Guard Rail

Designed to protect an area 33" x 33", this 42" high guard rail collapses to only 44" square x 4" for easy storage. Weighing 34 lbs., the strong, one inch tubular .078 gauge steel construction is powder-coated in safety yellow for a durable finish and high visibility. Simple one-piece construction offers easy, no-tools assembly. Rail locks open and two hooking chains provide protected entry and exit. For safety, the rail accommodates signs, flags or lights, and for convenience, it can be used with a guard rail tent, umbrellas or winch.

Part No. 9401

Guard Rail Winch



Raising and lowering equipment into confined space can be impossible without this durable winch. Even with a 300 lb. capacity, it is lightweight and portable, allowing easy mounting on guard rails. The side pieces are constructed of high tensile, heavy gauge aluminum with a durable yellow finish that resists weather and wear. The winch bar is constructed of rugged high tensile steel tubing with a 3" drum for fast recovery. Two independent ratchet systems, and a double-disc automatic brake offer load control and security. The 1/2" x 35' Dura-Plex™ braided rope is strong and durable. Guard rail not included. *WARNING: Not for use as a personal retrieval device.*

Part No. 9401-10 Guard Rail Winch

Part No. 9401-36 35' Winch Rope

BARRICADE TAPE

Polyethylene barricade tape. 3" x 1,000 feet roll in a handy dispenser box.

Part #	Description	Color
CT3YE1	Caution - Caution	Yellow
CT3YE2	Caution - Do Not Enter	Yellow
CT3RE9	Danger - Danger	Red
CT3RE8	Danger - Do Not Enter	Red
CT3YE7	Danger - Danger	Yellow
CT3YE57	Danger - Authorized Entry Only	Yellow
CT3YE6	Danger - Do Not Enter	Yellow
CT3YE3	Police Line - Do Not Cross	Yellow
CT3YE4	Fire Line - Do Not Cross	Yellow
CT3RE4	Fire Line - Do Not Cross	Red
CT3YE21	Caution - Construction Area	Yellow
CT3YE15	Caution - Men Working Overhead	Yellow
CT3YE13	Caution - Hazard	Yellow
CT3YE5	Caution - Buried Cable	Yellow
CT3YE10	Black Diagonal Line	Yellow
CT3YE16	Asbestos Hazard	Yellow
CT3YE17	Open Trench	Yellow
CT3RE14	H2S - Poisonous Gas	Red
CT3TWP	Barricade Tape Dispenser	—

POLYETHYLENE TAPE
IN A DISPENSER BOX



COTTON TAPE
ON A ROLL

CT3TWP

WARNING TAPE



AS752/3BY

PVC warning tapes has bright, durable printed stripes, or checkboard pattern, protected by laminated clear film. 3" x 18 yards.

AS750/3BY

Part #	Description
AS750/3BY	Yellow with black stripes
AS752/3BY	Yellow with black checkboard pattern



WET FLOOR STAND

Part #	Packaging
TRA030	Floor stand, 12" x 22" (31 cm x 56 cm), styrene .080

Re-pulpable cotton barricade tape, fully biodegradable. 3" x 150 feet roll.

Part #	Description	Color
CT3RE9C	Danger (Cotton barricade tape)	Red
CT3YE1C	Caution (Cotton barricade tape)	Yellow

SURVEYOR'S TAPE



PVC tape to highlight items such as property markers, trees, dangerous items or areas to avoid.

Part #	Packaging
AS77103	12 rolls per box

Traffic Signs

Signs and Accessories

NORTH



24"x24" (610x610) PA10



12"x18" (300x460) P10P



12"x24" (300x610) PA20A



30"x30"x30" (760x760x760) PA20



24"x24" (610x610) PA40

The following signs are all reflective engineer grade and mounted on .064 aluminum backing.



24"x12" (300x610) PA40P



36"x12" (910x300)

PA80/1



24"x24" (610x610) PA130/6



24"x24" (610x610) PA160



12"x18" (300x460) PA150/3



12"x18" (300x460) PA160/1G



12"x18" (300x460) PA150/7G



18"x18" (460x460) PA500/1D



18"x18" (460x460) PA500/1G



18"x18" (460x460) PA500/2D



18"x18" (460x460) PA500/2G



24"x24" (610x610) PA130/1



24"x24" (610x610) PA150



12"x18" (300x460) PA150/2GD



12"x18" (300x460) PA160/1D



12"x18" (300x460) PA150/7D



24"x30" (610x760) PA70/2



12"x18" (460x300) PA500/3G

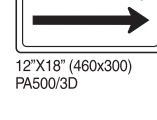

12"x18" (460x300) PA500/3D



12"x36" (300x910) D290/G

12"x36" (300x910) D290/D



24"x24" (610x610) PA130/4



24"x24" (610x610) PA110/5



12"x18" (300x460) PA150/2G



12"x18" (300x460) PA160/1GD



12"x18" (300x460) PA150/7GD

U-Channel Post

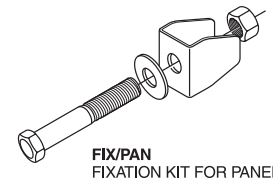
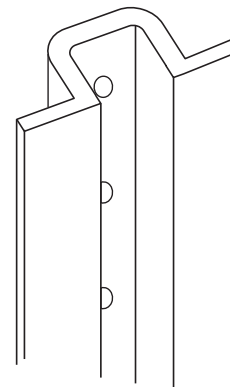

- POT96 U-CHANNEL POST 96" (2m44)
- POT120 U-CHANNEL POST 120" (3m05)
- POT144 U-CHANNEL POST 144" (3m66)

- EXT36 U-CHANNEL POST EXTENSION 36" (910mm)
- EXT48 U-CHANNEL POST EXTENSION 48" (1m22)

FIX/EXT FIXATION KIT FOR EXTENSION

Heat galvanised metal post perforated on its length.

Slow Moving Vehicle



18" x 18" x 18" (460x460x460)

The SMV is printed in two colours: fluorescent yellow orange with a reflective red border.

- TTR006 - GALVANIZED STEEL
- TTR007 - SELF-ADHESIVE VINYL
- TTR008 - RIGID PLASTIC



12"x18" (300x460) PA150/3A



12"x18" (300x460) PA157



12"x18" (300x460) PA159



12"x24" (300x610) PA150/3B



12"x24" (300x610) PA158



12"x24" (300x610) PA164GD



12"x24" (300x610) PA164D



12"x24" (300x610) PA164G

Traffic Signs

Placarding Accessories

Placard Holder

Dangerous goods identification placard holders

Made of light, weather-resistant aluminum. This holder allows quick and easy changing of the identification placards for the various products carried in a vehicle.

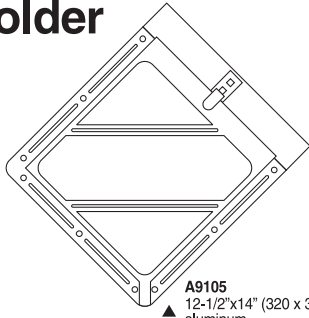

A9105
12-1/2"x14" (320 x 355mm)
aluminum

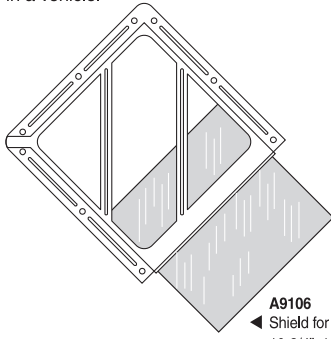

A9106
Shield for placard holder
10-3/4"x10-3/4" (270 x 270mm)
copolyester .020 PKG/10



A9108
UN 1202 - UN1203
DRIVE SAFELY

A9107
UN 1202 - UN1203

Pressure Sensitive Numbering Kit

ADHESIVE NUMBERING KIT 4"X2" (100x50mm) CLEAR POLYESTER - NUMBER HEIGHT: 3-1/2" (90mm)	
PKG OF 600	INCLUDES 100 #0, 100 #1 AND 50 OF EACH OTHER NUMBER PN010
PKG OF 10	EACH PACKAGE INCLUDES 10 OF SAME NUMBER PN020
SPECIFY NUMBER	

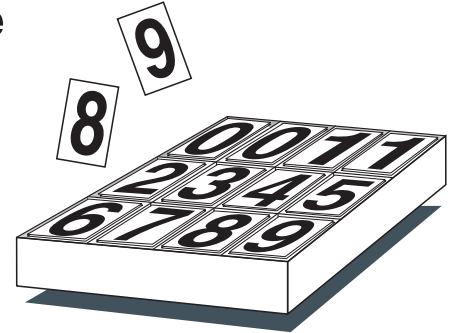

Custom Pin Strips



PN022
CUSTOM PIN NUMBER

STRIPS COME IN CLEAR POLYESTER 4"X8" (100x200mm)
EACH PACKAGE INCLUDES 10 STRIPS OF SAME NUMBER

HOW TO ORDER:

SPECIFY # ITEM AND PIN NUMBER
EXAMPLE: PN022/1005

Tank and Truck Marking (retro-reflective)

KIT NUMBER	PN023	PN025	PN026	PN027
	KIT #1	KIT #2	KIT #3	KIT #4
TRAILER SIZE	ALL SIZES	53-57 FT (16m15-17m37)	45-48 FT (13m72-14m63)	UP TO 28 FT (8m53)
2"X75 FT (50mm x 23m)	1 ROLL			
2"X18" (50mm x 460mm)		36 STRIPS	32 STRIPS	19 STRIPS
2"X12" (50mm x 300mm)	4 STRIPS	4 STRIPS	4 STRIPS	4 STRIPS
2"X90" (50mm x 2.25m)		1 STRIP	1 STRIP	1 STRIP
1-1/2"X90" (38mm x 2.25m)		1 STRIP	1 STRIP	1 STRIP

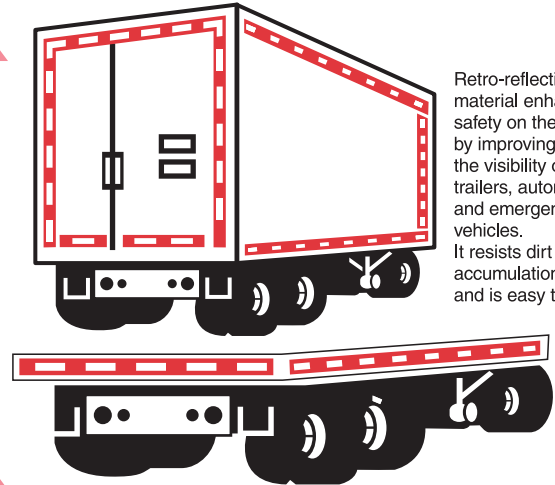

Retro-reflective material enhances safety on the roadway by improving the visibility of trucks, trailers, automobiles and emergency vehicles. It resists dirt accumulation and is easy to apply.

Safety Signs for Tank and Truck

<p>FLAMMABLE</p> <p>PN050 6"X21" (150x530mm) SELF-ADHESIVE VINYL SELF-ADHESIVE REFLECTIVE</p>	<p>NO SMOKING</p> <p>PN051 6"X21" (150x530mm) SELF-ADHESIVE VINYL SELF-ADHESIVE REFLECTIVE</p>	<p>GASOLINE</p> <p>PN052 6"X21" (150x530mm) SELF-ADHESIVE VINYL SELF-ADHESIVE REFLECTIVE</p>	<p>FIRE EXTINGUISHER</p> <p>PN062 8"X12" (200x305mm) SELF-ADHESIVE VINYL SELF-ADHESIVE REFLECTIVE</p>
<p>PROPANE</p> <p>PN053 6"X21" (150x530mm) SELF-ADHESIVE VINYL SELF-ADHESIVE REFLECTIVE</p>	<p>CORROSIVE</p> <p>PN054 6"X21" (150x530mm) SELF-ADHESIVE VINYL SELF-ADHESIVE REFLECTIVE</p>	<p>CAUTION THIS VEHICLE MAKES WIDE RIGHT TURN</p> <p>PN055 6"X21" (150x530mm) SELF-ADHESIVE VINYL SELF-ADHESIVE REFLECTIVE</p>	
<p>DIESEL FUEL</p> <p>PN056 6"X21" (150x530mm) SELF-ADHESIVE VINYL SELF-ADHESIVE REFLECTIVE</p>	<p>NITROGEN</p> <p>PN057 6"X21" (150x530mm) SELF-ADHESIVE VINYL SELF-ADHESIVE REFLECTIVE</p>	<p>CAUTION THIS VEHICLE STOPS AT ALL RAILWAY CROSSING</p> <p>PN058 6"X21" (150x530mm) SELF-ADHESIVE VINYL SELF-ADHESIVE REFLECTIVE</p>	
<p>COMBUSTIBLE</p> <p>PN059 6"X21" (150x530mm) SELF-ADHESIVE VINYL SELF-ADHESIVE REFLECTIVE</p>	<p>COMPRESSED GAS</p> <p>PN060 6"X21" (150x530mm) SELF-ADHESIVE VINYL SELF-ADHESIVE REFLECTIVE</p>	<p>CAUTION THIS VEHICLE MAKES FREQUENT STOPS</p> <p>PN061 6"X21" (150x530mm) SELF-ADHESIVE VINYL SELF-ADHESIVE REFLECTIVE</p>	

<p>CAUTION! THIS VEHICLE MAKES WIDE RIGHT TURNS</p> <p>PN063 16"X14" (410x355mm) SELF-ADHESIVE VINYL SELF-ADHESIVE REFLECTIVE</p>	<p>CAUTION! THIS VEHICLE MAKES WIDE RIGHT TURNS</p> <p>PN064 16"X14" (410x355mm) SELF-ADHESIVE VINYL SELF-ADHESIVE REFLECTIVE</p>	<p>PASSING SIDE</p> <p>PN065 16"X14" (410x355mm) SELF-ADHESIVE VINYL SELF-ADHESIVE REFLECTIVE</p>
---	---	---

<p>TTR001 ENG. GRADE 12" x 96" 12" x 96" (305mmX2.44m)</p>	<p>TTR002 ENG. GRADE 18" x 96" 18" x 96" (460mmX2.44m)</p>	<p>TTR004 PVC (roll-up) 12" x 96" (305mmX2.44m)</p>
---	---	--

HOW TO ORDER:

SPECIFY # ITEM AND MATERIAL
EXAMPLE: PN055VY (VY=SELF-ADHESIVE VINYL)
PN055RFL (RFL= SELF-ADHESIVE REFLECTIVE)



ESA015

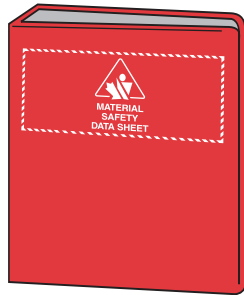

ESA017

Part #	Description
ESA015	18" x 24" styrene station (binder not included)
ESA017	Binder for WHMIS station

WHMIS WORKPLACE HAZARDOUS MATERIAL INFORMATION

WHMIS HAZARD SYMBOLS

CLASS

A COMPRESSED GASES

B FLAMMABLE GASES
FLAMMABLE LIQUIDS
FLAMMABLE SOLIDS

C OXIDIZING MATERIAL

D CORROSIVE MATERIAL

E CORROSIVE MATERIAL

F DANGEROUSLY REACTIVE MATERIAL

MATERIAL SAFETY DATA SHEET

MUST CONTAIN

- NAME OF PRODUCT
- PRECAUTIONARY MEASURES TO TAKE:
 - WHILE USING THE PRODUCT
 - WHILE HANDLING THE PRODUCT
 - IN CASE OF EXPOSURE TO THE PRODUCT
- REFERENCE TO SAFETY DATA SHEET

NINE CATEGORIES WHICH MUST APPEAR ON IDENTIFICATION SHEET

- 1- PRODUCT INFORMATION
- 2- DANGEROUS COMPONENTS
- 3- PHYSICAL PROPERTIES
- 4- RISKS OF EXPOSURE TO OPEN FLAME
- 5- INFORMATION ON CHEMICAL REACTION
- 6- TOXICOLOGICAL PROPERTIES
- 7- PRECAUTIONARY MEASURES
- 8- FIRST AID MEASURES
- 9- INFORMATION CONCERNING IDENTIFICATION SHEET

WHMIS SUPPLIER LABEL

WHMIS WORKPLACE LABEL

MUST INCLUDE

Part #	Description
ESA017A	24" x 18" (610 mm x 457 mm) styrene station

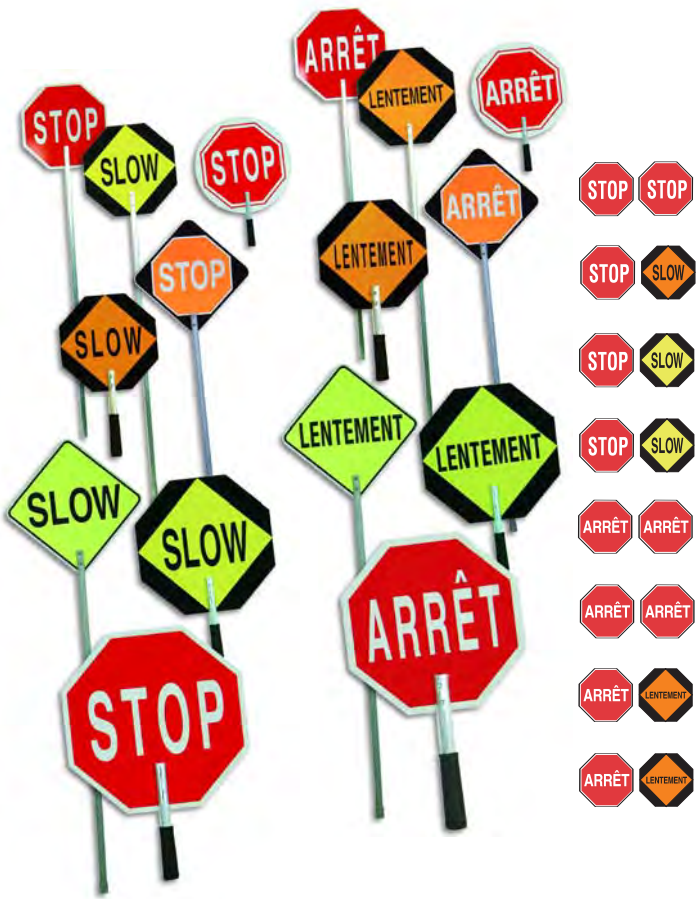

STOP AND SLOW PADDLES

Traffic paddles in plastic, reflective aluminium or reflective plastic.

Part #	Material	Size	Handle / Pole
PTA001P (English)	Styrene .080	12" x 12"	10" aluminium
PTA012ALRF (English)	Reflective aluminium .064	18" x 18"	54" aluminium
PTA015BC (English)	Reflective styrene .080	16" x 16"	10" aluminium
PTA012ONT (English)	Reflective aluminium .080 Meets Ontario regulations	18" x 18"	60" PVC
PTF011P (French)	Styrene .080 Meets Quebec regulations	18" x 18"	54" aluminium
PTF011ALRF (French)	Reflective aluminium .064 Meets Quebec regulations	18" x 18"	54" aluminium
PTF012P (French)	Styrene .080 Meets Quebec regulations	18" x 18"	54" aluminium
PTF012ALRF (French)	Reflective aluminium .064 Meets Quebec regulations	18" x 18"	54" aluminium

FIRE ALERT FLAT SIGNS



FAA0053/ST



FAA0005/ST

Directional and fire signs made of Styrene.

Part #	Description	Size
FAA0053/ST	Fire extinguisher	4" x 18" (10 cm x 46 cm)
FAA0005/ST	Fire extinguisher	9" x 12" (23 cm x 31 cm)

FIRE ALERT L-SHAPED SIGNS



FAA0063/ST



FAA0013/ST

Directional and fire signs made of styrene.

Part #	Description	Size
FAA0063/ST	Fire extinguisher	4" x 18" (10 cm x 46 cm)
FAA0013/ST	Fire extinguisher	9" x 12" (23 cm x 31 cm)

FIRE ALERT V-SHAPED SIGNS



FAA0073/ST



FAA0021/ST

Directional and fire signs made of styrene.

Part #	Description	Size
FAA0073/ST	Fire extinguisher	4" x 18" (10 cm x 46 cm)
FAA0021/ST	Fire extinguisher	9" x 12" (23 cm x 31 cm)

DO NOT OPERATE PREVENTION TAG



Do Not Operate Tags, styrene .020, no Grommet.

Part #	Description	Package
ELA290/1	Lockout Tag "Do not operate"	25 per pk

ACCIDENT PREVENTION TAGS

FRONT



EEA010G/A

BACK



EEA303G

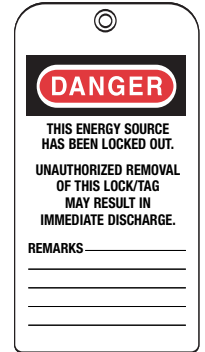

Accident prevention tags made of styrene .020, 3" x 5-3/4" with 3/8" grommets.

Part #	Description	Package
EEA010G/A	Lockout Tag "Do not operate"	25 per pk
EEA303G	Photo Lockout Tag "Do not operate"	25 per pk

Accident Prevention Tags

NORTH SAFETY PRODUCTS manufactures for your needs these 3" x 5-3/4" (75x145mm) tags made of rugged stain and mildew resistant styrene, tyvek and teslin-polyester for lockout tags (see page 33). Their textured surface allows you to write down important information such as times and dates, authorized signatures and any other instructions.

They are sold in packs of 25 identical tags with fasteners. These tags are also available with grommets 3/8" (9.5mm).

						<p>Choose the type of reverse side better suited to your needs.</p> <p>To order, all you need to do is to add the letter of the reverse side of your choice to the tag number. For instance, if you require tag number EEA025 with reverse side type B, ask for item number EEA025B.</p> <div style="display: flex; justify-content: space-around;"> <div style="border: 1px solid black; padding: 5px; width: 45%;"> <p style="text-align: center;">DANGER</p> <p style="text-align: center;">DO NOT REMOVE THIS TAG</p> <p>REMARKS: _____</p> <p>_____</p> <p>_____</p> <p style="text-align: center;">SEE OTHER SIDE</p> <p style="text-align: center;">TYPE A</p> </div> <div style="border: 1px solid black; padding: 5px; width: 45%;"> <p style="text-align: center;">DANGER</p> <p style="text-align: center;">DO NOT REMOVE THIS TAG</p> <p style="text-align: center;">TO DO SO WITHOUT PROPER AUTHORITY WILL MEAN IMMEDIATE DISCHARGE THIS TAG IS HERE FOR A PURPOSE</p> <p style="text-align: center;">SEE OTHER SIDE</p> <p style="text-align: center;">TYPE B</p> </div> </div>													
					<p style="text-align: center;">HOW TO ORDER</p> <p>IF YOU NEED GROMMETS ADD THE LETTER G AFTER TAG NUMBER AND ADD THE REVERSE SIDE A OR B</p> <p>EXAMPLE WITH REVERSE SIDE B</p> <p>EEA010 B (REGULAR - STYRENE)</p> <p>EEA010G B (STYRENE WITH GROMMET) (FOR GROMMETS ADD LETTER G TO MODEL NUMBER)</p> <p>EEA010TV B (TV=TYVEK)</p> <p>EEA010GTV B (TYVEK WITH GROMMETS)</p>														

* Available with reverse side type A only
 ** Tags with identical back

Safety Signs



As per CSA Canadian Standards

REGULATORY SIGNS

Regulatory signs shall be:

1.1- The **prohibition** sign, which denotes an order forbidding an action.

This sign shall have a dark grey background on which is located center top the red, black and white symbol sign surrounded by a white margin with text in white below.

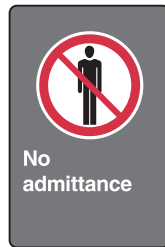

A0003/12
PC-PA-PM 3-4
VY 1-2-3

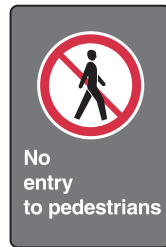

A0007/12
PC-PA-PM 3-4



A0187/12
PC-PA-PM 3-4



A0191/12
PC-PA-PM 3-4



A0205/12
PC-PA-PM 3-4

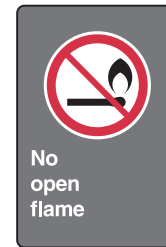

A0439/12
PC-PA-PM 3-4



A0537/12
PC-PA-PM 3-4-5
VY 1-2-3



A0603/12
PC-PA-PM 3-4-5

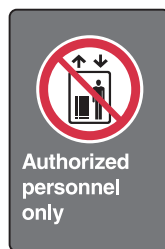

A0619/12
PC-PA-PM 3-4



A0541/12
PC-PA-PM 3-4



A0043/12
PC-PA-PM 3-4



A0071/12
PC-PA-PM 3-4



A0507/12
PC-PA-PM 3-4

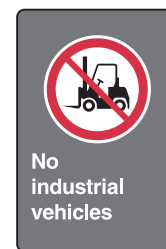

A0565/12
PC-PA-PM 3-4-5

REGULATORY SIGNS

Regulatory signs shall be:

1.2- The **mandatory** sign, which denotes an order requiring an action.

This sign shall have a dark grey background on which is located center top the black and white symbol sign surrounded by a white margin, with text in white below.



A0233/13
PC-PA-PM 3-4-5



A0585/13
PC-PA-PM 3-4-5
VY 1-2-3



A0237/13
PC-PA-PM 3-4-5



A0583/13
PC-PA-PM 3-4-5



A0883/13
PC-PA-PM 3-4-5



A0589/13
PC-PA-PM 3-4-5

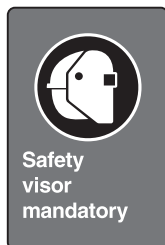

A0881/13
PC-PA-PM 3-4-5



A0447/13
PC-PA-PM 3-4-5



A0257/13
PC-PA-PM 3-4-5



A0195/13
PC-PA-PM 3-4-5



A0653/13
PC-PA-PM 3-4-5



A0715/13
PC-PA-PM 3-4-5



A0709/13
PC-PA-PM 3-4-5



A0053/13
PC-PA-PM 3-4-5



A0823/13
PC-PA-PM 3-4-5



A0471/13
PC-PA-PM 3-4-5

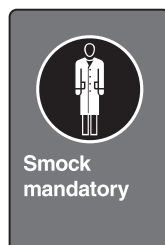

A0743/13
PC-PA-PM 3-4-5



A0437/13
PC-PA-PM 3-4-5



A0467/13
PC-PA-PM 3-4-5



A0705/13
PC-PA-PM 3-4-5

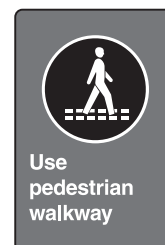

A0867/13
PC-PA-PM 3-4-5

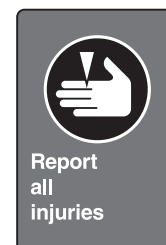

A0753/13
PC-PA-PM 3-4-5















SAFETY SIGNS AS PER CSA STANDARDS

Safety signs made of styrene .060, 8" x 12" (20 cm x 31 cm).

 No admittance A0003/12/4PC	 No food or drinks allowed A0043/12/4PC	 No smoking A0537/12/4PC	 Caution industrial vehicles traffic A0101/21/4PC	 Danger of electrocution A0291/22/4PC	 Danger flammable materials A0333/22/4PC	 Women A0841/34/4PC	 Men A0843/34/4PC	 Eye wash fountain A0383/32/4PC
 Fire extinguisher A0423/31/4PC	 Gathering point A0631/32/4PC	 First aid kit A0853/32/4PC	 Safety helmet mandatory A0233/13/4PC	 Safety glasses mandatory A0585/13/4PC	 Gloves mandatory A0447/13/4PC	 Safety footwear mandatory A0257/13/4PC	 Hearing protectors mandatory A0653/13/4PC	 Respirator mandatory A0715/13/4PC

SAFETY SIGNS AS PER OSHA STANDARDS

Safety signs made of styrene .030, 10" x 14" (25 cm x 36 cm).

 CAUTION EAR PROTECTION REQUIRED IN THIS AREA CA0069/3ST	 CAUTION FOOT PROTECTION REQUIRED IN THIS AREA CA0105/3ST	 CAUTION GLOVES REQUIRED IN THIS AREA CA0109/3ST	 CAUTION HARD HATS REQUIRED IN THIS AREA CA0119/3ST	 CAUTION PERSONAL PROTECTIVE EQUIPMENT REQUIRED IN THIS AREA CA0193/3ST	 CAUTION RESPIRATORS REQUIRED IN THIS AREA CA0215/3ST	 CAUTION SAFETY GLASSES REQUIRED IN THIS AREA CA0223/3ST	 CAUTION SLIPPERY WHEN WET CA0233/3ST
 CAUTION SAFETY HARNESS REQUIRED CA0307/3ST	 NOTICE AUTHORIZED PERSONNEL ONLY NA0013/3ST	 NOTICE NO PARKING NA0125/3ST	 NOTICE NO TRESPASSING NA0131/3ST	 DANGER CONFINED SPACE ENTER BY PERMIT ONLY DA0068/3ST	 DANGER DO NOT ENTER DA0099/3ST	 DANGER EAR PROTECTION REQUIRED IN THIS AREA DA0135/3ST	 DANGER EXPLOSIVES DA0149/3ST
 DANGER EYE PROTECTION AREA DA0157/3ST	 DANGER FLAMMABLE DA0163/3ST	 DANGER H2S POISONOUS GAS DA0195/3ST	 DANGER HARD HATS ARE REQUIRED IN THIS AREA DA0205/3ST	 DANGER HAZARDOUS CHEMICALS DA0209/3ST	 DANGER HIGH PRESSURE LINE DA0218/3ST	 DANGER HIGH VOLTAGE DA0221/3ST	 DANGER KEEP OUT DA0261/3ST
 DANGER LOCKOUT EQUIPMENT BEFORE REPAIRS DA0290/3ST	 DANGER NO SMOKING DA0323/3ST	 DANGER NO TRESPASSING DA0343/3ST	 DANGER OPEN HOLE DA0349/3ST	 DANGER OPEN PIT DA0351/3ST	 DANGER SAFETY SHOES REQUIRED IN THIS AREA DA0377/3ST	 DANGER THIS EQUIPMENT STARTS AUTOMATICALLY DA0393/3ST	
 SAFETY FIRST FIRST AID ROOM SA0026/3ST	 SAFETY FIRST EYE WASH STATION SA0028/3ST	 SAFETY FIRST FIRST AID KIT SA0029/3ST	 SAFETY FIRST FIRST AID STATION SA0033/3ST	 SAFETY FIRST STRETCHER HERE SA0060/3ST			

SAFETY FENCE AND SNOW FENCE

STEEL "T" POST

6' - 7' - 8'

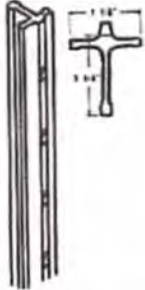

- * TRADITIONAL CHAIN LINK DESIGN
- * 2" MESH OPENING
- * 4 FT. X 50 FT. ROLLS
- * WEIGHT - 7.7 KGS.

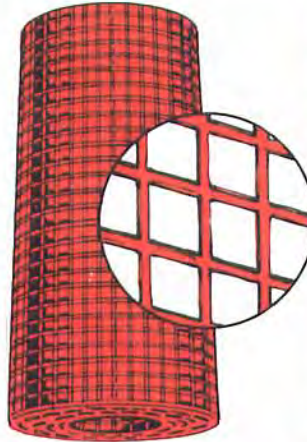

- * 1-7/8" SQUARE MESH OPENING
- * FINISHED EDGE TOP AND BOTTOM
- * EASY TO INSTALL
- * 4 FT. X 50 FT. ROLLS AND 4 FT. X 100 FT.
- * WEIGHT - 8 KGS. AND 16 KGS.

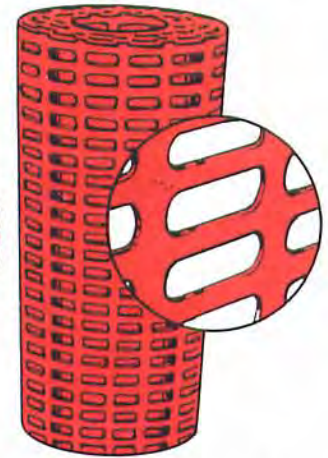

- * 1-7/8" SQUARE MESH OPENING
- * FINISHED EDGE TOP AND BOTTOM
- * EASY TO INSTALL
- * 4 FT. X 50 FT. ROLLS AND 4 FT. X 100 FT.
- * WEIGHT - 8 KGS. AND 16 KGS.

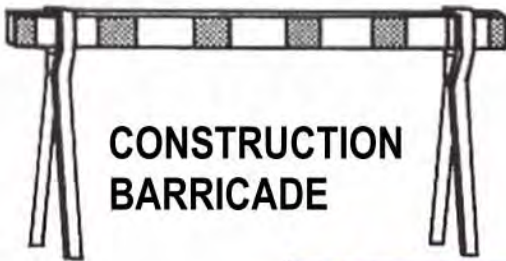

CONSTRUCTION BARRICADE



" MEN AT WORK " SIGNS



BARRICADE FLASHERS



LIFE RINGS
Canadian Coast Guard approved
24" White
24" - 30" Orange



GAFF

REVOLVING LIGHTS



Model 550



Model 550M



FALCON HAND HELD HORN

EMERGENCY SECURITY LIGHT

Goes on automatically when the power goes off. Keep in an accessible place or permanently wall mount. Stays on up to 3 hrs. 6 amps. 120 volts. Colour: White.





PORTABLE EXTINGUISHERS



Features

- Simple Seize & Squeeze operation
- Highly visible, easy to read pressure gauge
- Non-conductive
- Pyrene Quality Powder contains a high percentage of Monoammonium Phosphate for superior fire knock down capabilities
- Suitable for A, B, C fires; not suitable for Class D fires (metal fires)
- Aluminum or Steel cylinder with a weather resistant, baked polyester, enamel finish
- Cylinders 100% Pressure Tested
- Long-life metal valve
- Critical components designed to last
- Easy-to-follow pictorial instructions
- Discharge hose will not conduct electricity for operator safety
- Designed for safe operation fingers can't get trapped
- Operable at temperatures from -40 to +120F, permitting use under adverse conditions
- 5 year warranty

SPECIFICATIONS ABC EXTINGUISHERS

Product #	Model #	U.L.C. Rating	Discharge			Diameter		Width		Height		Weight		Bracket	Cylinder Type	Master Package	Powder Volume (lb)
			Meters	Feet	Time(sec)	Cm	Inches	Cm	Inches	Cm	Inches	Kg	lbs				
70385	P110ABC	1A,10BC	3.6	12	8.5-10.5	8.38	3.3	13.46	5.3	38.1	15	1.8	4	W/B	ALUM.	6	2.6
70384	P110ABC-VB	1A,10BC	3.6	12	8.5-10.5	8.38	3.3	13.46	5.3	38.1	15	1.8	4	V/B	ALUM.	6	2.6
23179	5MB-9HC	3A,40B:C	3.7	12	14	10.0	4.25	18.41	7.25	38.7	15.25	2.27	10	W/B	STEEL	10	5
23184	5MB-9HBC	3A,40B:C	3.7	12	14	10.8	4.25	18.41	7.25	38.7	15.25	2.27	10	V/B	STEEL	10	5
70606	P340BC	3A,40BC	3.6	12	13-15	11.43	4.5	19.81	7.8	40.6	16	3.6	8	W/B	ALUM.	4	5
70358	P340ABC-VB	3A,40BC	3.6	12	13-15	11.43	4.5	19.81	7.8	40.6	16	3.6	8	V/B	ALUM.	4	5
70607	P460ABC	4A,60BC	6	20	17-21	12.95	5.1	18.79	7.4	53.8	21.2	8.6	19	W/B	STEEL	1	10
70609	P1080ABC	10A,80BC	6	20	20-24	17.78	7	22.35	8.8	55.8	22	14.9	33	V/B	STEEL	1	20

Quadra Flex V Kits

- Spring-loaded QFV sign stands display 36" and 48" roll-up panels a minimum of 14" off the ground
- Patented spring design incorporates anti-rotational device and positive stops to prevent spring over-stress
- Exclusive base, spring and leg design eliminates the need for sandbags and absorbs winds up to 50 mph
- Unique kick lock release lever allows easy leg unfolding and adjusting to uneven terrain
- Durable, lightweight and corrosion-resistant aluminum legs provide longer service life and easier handling without sacrificing strength
- Quick lock mast allows for easy panel set-up/take-down. Velcro strap-on mast prevents panel from windmilling when wrapped around vertical fiberglass rib
- Four steel L-shaped brackets reinforce legs to base. Telescoping aluminum legs provide maximum stability
- Kits include: Base, Mast, Ribs and Flags



- 3007536, QUADRA FLEX V™ KIT FOR 36" SIGN , (2083673)
- 3006686, QUADRA FLEX V™ BASE , (119045)
- 3006172, QUADRA FLEX V™ BASE & MAST FOR 48" ROLL-UP SIGN , (101490)
- 3006174, QUADRA FLEX V™ BASE & TELESCOPING MAST , (101517)
- 3006173, QUADRA FLEX V™ 60 (BASE & MAST ONLY) , (101505)
- 3006184, QUADRA FLEX V™ MAST FOR 36" ROLL-UP SIGN , (101763)
- 3006185, QUADRA FLEX V™ MAST FOR 48" ROLL-UP SIGN , (101775)
- 3006186, QUADRA FLEX V™ TELESCOPING MAST , (101787)
- 3007381, ADAPTER FOR RIGID AND SEMI-RIGID SIGNS , (2059665)

DW Series Cones

- Meets MUTCD standards
- Wide body design with rugged black base
- Flow molded, dayglow orange PVC w/white inner liner
- Custom stenciling available
- Made In The USA



- 3004101, DW CONE – 6" [1.5 LBS] , (100680)
- 3004020, DW CONE – 12" [1.5 LBS] , (100032)
- 3004023, DW CONE – 18" [3 LBS] , (100109)
- 3004319, DW CONE – 18" WITH 6" COLLAR, 3M [3 LBS] , (2215283)
- 3004057, DW CONE – 28" [7 LBS] , (100355)
- 3004236, DW CONE – 28" [7 LBS] WITH 4" & 6" COLLARS, 3M , (2193643)
- 3004059, DW CONE – 28" [7 LBS] FLAGTOP , (100408)
- 3004176, DW CONE – 28" [10 LBS] , (2058647)
- 3004254, DW CONE – 28" [10 LBS] WITH 4" & 6" COLLARS , (2202341)
- 3004256, DW CONE – 28" [10 LBS] WITH 4" & 6" COLLARS, 3M , (2202353)
- 3004205, DW CONE - 28" , WITH 4" & 6" COLLARS, AVERY
- 3004159, DW CONE – 36" [10 LBS] , (2058116)
- 3004231, DW CONE – 36" [10 LBS] WITH 4" & 6" COLLARS, 3M , (2193631)
- 3004226, DW CONE – 36" [12 LBS] , (2089926)

Speed Bump

- Will not warp, crack, chip or rot
- Withstands 120,000 lbs
- Yellow polyurethane glass-beaded paint for maximum reflectivity
- Channeled bottom (two 11/4" channels) allows for cabling or piping and facilitates drainage
- Three spikes required on 48", four spikes on 72" speed bumps. Spikes sold separately
- Made of 100% recycled rubber
- Standard package



items available:

- 3007916, STRIPED SPEED BUMP 2.5" X 12" X 48" (34 LBS.) , (2185050)
- 3007917, STRIPED SPEED BUMP 2.5" X 12" X 72" (51 LBS.) , (2185074)
- 3007973, 14" REBAR SPIKE , (2192326)

Parking Curb

- Will not warp, crack, chip or rot
- 1/10 the weight of concrete
- Yellow polyurethane glass-beaded paint for maximum reflectivity
- Resistant to UV, moisture, oil and extreme temperature variations
- Two spikes required on 36", four spikes on 72" parking curbs. Spikes sold separately
- Made of 100% recycled rubber
- Standard package



items available:

- 3007914, PARKING CURB 4" X 6" X 36" (17 LBS.) , (2185024)
- 3007915, PARKING CURB 4" X 6" X 72" (34 LBS.) , (2185036)
- 3007973, 14" REBAR SPIKE , (2192326)

TRAFFIC CONES



TRAFFIC CONES

Part #	Description	Weight
1616/183C3NL	18" Orange recycled plastic with 3" collar	1385g (3 lb)
1617/183C3NL	18" Orange LDPE with 3" collar	1385g (3 lb)
1616/285C4NL	28" Orange recycled plastic with 4" collar	2300g (5 lb)
1617/287C6NB	28" Orange LDPE with 6" North-Brite™ retro-reflective collar	3200g (7 lb)
1617/287CC64NB	Complete 28" orange LDPE cone with #5 base and 6" top and 4" bottom North-Brite™ collar meets new 2006 standards	3200g (7 lb)
1617/287CC64NL	Complete 28" orange LDPE cone with #5 base and 6" top and 4" bottom North-Lite™ collar meets new 2006 standards	3200g (7 lb)

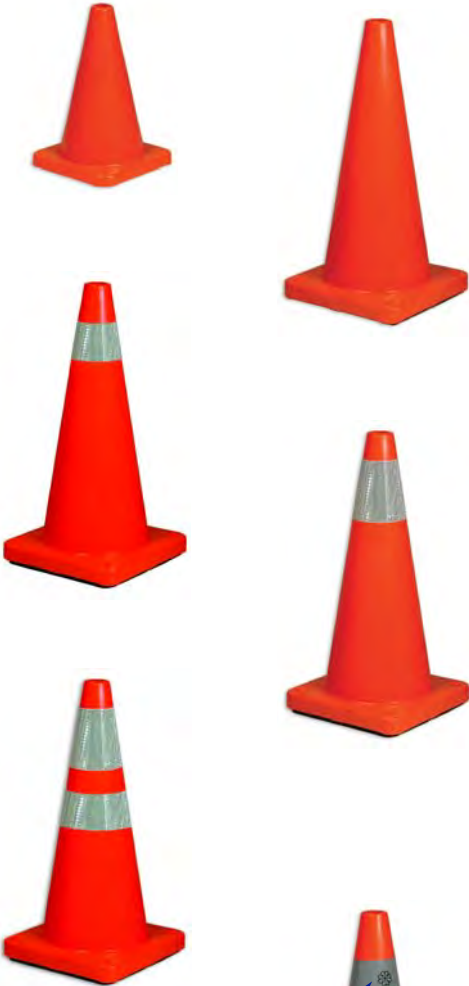

Artwork not included

Printed Cone Collars
Minimum quantity of 50

CONE COLLARS



Part #	Description
CC4NB	4" white North-Brite™ reflective cone collar, slip-on
CC6NB	6" white North-Brite™ reflective cone collar, slip-on
CC3NL	3" Silver North-Lite™ reflective adhesive cone collar
CC4NL	4" Silver North-Lite™ reflective adhesive cone collar
CC6NL	6" Silver North-Lite™ reflective adhesive cone collar
CC6/4NL	Two Cone Collars - North-Lite™ reflective adhesive material 6" top and 4" bottom collar meet new 2006 standards
CC6/4NB	Two Cone Collars - North-Brite™ reflective adhesive material 6" top and 4" bottom collar meets new 2006 standards



SAVING MONEY WITH SAFETY NETS



Safety Nets saved time and money on this multi-story job replacing "Boarding Over" for a fraction of the cost and with greater safety.

This is a 12-story building. All structural steel will be quickly placed by a mobile crane, operating at ground level. The decking, however, will go in more slowly, and could delay steel erection.

OSHA regulations call for worker-protection against falls

within two stories of the working level. The Contractor has three choices: "board-over," "tie-off" or use safety nets. If he is smart, he'll provide greater safety for his workers -- and save money doing it --- by using safety nets. Ask us and we'll show you how!



TRUCK NETS



JUTE BAGS
FABRENE BAGS

JUTE IN ROLLS



S.O.S EMERGENCY ROAD FIRST AID KIT

Zippered nylon bag 15 1/2" x 9" x 6", with 2 handles, elastic fittings and compartments. 10 unit Bulk kit.

Part #	Description
FASOS1ESAFE	S.O.S emergency road first aid kit

ROAD HAZARD FIRST AID KIT



Zippered nylon bag 10" x 8" x 3", with 2 handles, plus velcro to adhere to auto trunk carpeting. Opens like a book, and opens again. Separate see-through pockets, elastic fittings and foam pad 17" x 8" for splinting (bulk).

Part #	Description
FAP2019S	Road hazard first aid kit

CAR FIRST AID KITS



Part #	Description
FACP	Car first aid kit, plastic
FACM	Car first aid kit, metal

FIRST RESPONDER FIRST AID KITS



Part #	Description
FAKFR5000	First responder kit #5000 - cordura nylon padded bag - 19" x 10" x 12 1/2"
FAKFR6000	First responder kit #6000 - cordura nylon padded bag - 19" x 10" x 12 1/2"

TRUCK FIRST AID KITS



Part #	Description
FA8TRP	Truck first aid kit, plastic (10" x 9" x 3")
FA8TRM	Truck first aid kit, metal (7" x 10" x 3")

INDUSTRIAL FIRST AID KIT



Part #	Description
FA25	Metal box (XF39) 15.5" x 12" x 4.5" for 25 employees or less
FA50	Metal box (XF40) 14.5" x 16.5" x 6.5" for 25 employees or more
FA33	Metal box (XF40) 14.5" x 16.5" x 6.5" for 200 employees

SPORT ACTIVITY FIRST AID KITS



Part #	Description
FAK/GOLF	First aid kit for golfer - cordura/nylon belt pouch
FAK/FORET	First aid kit for hiker - cordura/nylon belt pouch
FAK/SKIMOTO	First aid kit for snowmobiler - cordura/nylon belt pouch
FAFP/JOG	First aid kit for jogger - waterproof nylon waist pouch
FAFP/VELO	First aid kit for cyclist - waterproof nylon waist pouch
FAFP/SKI	First aid kit for skier - waterproof nylon waist pouch



For a complete product offering of North's Provincial First Aid Kits, request our First Aid Products Catalogue (52 pages)

MOISTURE RESISTANT ADHESIVE TAPE ON SPOOL

From



NOW Latex Free

Vinyl cotton tape ideal for protecting wounds and dressings.

Part #	Description
B/1410/B5	1/2" x 5yards (1.3cm x 4.6m)
B/1410/B1	1" x 5yards (2.5cm x 4.6m)



GAUZE PADS (STERILE)

Quality, highly absorbent gauze pads. Individually wrapped, pack of 25.

Part #	Description
GB/1418A2	2" x 2" (5cm x 5cm)
GB/1418A3	3" x 3" (7.6cm x 7.6cm)
GB/1418A4	4" x 4" (10cm x 10cm)

GAUZE BANDAGE ROLLS



Made of finest quality surgical gauze, sterile. Individually wrapped.

Part #	Description
GB/1414A1	1" x 10 yards (2.5cm x 9m)
GB/1414A2	2" x 10 yards (5cm x 9m)
GB/1414A3	3" x 10 yards (7.5cm x 9m)
GB/1414A4	4" x 10 yards (10cm x 9m)

ADHESIVE DRESSING STRIPS



NOW Latex Free

The adhesive dressing strips are now latex free and in box of 100. All are individually wrapped.

Part #	Description
B/1445	Plastic strips 3/4" x 3" (1.9cm x 7.5 cm)
B/1430D	Fabric strips, 3/4" x 3" (1.9cm x 7.5 cm)
B/1433100	Finger-tip dressings, large, IW
B/1434	Finger-tip dressings, small, IW
B/1435	Knuckle bands, IW

Note: Other size are also available

PRESSURE BANDAGE (STERILE)



Made of finest quality surgical gauze. Individually wrapped and sterilized.

Part #	Description
PB/1422/2	2" (5 cm)
PB/1422/3	3" (7.5 cm)
PB/1422/4	4" (10 cm)
PB/1422/6	6" (15 cm)

ELASTIC BANDAGE



A quality elastic bandage at a low price. Machine washable.

Part #	Description
B/1426/2	2" x 5 yards (5 cm x 4.5 cm)
B/1426/3	3" x 5 yards (7.5 cm x 4.5 cm)
B/1426/4	4" x 5 yards (10 cm x 4.5 cm)
B/1426/6	6" x 5 yards (15 cm x 4.5 cm)

**INNOVATIVE FIRST AID
FOR BURN INJURIES**



Part #	Description
Sterile Burn Dressing	
WJ/7201781	2" x 6" (5 cm x 15 cm)
WJ/7201771	4" x 4" (10 cm x 10 cm)
WJ/7201761	4" x 16" (10 cm x 41 cm)
WJ/7201751	8" x 18" (20 cm x 46 cm)
WJ/7201801	12" x 16" (31 cm x 41 cm)
Cool Jel	
WJ/0490701	4 oz squeeze bottle
Fire Blankets	
WJ/0490201	Burn wrap 60" x 72"
WJ/0490401	Heat shield 96" x 72"
Burn Kits	
WJ/LUK36	Utilities, plastic (16 unit)
WJ/LFSK5	Food services, plastic (16 unit)
WJ/LIWK5	Industrial/Welding, plastic (16 unit)



**ERGONOMIC
BACK SUPPORT
BELT**

Part #	Description	Size
EL/896	Back support belt	S to XL

HOT AND COLD THERAPY



Part #	Description
V/1559	Instant cold compress - Kit size
V/1560	Instant cold compress - Large size
V/1561	Instant hot compress - 6" x 9"

EMERGENCY RESCUE SHEET



Retains body heat to protect against shock following an accident, or to keep you warm in sub-zero temperatures.

Part #	Size
EB/1594A	56" x 80" (140cm x 204cm)

**EMERGENCY
RESCUE BLANKETS**



Bright yellow plastic outer covering heat-sealed to cellulose type filter. Suitable for use in emergency vehicle.

Part #	Size
EB/1594	60" x 72" (150cm x 195cm)

EMERGENCY BLANKETS



Part #	Description
EB/1601A	100% wool - 54" x 90" (137cm x 229cm)
EB/1601G	50% wool/50% polyester - 59" x 83" (150cm x 210cm)
EB/1601U	Mixed fiber - 60" x 80" (153cm x 203cm)

**DOUBLE FOLD ARMY POLE
STRETCHER WITH FEET**



Folds neatly in half for space saving storage. Durable rubber hand grips. Size open: 81" x 21-1/2" x 5-1/2" de haut (205.7 cm x 54.61 cm x 13.97 cm).

Part #	Description
ST/108AF	Double fold army pole stretcher with feet

WIRE BASKET STRETCHER



Part #	Description
ST/1597	Rugged protective wire basket only (80-3/4" x 25-1/2" x 7-1/2")
ST/1598	Mattress
ST/1599	Straps

ENVIRONMENT PROTECTION

HYDROPHOBIC SORBENT ROLLS (OIL ONLY)



- Used for large surface of land and marine spill
- Absorbs 25 to 1

Sizes	Capacity
3/8" X 19" X 144'	190 litres
1/4" X 19" X 144'	125 litres
3/16" X 19" X 288'	190 litres
3/8" X 38" X 144'	380 litres
1/4" X 38" X 144'	250 litres
3/16" X 38" X 288'	380 litres



HYDROPHOBIC SORBENT PADS (OIL ONLY)

- 100 / bale
- Absorbs 188 litres / bale
- Size 17" X 19" X 3/8"
- Also available:
17" X 19" X 1/4" (100/bale)
17" X 19" X 3/16" (200/bale)
34" X 38" X 3/8" (50/bale)

UNIVERSAL SORBENT ROLLS (CHEMICAL)

- Used for large land surface or land spill
- Absorbs 25 to 1

Sizes	Capacity
3/8" X 19" X 144'	190 litres
1/4" X 19" X 144'	125 litres
3/16" X 19" X 288'	190 litres
3/8" X 38" X 144'	380 litres
1/4" X 38" X 144'	250 litres
3/16" X 38" X 288'	380 litres



ULTRA 95 SALVAGE DRUM

- 100% polyethylene
- 75 imp. gallons capacity
- U.N. approved
- Packaging group I
- Twist-on lid
- nestable
- also available in 45 and 25 gallons capacity



SORBENT SOCKS

- 3" x 48"
- 40/bale
- For maintenance and prevention
- 02 Q 4048 Hydrophobic
- 02 US 4048 Universal



NESTABLE DRUMS FOR HAZARDOUS WASTE

- 30 gallons capacity
- 100 % polyethylene
- Lever ring closure
- U.N. rated group II

HYDROPHOBIC SORBENT BOOMS (OIL ONLY)



- Absorbs oils and petroleum based spill off land and water
- Keeps floating even when saturated
- 4 / bundle
- Linkable

#	Sizes	Capacity
Q8100	8" X 10'	385 litres
QC8100	8" X 10'	385 litres
Continuous		
Q 5100	5" X 10'	220 litres
QC 5100	5" X 10'	220 litres

Also available in universal

SPILL KITS



CUSTOMIZED KITS ON REQUEST



AKRO-BINS

- Made of heavy-duty polypropylene
- Water, rust and corrosion-proof
- Unaffected by weak acids and alkalis
- Large label slot
- Sits on shelving or use with panels and racks
- Colour: Red, Yellow, Blue

Model	Outside Dimensions W x L x H	Inside Dimensions W x L x H	Qty/ Case	DIVIDERS	
				Lids	Model
30-210	4 1/8 x 5 1/8 x 3"	3 7/16 x 4 1/8 x 2 1/16"	24	30-211	40-210
30-220	4 1/8 x 7 1/8 x 3"	3 7/16 x 6 1/8 x 2 1/16"	24	30-221	40-220
30-230	5 1/2 x 10 1/8 x 5"	4 1/8 x 10 1/8 x 4 1/8"	12	30-231	40-230
30-235	11 x 10 1/8 x 5"	10 x 10 1/8 x 4 1/8"	6	—	40-230
30-239	8 1/8 x 10 1/8 x 7"	6 7/16 x 10 x 6 1/8"	6	—	40-239
30-240	8 1/8 x 14 1/8 x 7"	6 7/16 x 14 x 6 1/8"	12	—	40-245
30-250	16 1/2 x 14 1/8 x 7"	14 1/8 x 14 x 6 1/8"	6	—	40-245
30-265	8 1/8 x 18 x 9"	6 7/8 x 17 1/8 x 8 1/8"	6	—	40-265
30-270	16 1/2 x 18 x 11"	14 1/8 x 17 1/8 x 10 1/8"	3	—	40-270

Colour: Red (0), Blue (1), Yellow (2)



18.9 L. Water cooler
Color : Orange



cup
dispensers



4on. paper cups 5000/cs
7 on. foam cups 1000/cs



Plastic pails
1-2-5 Gal.
With or without lid

SAFETY CANS



Scepter



"JERRY CAN"
The Original
1 - 2 - 5 gal.



Safety
Cabinets

Double-wall construction provides an insulating air space and helps prevent the spread of flames if a fire occurs. Dual vents allow hazardous vapours to be piped away when necessary. Ribs on galvanized 18-gauge reinforced steel shelves enhance rigidity and trap accidental spills. Shelves mount on permanent tabs for strong support and adjust at 6cm (2 1/4") intervals.



CONVEX MIRRORS
INSIDE/OUTSIDE
12" - 18" - 26" - 30" - 36"

Specialty Cans



Part #07079
AB10 2 1/2 gal./ 10L Gas Can

Part #07539
AB25 6.6 gal./ 25L Gas Can



Part #07649
D20 5.3 gal./ 20L Diesel Can



Part #07624
K20 5.3 gal./ 20L Kerosene Can



Part #03711
D520 5.3 gal./ 20L "Jeep Style" Diesel Can

Automotive Products

Regular Fuel Containers

Scepter developed the first plastic Jerry Can, setting the standards for the industry. Since the original appeared in 1959, we have continued to refine it as new technology made improvements possible. Made from high density polyethylene, the lightweight, crushproof design has extra headspace built in to accommodate expansion. Our new style of Jerry Cans now features a more user-friendly "easy pour" design, self-venting spouts and Child Resistant Closure (CRCs) caps. Scepter Jerry Cans are rustproof, unbreakable and noncorroding. Scepter cans meet or exceed U.S., Canadian, Australian and New Zealand standards. Scepter fuel cans come in a variety of sizes and styles for any application.





UNIVERSAL CIRCUIT BREAKER LOCKOUT

There are hundreds of different circuit breakers with toggle styles and shapes. The new North CBU01 Universal Circuit breaker made from durable Nylon will solve your problem, this C-SAFE circuit breaker lockout will fit most major brands of electrical circuit breakers single or double with a metal tie found in the industry. Can be installed in series and tools are not required.

Part #	Description
CBU01	Universal circuit breaker lockout, 6/pkg

MULTI-PURPOSE CABLE LOCKOUTS



The new North Cable Lockouts has been designed to allow safer working conditions by making safety compliance easier to achieve. The flexible design allows many different types of devices to be quickly and safely locked or immobilized. This device can be used on a single or multiple gate valve and circuit breaker boxes. They can also be used to immobilize large or awkwardly shaped machines and mechanisms.

Part #	Description
CBLOK06R	Cable Lockout Device with 6ft Cable
CBLOK10R	Cable Lockout Device with 10ft Cable
CBL06	6ft Replacement cable
CBL10	10ft Replacement cable

LOCK & PROTECT YOUR VALVE



With "The Original" lockout.

Part #	Description
VS02	1" - 2 1/2" (2.5cm - 6cm)
VS04	2 1/2" - 5" (6cm - 13cm)
VS06*	5" - 6 1/2" (13cm - 16.5cm)
VS09*	6 1/2" - 10" (16.5cm - 25cm)
VS13*	10" - 14" (25cm - 36cm)

Note: V-Safe lockouts are available in blue, green, red and yellow
* Red color only are class "A" stock items

VALVE LOCKOUT



Safe, efficient and inexpensive. 3 different sizes to lock your Ball Valves.

Part #	Width	Height	Length of Handle	Lock Hole
Ball Valve Lockout				
BS01	3.100" 80 mm	3.250" 82 mm	5.375" to 7.500" 135 mm to 190 mm	0.312" dia 8 mm
BS02	3.750" 95 mm	5.000" 125 mm	7.500" to 10.000" 190 mm to 250 mm	0.312" dia 8 mm
BS03	4.000" 100 mm	7.450" 186 mm	12.000" to 17.500" 300 mm to 438 mm	0.312" dia 8 mm
Butterfly Valve Lockout				
BS04	4.000" 102 mm	2.750" 70 mm	12.000" 305 mm	0.375 9.5 mm

Note: B-Safe lockouts are available in blue, green, red and yellow
* Red color only are class "A" stock items

ELECTRICAL PLUG LOCKOUT



The E-SAFE "Lock-A-Plug" completely encloses the plug from any accidental reconnection.

Part #	Width	Inside Height	Inside Width	Lock Hole	Cable Hole
LP110	3.250" 82 mm	1.750" 44.5 mm	1.750" 44.5 mm	0.312" dia 8 mm	0.500" 12 mm
LP550	12" 305 mm	2.750" 70 mm	4.000" 102 mm	0.375" dia 9.5 mm	1.000" 25 mm



LSE104F

\$



LSE106F

LOCKOUT & TAGOUT STATIONS

Part #	Description
LSE103F	Personal lockout station 11" x 14" Contents: (4) 3D Master lock (blue bumper padlock) (1) package of ELA290 "Do not operate" tags (pack of 25)
LSE104F	Lockout station 11" x 14" Contents: (4) 3D Master lock (blue bumper padlock) (1) package of ELA290 "Do not operate" tags (pack of 25) (3) R60 ML 1" safety lockout hasps
LSE105F	Lockout Station 14" x 21" Contents: (10) 3D master lock (blue bumper padlock) (2) package of ELA290 "Do not operate" tags (pack of 25) (3) R60 ML 1" safety lockout hasps
LSE106F	Departmental lockout Station 21" x 29" Contents: (20) 3D master lock (blue bumper padlock) (4) package of ELA290 "Do not operate" tags (pack of 25) (6) R60 ML 1" safety lockout hasps

C-SAFE

CB01

Single pole lockout, CB01 requires a switch breaker with a recessed hole. 6/pkg

Sugg. List: \$36.25 PK



CB03

A single pole lockout, CB03 does not require a switch breaker with recessed hole. 6/pkg

Sugg. List: \$27.95 PK



CB04

A double pole circuit breaker lockout, CB04 will fit most major brands of electrical circuit breaker. 6/pkg

Sugg. List: \$53.50 PK



E-SAFE

ES01

Electrical Switch Lockout, locks switch in either ON or OFF position, easy to install. 6 per pack

Sugg. List: \$41.95 EA



M-SAFE

MS01

Safety Lockout Hasps - Nylon
Inexpensive • Versatile • Dielectric

Sugg. List: \$4.75 EA



MS86

METAL LOCKOUT HASP. Accommodates six padlocks, made of tempered steel, individually packed - 72/box

Sugg. List: \$10.95 EA



LOCKOUT KITS

It is imperative that workers properly lockout/tagout machinery and equipment to prevent serious injury. The lockout kit provides all items required to make lockout/tagout as convenient and easy as possible.



Sugg. list price

Part #	Content
LK107FE	(1) 16" tool box w/tray, (1) VS02, (1) BS01, (1) #3D, (1) #1DLJ, (1) MS01, (5) ELA290, (1) CB04, (1) CB03, (1) ES01, (1) LP110

ELECTRIC LOCKOUT KITS

This kit provides all items to properly secure electrical machinery and equipment from causing serious injury while being serviced. All items can be easily carried in a lightweight carrying bag.



Sugg. list price

Part #	Content
LK108FE	(1) Nylon carrying bag, (6) CB03, (6) CB01, (6) CB04, (6) ES01, (1) LP110, (1) LP550, (2) MS01, (1) 666RD, (2) #3D, (2) #1DLJ, (10) ELA290

BREAKER LOCKOUT KITS

When regular lockout/tagout on electrical panels are required, North has a convenient pouch that can be attached to a belt for easy use, including all products for proper lockout.

Sugg. list price



Part #	Content
LK112F	(1) Double belt loop zippered pouch, (3) ES01, (1) LP110, (4) CB04, (4) CB03, (1) CB02, (2) CB01

MASTER-KEYED SYSTEMS

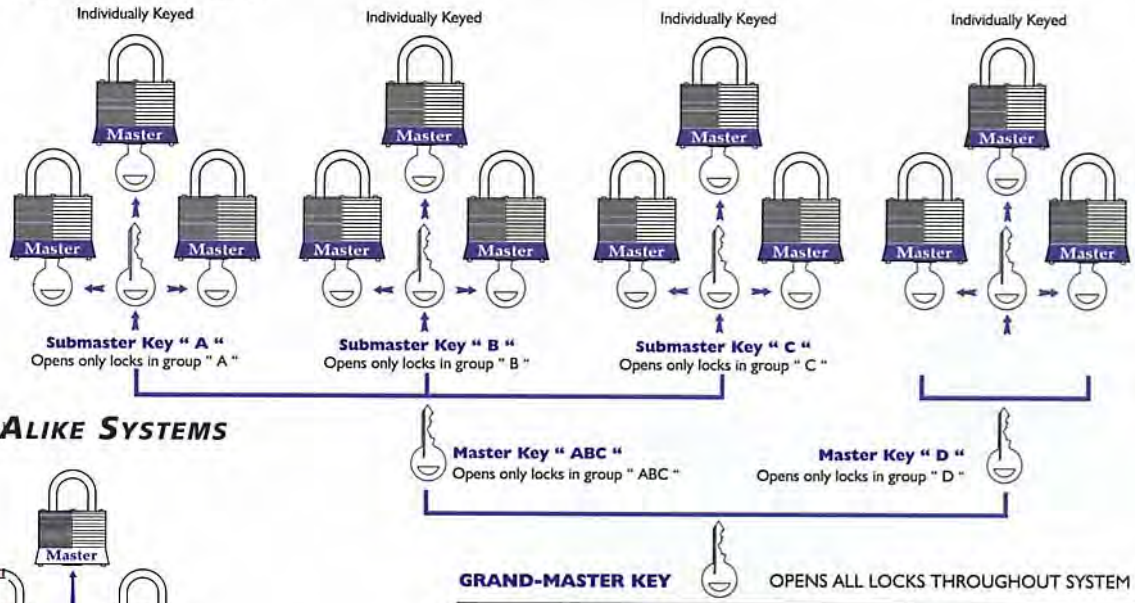

KEYED-ALIKE SYSTEMS

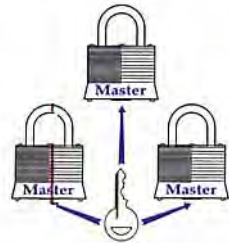

MODELS	DESCRIPTION
PADLOCK	1 1/4" (40 mm.) wide laminated steel body with case hardened steel shackle
3D	Individually keyed, regular shackle
3DLF	Individually keyed, 1 1/2" shackle
3DLH	Individually keyed, 2" shackle
3KA	Keyed alike, regular shackle
3KALF	Keyed alike, 1 1/2" long shackle
3KALH	Keyed alike, 2" long shackle
3MK	Master keyed, regular shackle
3MKLF	Master keyed, 1 1/2" shackle
3MKLH	Master keyed, 2" shackle
2K	Master Key
PADLOCK	1 3/4" (45 mm.) wide laminated steel body with case hardened steel shackle
1D	Individually keyed, regular shackle
1DLF	Individually keyed, 1 1/2" shackle
1DLJ	Individually keyed, 2 1/2" shackle
1KA	Keyed alike, regular shackle
1KALF	Keyed alike, 1 1/2" long shackle
1KALJ	Keyed alike, 2 1/2" long shackle
1MK	Master keyed, regular shackle
1MKLF	Master keyed, 1 1/2" shackle
1MKLJ	Master keyed, 2 1/2" shackle
2K	Master Key
PADLOCK	2" (50 mm.) wide laminated steel body with case hardened steel shackle
5D	Individually keyed, regular shackle
5DLF	Individually keyed, 1 1/2" shackle
5DLJ	Individually keyed, 2 1/2" shackle
5KA	Keyed alike, regular shackle
5KALF	Keyed alike, 1 1/2" long shackle
5KALJ	Keyed alike, 2 1/2" long shackle
5MK	Master keyed, regular shackle
5MKLF	Master keyed, 1 1/2" shackle
5MKLJ	Master keyed, 2 1/2" shackle
2K	Master Key

- MASTER-KEYED SYSTEMS**
 Supervisory master-key opens all locks in system yet each padlock also opens with a separate individual key. Permits organizing submaster, master and grandmaster systems along departmental or other functional lines, as illustrated (Padlocks are specially configured, regular locks will not accommodate Master-keying).
- KEYED-ALIKE SYSTEMS**
 Locks in KA sets employ identical keys. One key opens all in set.

Master



METAL LOCKOUT HASPS

C KEYS STORAGE MODULE

This module, which is very useful in padlock management, allows the person responsible for lockout to maintain the duplicates of all padlock keys (Personal, serial numbered, borrowed, etc.) up to date.

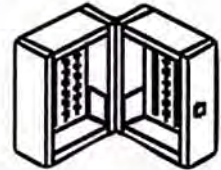

Models	Description	Sizes
ID 002/32	Single module 32 keys	10 X 10 X 3"
ID 002/72	Single module 72 keys	10 X 20 X 3"
ID 002/128	Single module 128 keys	18 X 18 X 3"
ID 003/64	Single module 64 keys	10 X 10 X 6"
ID 003/144	Single module 144 keys	10 X 20 X 6"
ID 003/256	Single module 256 keys	18 X 18 X 6"

All padlocks come with a standard blue bumper. Color code lock available (bumper): black

ABUS GRANIT



ABUS Nr. 37/55

- Provided with **ABUS**-Plus virtually pickproof security mechanism approx. 250.000 key differs.
Constructed and tested to satisfy the very stringent specifications of Swedish Insurance Companies, classified in class 3.
- Thermoplastic covered hardened steel lock body.



ABUS Nr. 37/60

- Small shackle clearance, leaves no room for bolt cutters and jimmies.
- Detachable shackle, enclosed by impact tested steel adaptor integrated into lock body.
- Keyhole provided with dust-cover to protect the cylinder from dust and moisture.
- All parts galvanized for maximum corrosion resistance.

Catalogue n°		37/55	37/55 HB 50	37/60	38/55	38/55 HB
Size	mm	56	56	62	56	56
Shackle Dia.	mm	11	11	11	11	11
		7	7	7	-	-
		-	-	-	5	5
Number of pins		-	-	-	-	-
Vertical Clearance	mm	26	50	16	26	50
Horizontal Clearance	mm	28	28	17	28	28





CONTRACTORS AIR

- Application** : For mining, construction, and industrial use
- Cover** : Yellow cut and abrasion resistant rubber
- Reinforcement** : Multiple layers of synthetic yarn
- Tube** : Synthetic oil mist resistant
- Temperature** : -35C to +80C(-30F to +180F)

Nom. I.D	Nom. O.D	PSI	Weight (lbs)	Std Pack Qty	Part #
1/2"	0.91"	300	0.32	50'	CAY-050-50
1/2"	0.91"	300	0.32	100'	CAY-050-100
3/4"	1.18"	300	0.48	50'	CAY-075-50
3/4"	1.18"	300	0.48	100'	CAY-075-100
1"	1.50"	300	0.70	50'	CAY-100-50
1"	1.50"	300	0.70	100'	CAY-100-100
1-1/4"	1.69"	300	0.73	50'	CAY-125-50
1-1/4"	1.69"	300	0.73	100'	CAY-125-100
1-1/2"	1.97"	300	0.93	50'	CAY-150-50
1-1/2"	1.97"	300	0.93	100'	CAY-150-100
2"	2.60"	300	1.56	50'	CAY-200-50
2"	2.60"	300	1.56	100'	CAY-200-100
2-1/2"	3.03"	250	1.67	100'	CAY-250
3"	3.66"	250	2.00	100'	CAY-300
4"	4.68"	250	2.71	100'	CAY-400

Cut Lengths : Plus 10%

Standard Lengths : 50'/100'

Recommended Couplings : High Pressure all sizes, mine stem and nut 1/2" - 2", Universal quick acting 1/2" - 1"



SUPER SERVICE AIR

- Application** : A superior quality mining, construction and industrial hose
- Cover** : Yellow cut and abrasion resistant rubber with blue stripe
- Reinforcement** : Multiple layers of synthetic yarn
- Tube** : Synthetic oil mist resistant
- Temperature** : -35C to +80C(-30F to +180F)

Nom. I.D	Nom. O.D	PSI	Weight (lbs)	Std Pack Qty	Part #
1/2"	0.91"	400	0.32	50'	SSY-050-50
1/2"	0.91"	400	0.32	100'	SSY-050-100
3/4"	1.26"	400	0.58	50'	SSY-075-50
3/4"	1.26"	400	0.58	100'	SSY-075-100
1"	1.50"	400	0.70	50'	SSY-100-50
1"	1.50"	400	0.70	100'	SSY-100-100
1-1/4"	1.85"	400	1.04	50'	SSY-125-50
1-1/4"	1.85"	400	1.04	100'	SSY-125-100
1-1/2"	2.09"	400	1.20	50'	SSY-150-50
1-1/2"	2.09"	400	1.20	100'	SSY-150-100
2"	2.60"	400	1.56	50'	SSY-200-50
2"	2.60"	400	1.56	100'	SSY-200-100
2-1/2"	3.11"	400	1.56	100'	SSY-250
3"	3.74"	400	2.86	100'	SSY-300
4"	4.72"	400	3.02	100'	SSY-400

Cut Lengths : Plus 10%. No cut lengths on 2-1/2" - 3" or 4"

Standard Lengths : 50'/100'

Product Information : Please specify length required when ordering, i.e. 50', 100'.

Recommended Couplings : High Pressure all sizes, mine stem and nut 1/2" - 2", Universal quick acting 1/2" - 1"



GENERAL PURPOSE

Application : General air-line and water service both in plant and outdoors
Cover : Red smooth weather and abrasion resistant synthetic rubber
Reinforcement : Multiple layers of synthetic yarns
Tube : Black oil mist resistant synthetic rubber
Temperature : -30C to +80C(-22F to +180F)

Nom. I.D	Nom. O.D	PSI	Weight (lbs)	Std Pack Qty	Part #
1/4"	0.55"	250	0.13	300'	GP-025-250
3/8"	0.67"	200	0.19	300'	GP-038-200
3/8"	0.71"	250	0.19	300'	GP-038-250
1/2"	0.83"	200	0.23	300'	GP-050-200
1/2"	0.87"	250	0.27	300'	GP-050-250
3/4"	1.16"	250	0.42	300'	GP-075-250
1"	1.42"	200	0.54	300'	GP-100-200
1-1/4"	1.73"	150	0.64	100'	GP-125-150
1-1/2"	2.05"	150	0.74	100'	GP-150-150
2"	2.60"	150	1.01	100'	GP-200-150

Cut Lengths : Plus 5%

Standard Lengths : 1/4"- 1" 50'/100'/300'. 1-1/4" - 2" 50'/100'.

Recommended Couplings : High Pressure 1" - 1-1/2" for air service if the working pressure exceeds 150 psi. High Pressure, Short shank, universal, or Combination nipples all other sizes.



EPDM GENERAL PURPOSE

Application : Air, water, agricultural spray solutions, and other dilute chemicals Excellent resistance to heat and weathering Also resists animal fats, vegetable oils.
Cover : Smooth red abrasion and weather resistant EPDM synthetic rubber
Reinforcement : Multiple layers of synthetic yarn
Tube : Synthetic oil mist resistant EPDM synthetic rubber
Temperature : -30C to +93C(-20F to +200F)

Nom. I.D	Nom. O.D	PSI	Weight (lbs)	Std Pack Qty	Part #
1/4"	0.55"	250	0.13	300'	GPE-025-250
5/16"	0.63"	250	0.16	300'	GPE-031-250
3/8"	0.68"	150	0.15	300'	GPE-038-150
3/8"	0.67"	200	0.16	300'	GPE-038-200
3/8"	0.71"	250	0.19	300'	GPE-038-250
1/2"	0.83"	200	0.23	300'	GPE-050-200
1/2"	0.87"	250	0.27	300'	GPE-050-250
5/8"	0.98"	250	0.31	300'	GPE-063-250
3/4"	1.16"	250	0.42	300'	GPE-075-250
1"	1.42"	200	0.55	300'	GPE-100-200
1-1/4"	1.77"	150	0.62	100'	GPE-125-150
1-1/2"	2.00"	150	0.73	100'	GPE-150-150
2"	2.50"	150	1.10	100'	GPE-200-150

Cut Lengths : Plus 5%

Standard Lengths : 1/4"- 1" 50'/100'/300' reels approx, 1-1/4" - 1-1/2" 50'/100'/400'/500' reels approx, 2" 50'/100'/300' reels approx

Recommended Couplings : High Pressure 1" - 1-1/2" for air service if the working pressure exceeds 150 psi. High Pressure, Short shank, universal, or Combination nipples all other sizes.



CONTRACTORS WATER DISCHARGE

- Application** : A lightweight water discharge hose which is ideal for use with portable pumps, and general water discharge service
- Cover** : Black abrasion and weather resistant synthetic rubber.
- Reinforcement** : Two plies of polyester yarns.
- Tube** : Black synthetic rubber compounded for water service.
- Temperature** : -35C to +80C(-30F to +180F)

Nom. I.D	Nom. O.D	PSI	Weight (lbs)	Std Pack Qty	Part #
1-1/4"	1.50"	100	0.34	100'	CWB-125
1-1/2"	1.73"	100	0.39	100'	CWB-150
2"	2.24"	100	0.51	100'	CWB-200
2-1/2"	2.76"	75	0.72	100'	CWB-250
3"	3.27"	75	0.86	100'	CWB-300
4"	4.29"	75	1.02	100'	CWB-400
6"	6.30"	75	1.77	100'	CWB-600

Cut Lengths : Plus 10%
Standard Lengths : 50'/100'
Recommended Couplings : Cam and groove or short shank



CONTRACTORS PLUS WATER DISCHARGE

- Application** : A Medium duty water discharge hose for use on construction sites and general water service
- Cover** : Black abrasion and weather resistant synthetic rubber.
- Reinforcement** : Multiple layers of synthetic yarns.
- Tube** : Black synthetic rubber compounded for water service.
- Temperature** : -35C to +80C(-30F to +180F)

Nom. I.D	Nom. O.D	PSI	Weight (lbs)	Std Pack Qty	Part #
1-1/4"	1.57"	100	0.38	100'	CWBY-125
1-1/2"	1.81"	100	0.52	100'	CWBY-150
2"	2.32"	100	0.69	100'	CWBY-200
2-1/2"	2.79"	100	0.72	100'	CWBY-250
3"	3.35"	100	0.99	100'	CWBY-300
4"	4.33"	100	1.21	100'	CWBY-400
6"	6.38"	100	2.28	100'	CWBY-600
8"	8.38"	75	3.47	100'	CWBY-800
10"	10.43"	75	4.58	50'	CWBY-1000
12"	12.52"	75	5.56	50'	CWBY-1200

Cut Lengths : Plus 10%
Standard Lengths : 50'/100'
Recommended Couplings : Cam and groove or short shank

**BLUE LAYFLAT**

WATER DISCHARGE

Application : A light duty layflat hose for portable pump and irrigation use.
Cover : Blue PVC impregnation.
Reinforcement : Woven high tensile synthetic yarns.
Tube : Blue PVC impregnation.
Temperature : -10C to +55C(15F to +130F)

Nom. I.D	Nom. O.D	PSI	Weight (lbs)	Std Pack Qty	Part #
3/4"	0.95"	150	0.11	300'	BLAY-075
1"	1.11"	150	0.13	300'	BLAY-100
1-1/4"	1.37"	130	0.15	300'	BLAY-125
1-1/2"	1.63"	70	0.15	300'	BLAY-150
2"	2.13"	65	0.20	300'	BLAY-200
2-1/2"	2.63"	65	0.27	300'	BLAY-250
3"	3.13"	60	0.33	300'	BLAY-300
4"	4.14"	60	0.46	300'	BLAY-400
5"	5.15"	45	0.65	300'	BLAY-500
6"	6.15"	35	0.78	300'	BLAY-600
8"	8.16"	35	1.22	300'	BLAY-800
10"	10.20"	35	1.75	300'	BLAY-1000
12"	12.30"	30	2.50	300'	BLAY-1200

Cut Lengths : Plus 10%

Standard Lengths : Multiples of 50' up to 300' maximum

Safety Information : Reduce pressures by 50% at maximum working temperature

Recommended Couplings : Cam and groove or short shank

BROWN LAYFLAT

Application : Heavy duty layflat hose for portable pump and irrigation use.
Cover : Brown PVC impregnation.
Reinforcement : Woven high tensile synthetic yarns.
Tube : Brown heavy PVC impregnation.
Temperature : -10C to +60C(15F to +140F)

Nom. I.D	Nom. O.D	PSI	Weight (lbs)	Std Pack Qty	Part #
1-1/2"	1.66"	130	0.20	300'	BRLAY-150
2"	2.16"	115	0.28	300'	BRLAY-200
3"	3.18"	100	0.46	300'	BRLAY-300
4"	4.18"	90	0.68	300'	BRLAY-400
6"	6.18"	70	1.10	300'	BRLAY-600
8"	8.19"	60	1.66	300'	BRLAY-800

Cut Lengths : Plus 10%

Standard Lengths : Multiples of 50' up to 300' maximum

Safety Information : Reduce pressures by 50% at maximum working temperature

Recommended Couplings : Cam and groove or short shank



SATURN PVC WATER S&D

Application	: An economical, flexible hose for construction pumps, septic tank & marine pump-out service. Resistant to some chemicals, mild acids & alkalis. Consult us for recommendations. Soft compounds allow for increased flexibility
Cover	: Clear abrasion and weather resistant extra soft PVC.
Reinforcement	: Blue PVC helix.
Tube	: Smooth clear extra soft PVC.
Temperature	: -25C to +65C(-13F to +150F)

Nom. I.D	Nom. O.D	Vacuum (Hg)	Bend Radius	PSI	Weight (lbs)	Std Pack Qty	Part #
3/4"	1.02"	26"	3.00	85	0.20	100'	SAT-075
1"	1.25"	26"	3.00	80	0.25	100'	SAT-100
1-1/4"	1.53"	26"	3.20	70	0.33	100'	SAT-125
1-1/2"	1.83"	24"	3.50	65	0.39	100'	SAT-150
2"	2.35"	24"	5.00	60	0.60	100'	SAT-200
2-1/2"	2.87"	22"	7.00	60	0.80	100'	SAT-250
3"	3.40"	22"	9.00	60	1.00	100'	SAT-300
4"	4.50"	22"	13.00	50	1.60	100'	SAT-400
6"	6.56"	16"	24.00	40	2.90	100'	SAT-600

Cut Lengths : Plus 10%

Standard Lengths : 100'

Safety Information : Suction and Pressure ratings are based on a temperature of 20C (68F), reduce by 50% at maximum working temperature

Recommended Couplings : Cam and groove or short shank



RUBBER WATER S&D

Application	: A heavy duty wire reinforced rubber suction hose for construction, quarries and general use.
Cover	: Black smooth abrasion and weather resistant synthetic rubber.
Reinforcement	: High tensile wire helix embedded between layers of textile cords.
Tube	: Smooth black synthetic rubber.
Temperature	: -30C to +80C(-22F to +180F)

Nom. I.D	Nom. O.D	Vacuum (Hg)	Bend Radius	PSI	Weight (lbs)	Std Pack Qty	Part #
3/4"	1.14"	29"	2.00"	200	0.50	100'	WSB-075
1"	1.42"	29"	3.00"	150	0.68	100'	WSB-100
1-1/4"	1.65"	29"	4.00"	150	0.77	100'	WSB-125
1-1/2"	1.93"	29"	4.00"	150	1.00	100'	WSB-150
2"	2.48"	29"	5.00"	150	1.45	100'	WSB-200
2-1/2"	2.99"	29"	8.00"	150	1.84	100'	WSB-250
3"	3.50"	29"	10.00"	150	2.23	100'	WSB-300
4"	4.64"	29"	14.00"	125	3.72	100'	WSB-400
5"	5.67"	29"	20.00"	125	3.90	100'	WSB-500
6"	6.66"	29"	30.00"	125	5.10	100'	WSB-600
8"	8.90"	29"	65.00"	50	8.83	60'	WSB-800
10"	10.90"	29"	80.00"	50	12.00	40'	WSB-1000
12"	12.99"	29"	100.00"	50	18.57	20'	WSB-1200

Cut Lengths : Plus 10%

Standard Lengths : 3/4" to 4" - 50'/100' -- 5" and 6" - 20'/100' -- 8" - 20'/60' -- 10" - 40' -- 12" - 20'



GARAGE EXHAUST HOSE

Application : Garage Exhaust hose is manufactured in 11' lengths. An all rubber construction results in a crush-proof product. Heat resistant EPDM rubber resists high temperature of exhaust emissions. An exclusive patented Flarelock design allows you to splice, connect and re-connect as needed.

Cover Temperature : High Temperature EPDM
: up to 400F(600F Intermittent)

Standard Lengths : 11'

Description	Weight (lbs)	Part #	Description	Weight (lbs)	Part #
2" X11' GARAGE EXHAUST	7.00	GXC-200	UNIVERSAL ADAPTER	1.42	GXC-UA
2-1/2"X11' GARAGE EXHAUST	7.00	GXC-250	Y-ADAPTER ALUMINUM 2-1/2"	4.00	GXC-YA
3"X11' GARAGE EXHAUST	9.40	GXC-300	Y-ADAPTER RUBBER 3"	2.00	GXC-YR
4"X11' GARAGE EXHAUST	16.00	GXC-400	Y-ADAPTER ALUMINUM 4"	4.25	GXC-YA4
5"X11' GARAGE EXHAUST	21.00	GXC-500	DUAL EXHAUST ADAPTER	1.66	GXC-DX
DOOR PORT	1.08	GXC-DP	DIESEL ELBOW ADAPTER	6.00	GXC-DE
3" DOOR PORT	1.30	GXC-DP3	5" DIESEL STACK ADAPTER RUBBER	5.00	GXC-DS5



INDUSTRIAL VACUUM

Application : For handling abrasive dust from wood, metal, rock, marble and concrete grinding machines under vacuum.

Cover Reinforcement Tube : Black abrasion resistant rubber, corrugated for flexibility.
: A high tensile steel helix embedded between layers of textile cords.
: 1/16 black abrasion resistant synthetic rubber standard. 1/8 thick tube stocked in 4", other sizes available on request.

Temperature : -30C to +80C(-25F to +180F)

Nom. I.D	Nom. O.D	Vacuum (Hg)	Bend Radius	PSI	Weight (lbs)	Std Pack Qty	Part #
1"	1.38"	24"	4.00"	40	0.39	100'	IVB-100
1-1/4"	1.65"	24"	5.00"	40	0.48	100'	IVB-125
1-1/2"	1.97"	24"	6.00"	40	0.60	100'	IVB-150
2"	2.40"	20"	7.00"	40	0.70	100'	IVB-200
2-1/2"	2.95"	18"	10.00"	40	1.03	100'	IVB-250
3"	3.42"	14"	12.00"	40	1.20	100'	IVB-300
3-1/2"	3.90"	12"	14.00"	40	1.29	100'	IVB-350
4"	4.45"	12"	15.00"	40	1.98	100'	IVB-400
4-1/2"	4.96"	10"	18.00"	40	2.05	100'	IVB-450
5"	5.51"	10"	22.00"	40	2.87	100'	IVB-500
6"	6.53"	10"	24.00"	40	3.84	100'	IVB-600

Cut Lengths : Plus 10%

Standard Lengths : 100'

Product Information : Longer lengths available, check for price and availability

Recommended Couplings : Cam and groove

SINGLE JACKET RUBBER LINED 500 PSI



- Application** : An approved hose for light duty fire protection.
Cover : All polyester circular woven jacket with good abrasion resistance.
Tube : Smooth synthetic rubber.
Temperature : -35C to +80C(-30F to +180F)

Nom. I.D	Bowl Size	Test PSI	Service PSI	Weight (lbs)	Std Pack Qty	Part #
1-1/2"	1-3/4"	500	250	0.26	100'	SJ5-150
1-3/4"	1-15/16"	500	250	0.38	100'	SJ5-175
2"	2-3/8"	500	250	0.42	100'	SJ5-200
2-1/2"	2-3/4"	500	250	0.48	100'	SJ5-250
3"	3-3/8"	500	250	0.62	100'	SJ5-300

Standard Lengths : 50'/100'

Product Information : 1-1/2", 2-1/2" U.L. Listed

Recommended Couplings : Fire hose expansion ring

DOUBLE JACKET 800 PSI



- Application** : Municipal fire fighting service and heavy duty industrial applications.
Cover : Two circular woven all polyester jackets for good abrasion resistance.
Tube : Smooth synthetic rubber.
Temperature : -35C to +80C(-30F to +180F)

Nom. I.D	Bowl Size	Test PSI	Service PSI	Weight (lbs)	Std Pack Qty	Part #
1-1/2"	1-15/16"	800	400	0.36	100'	DJ8-150
1-3/4"	2-5/32"	800	400	0.42	100'	DJ8-175
2"	2-1/2"	800	400	0.48	100'	DJ8-200
2-1/2"	3"	800	400	0.64	100'	DJ8-250
3"	3-9/16"	800	400	0.82	100'	DJ8-300

Standard Lengths : 50'/100'

Product Information : 1-1/2", 2-1/2" U.L. Listed

Recommended Couplings : Fire hose expansion ring



PLASTIC FOG NOZZLE GHT 3/4" - 1" - 1 1/2" - 2"



BRASS NOZZLE 3/4" - 1" - 1 1/2" - 2"



CSA/NPT BRASS HYDRANT ADAPTER

HAMMERLOCK TOOLS

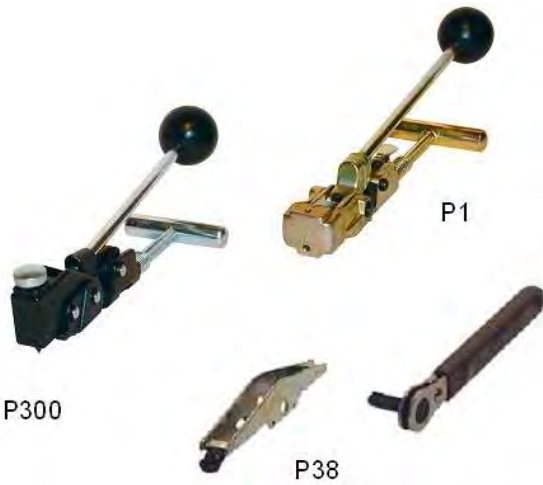

Description	Weight (lbs)	Std Pack Qty
P1 HAMMER LOCK TOOL	2.80	1
P1000 TOOL	3.00	1
P300 TOOL	3.30	1
P38 TOOL	1.00	1

PREFORMED CLAMP



Description	Weight (lbs)	Std Pack Qty	Part #
1" PREFORMED CLAMP 5/8" WIDE	0.07	100	CP-04
1-1/4" PREFORMED CLAMP 5/8" WIDE	0.08	100	CP-05
1-1/2" PREFORMED CLAMP 5/8" WIDE	0.08	100	CP-06
1-3/4" PREFORMED CLAMP 5/8" WIDE	0.09	100	CP-07
2" PREFORMED CLAMP 5/8" WIDE	0.10	100	CP-08
2-1/4" PREFORMED CLAMP 5/8" WIDE	0.11	100	CP-09
2-1/2" PREFORMED CLAMP 5/8" WIDE	0.12	50	CP-10
2-3/4" PREFORMED CLAMP 5/8" WIDE	0.12	50	CP-11
3" PREFORMED CLAMP 5/8" WIDE	0.13	50	CP-12
3-1/2" PREFORMED CLAMP 5/8" WIDE	0.15	50	CP-14
4" PREFORMED CLAMP 5/8" WIDE	0.16	25	CP-16
4-1/2" PREFORMED CLAMP 5/8" WIDE	0.18	25	CP-18
5" PREFORMED CLAMP 5/8" WIDE	0.19	25	CP-20
6" PREFORMED CLAMP 5/8" WIDE	0.23	25	CP-24
6-1/2" PREFORMED CLAMP 5/8" WIDE	0.24	25	CP-26
7" PREFORMED CLAMP 5/8" WIDE	0.26	25	CP-28
8" PREFORMED CLAMP 5/8" WIDE	0.29	20	CP-32
1-3/16" PREFORMED CLAMP 3/8" WIDE	0.03	100	CP-03
1" PREFORMED CLAMP 3/8" WIDE	0.03	100	CP-310
1-3/8" PREFORMED CLAMP 3/8" WIDE	0.04	100	CP-311
2" PREFORMED CLAMP 3/8" WIDE	0.05	100	CP-316

DOUBLE BOLT CLAMP



Application	: A rugged ductile iron two bolt clamp with saddles				Part #
Size	Open	Bolt Torque FT LBS	Weight (lbs)		
21/32"	7/8"	15	0.22	DBC-22-DP	
7/8"	1-9/64"	15	0.33	DBC-29-DP	
1-5/16"	1-11/16"	15	0.35	DBC-34-DP	
1-5/16"	1-19/32"	20	0.48	DBC-40-DP	
1-5/8"	1-15/16"	25	0.40	DBC-49-DP	
1-7/8"	2-3/8"	25	0.70	DBC-60-DP	
2-3/8"	3-1/16"	25	0.79	DBC-76-DP	
3-1/2"	3-11/16"	40	1.32	DBC-94-DP	
3-3/4"	4-1/2"	40	2.20	DBC-115-DP	
3-1/2"	4"	40	1.76	DBC-400-DP	
3-13/16"	4-1/16"	40	2.20	DBC-431-DP	
4-1/16"	4-7/16"	40	1.76	DBC-463-DP	
4-3/16"	5"	60	2.31	DBC-525-DP	
5"	5-1/2"	60	2.31	DBC-550-DP	
5-1/2"	5-15/16"	60	2.64	DBC-600-DP	
5-11/16"	5-15/16"	60	2.60	DBC-639-DP	
6-1/8"	6-7/8"	60	2.64	DBC-675-DP	
6-15/16"	7-5/8"	60	3.30	DBC-769-DP	
7-11/16"	8-3/16"	125	5.29	DBC-818-DP	
8-1/4"	8-7/8"	125	5.29	DBC-875-DP	
8-15/16"	9-7/8"	125	5.95	DBC-988-DP	
9-15/16"	11-3/8"	125	9.36	DBC-1125-DP	
11-3/16"	13"	125	9.36	DBC-1275-DP	
12-3/16"	14"	200	14.50	DBC-1360-DP	
13-3/16"	15"	200	16.15	DBC-1450-DP	
15-1/16"	17-1/2"	260	21.29	DBC-1700-DP	



M10 MAXI CLAMP HEAVY

Application	: Rugged Heavy Duty Wide Band Clamp for use in medium pressure air and water applications					Part #
Size	Decimal Min	Decimal Max	Weight (lbs)	Std Pack Qty		
68-73mm	2.68"	2.90"	0.59	50	M10-68	
74-79mm	2.91"	3.14"	0.61	50	M10-74	
80-85mm	3.15"	3.38"	0.62	50	M10-80	
86-91mm	3.39"	3.61"	0.64	50	M10-86	
92-97mm	3.62"	3.85"	0.66	50	M10-92	
98-103mm	3.86"	4.08"	0.69	50	M10-98	
104-112mm	4.09"	4.44"	0.72	50	M10-104	
113-121mm	4.45"	4.79"	0.74	50	M10-113	
122-130mm	4.80"	5.15"	0.77	25	M10-122	
131-139mm	5.16"	5.50"	0.80	25	M10-131	
140-148mm	5.51"	5.86"	0.84	25	M10-140	
149-161mm	5.87"	6.37"	0.88	25	M10-149	
162-174mm	6.38"	6.88"	0.90	25	M10-162	
175-187mm	6.89"	7.39"	0.96	25	M10-175	
188-200mm	7.40"	7.86"	0.98	25	M10-188	
201-213mm	7.91"	8.42"	0.97	25	M10-201	
214-226mm	8.43"	8.90"	1.06	25	M10-214	
227-239mm	8.94"	9.44"	1.15	25	M10-227	
240-252mm	9.45"	9.92"	1.23	25	M10-240	
248-260mm	9.76"	10.24"	1.32	25	M10-248	

"AIR KING" UNIVERSAL COUPLINGS



CHICAGO COUPLINGS



HOSE ENDS

3/8"	AMH
1/2"	AM-1
5/8"	AM-5
3/4"	AM-6
1"	AM-11



MALE N.P.T. ENDS

1/4"	AMB-1
3/8"	AMB
1/2"	AM-2
3/4"	AM-7
1"	AM-12



FEMALE N.P.T. ENDS

1/4"	AMC-1
3/8"	AMC
1/2"	AM-3
3/4"	AM-8
1"	AM-13

"EZ-BOSS" GROUND JOINT SEAL

COUPLING WITH FEMALE SPUD



1/4"	GF-1
3/8"	GF-3
1/2"	GF-6
3/4"	GF-26
1"	GF-36
1 1/4"	GF-51
1 1/2"	GF-61
2"	GF-81
2 1/2"	GF-96
3"	GF-111
4"	GF-141
5"	GF-171
6"	GF-201

FEMALE STEM



1/4"	GB-A
3/8"	GCA
1/2"	GB-1
3/4"	GB-6
1"	GB-11
1 1/4"	GB-16
1 1/2"	GB-21
2"	GB-26
2 1/2"	GB-31
3"	GB-36
4"	GB-46

MALE STEM



1/4"	MSA
3/8"	MSC
1/2"	MS-1
3/4"	MS-6
1"	MS-11
1 1/4"	MS-16
1 1/2"	MS-21
2"	MS-26
2 1/2"	MS-31
3"	MS-36
4"	MS-46

FEMALE SPUD (Female N.P.T.)



1/4"	GBC
3/8"	GCC
1/2"	GB-3
3/4"	GB-8
1"	GB-13
1 1/4"	GB-18
1 1/2"	GB-23
2"	GB-28
2 1/2"	GB-33
3"	GB-38
4"	GB-48

SWIVEL NUT



1/4"	BA-2
3/8"	CB
1/2"	B-2
3/4"	B-12
1"	B-12
1 1/4"	B-17
1 1/2"	B-17
2"	B-27
2 1/2"	B-32
3"	B-37
4"	B-47

DOUBLE SPUD



1/2"	GDB-3
3/4"	GDB-13
1"	GDB-13
1 1/4"	GDB-23
1 1/2"	GDB-23
2"	GDB-28
2 1/2"	GDB-33
3"	GDB-38

MENDER



1/2"	M-1
3/4"	M-6
1"	M-11
1 1/4"	M-16
1 1/2"	M-21
2"	M-26
2 1/2"	M-31
3"	M-36
4"	M-46

MALE SPUD (Male N.P.T.)



1/4"	GMB
3/8"	GMC
1/2"	GM-3
3/4"	GM-8
1"	GM-13
1 1/4"	GM-18
1 1/2"	GM-23
2"	GM-28
2 1/2"	GM-33
3"	GM-38

CLAMP



3/4"	1 3/16"	1 5/16"	BU-9
3/4"	1 5/16"	1 1/2"	B-9
3/4"	1 1/2"	1 11/16"	B-10
1"	1 17/32"	1 23/32"	BU-14
1"	1 11/16"	1 27/32"	B-14
1"	1 7/8"	2 1/16"	B-15
1 1/4"	2 1/16"	2 1/4"	B-19
1 1/2"	2 3/32"	2 5/32"	BU-24
1 1/2"	2 1/4"	2 7/16"	B-24
1 1/2"	2 15/32"	2 23/32"	B-25
2"	2 1/2"	2 25/32"	BU-29
2"	2 3/4"	3 1/16"	B-29
2"	3 3/32"	3 7/16"	B-30
2 1/2"	3 1/2"	3 15/16"	B-34
3"	3 13/16"	4 3/16"	B-35
3"	4 1/16"	4 7/16"	B-39
4"	4 1/4"	4 13/16"	†BS-39
4"	4 7/8"	5 5/16"	†BU-49
4"	5 1/8"	6 3/16"	†B-49

CAST IRON VALVE



1/2"	V-33
3/4"	V-55
1"	V-77
1 1/4"	V-99
1 1/2"	V-119
2"	V-139
2 1/2"	V-250
3"	V-300

BALL VALVE



1/4"	BBV-25
3/8"	BBV-38
1/2"	BBV-50
3/4"	BBV-75
1"	BBV-100
1 1/4"	BBV-125
1 1/2"	BBV-150
2"	BBV-200

HOSE ACCESSORIES



HOSE MENDER

KC NIPPLES

1 1/2"	CAB150
2"	CAB200
2 1/2"	CAB250
3"	CAB300
4"	CAB400
6"	CAB600



TYPE "SHORT SHANK"

HOSE DIA.	NPT	NO.
1/4"	1/8"	3501
1/4"	1/4"	3502
1/4"	3/8"	3504
3/8"	1/4"	3505
3/8"	3/8"	3506
3/8"	1/2"	3508
1/2"	1/4"	3509
1/2"	3/8"	3510
1/2"	1/2"	3512
1/2"	3/4"	3511
3/4"	1/2"	3513
3/4"	3/4"	3514
3/4"	1"	3515
1"	3/4"	3516
1"	1"	3518

STEEL NIPPLES



GAUGES
0 - 5000 LBS

SAFETY CHECK VALVES

1/4" male NPT

Preset Press. PSI	SCFM	Part #
30	24	SV30
100	64	SV100
125	78	SV125
150	92	SV150
175	106	SV175
200	120	SV200



OETIKER



STYLE HTBC



NOMINAL SIZE	INCHES		PART NO.
	CLOSED	OPEN	
3/16"	.118	.197	0305
1/4"	.197	.276	0507
5/16"	.276	.354	0709
3/8"	.354	.433	0811
1/2"	.433	.512	1113
9/16"	.512	.591	1315
19/32"	.591	.669	1517
5/8"	.669	.748	1818
3/4"	.748	.827	1720
13/16"	.827	.905	1922
7/8"	.905	.984	2023
15/16"	.984	1.063	2225
1"	1.063	1.220	2327
1 1/8"	1.220	1.457	2731
1 7/16"	1.457	1.575	3437
1 1/2"	1.575		3740

O. D. RANGE FROM TO		PART NO.
2 5/32"	2 15/32"	HTBC238
2 9/32"	2 19/32"	HTBC250
2 25/32"	3 3/32"	HTBC300
3 9/32"	3 19/32"	HTBC350
3 25/32"	4 3/32"	HTBC400
4 9/32"	4 19/32"	HTBC450
4 25/32"	5 3/32"	HTBC500
5 9/32"	5 19/32"	HTBC550
5 25/32"	6 3/32"	HTBC600
6 9/32"	6 19/32"	HTBC650
6 25/32"	7 3/32"	HTBC700
7 9/32"	7 19/32"	HTBC750
7 25/32"	8 3/32"	HTBC800

CAM AND GROOVE FITTINGS



TYPE "A "



TYPE "E "



TYPE " B "



TYPE " F "



TYPE " C "



TYPE "DC "



TYPE "D "



TYPE "DP "

IN LINE LUBRICATORS

- NO. PL300 1/2"
- NO. PL400 3/4"
- NO. PL400L 3/4"
- NO. PL500 1"



FOOT VALVES



STRAINERS

Description	Weight (lbs)
SAFETYCHECK LARGE 1-1/2"-3"HOSE,37" LONG	1.30
SAFETYCHECK SMALL 1/2"-1-1/4"HOSE,22" LG	0.25



AIR FITTINGS and ACCESSORIES

"AIR CHIEF" INDUSTRIAL QUICK-CONNECT FITTINGS

INDUSTRIAL INTERCHANGE

"Air Chief" Industrial Quick-Connect Fittings are of the popular Industrial Interchange design and will interchange with many other makes. Rated to **300 PSI**. Interchanges with MIL Spec. C-4109. Temp. range - **40° to 250° F**.

SEMI-AUTOMATIC - PULL SLEEVE TO CONNECT
COUPLERS SHUT-OFF WHEN DISCONNECTED
FOR AIR SERVICE ONLY

1/4" Plugs

Flow Rating: (steel)
 37 CFM at 100 PSI



Size	Part #		
MALE NPT			
1/8"	DCP2101		
1/4"	DCP21		
3/8"	DCP2103		
FEMALE NPT			
1/8"	DCP2021		
1/4"	DCP20		
3/8"	DCP2023		
HOSE SHANK			
1/4"	DCP2142		
5/16"	DCP2143		
3/8"	DCP2144		
PUSH-ON HOSE BARB			
1/4"	DCP2142L		
3/8"	DCP2144L		

1/4" Couplers (brass)



Size	Part #		
MALE NPT			
1/8"	DC2101		
1/4"	DC21		
3/8"	DC2103		
FEMALE NPT			
1/8"	DC2021		
1/4"	DC20		
3/8"	DC2023		
HOSE SHANK			
1/4"	DC2042		
5/16"	DC2043		
3/8"	DC2044		
PUSH-ON HOSE BARB			
1/4"	DC2042L		
3/8"	DC2044L		

3/8" Plugs

Flow Rating: (steel)
 70 CFM at 100 PSI



Size	Part #		
MALE NPT			
1/4"	DCP2502		
3/8"	DCP25		
1/2"	DCP2504		
FEMALE NPT			
1/4"	DCP2622		
3/8"	DCP26		
1/2"	DCP2624		
HOSE SHANK			
1/4"	DCP2542		
3/8"	DCP2544		
1/2"	DCP2545		
PUSH-ON HOSE BARB			
1/4"	DCP2542L		
3/8"	DCP2544L		

3/8" Couplers (steel)

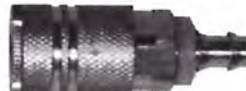

Size	Part #		
MALE NPT			
1/4"	DC2502		
3/8"	DC25		
1/2"	DC2504		
FEMALE NPT			
1/4"	DC2622		
3/8"	DC26		
1/2"	DC2624		
HOSE SHANK			
1/4"	DC2642		
3/8"	DC2644		
1/2"	DC2645		
PUSH-ON HOSE BARB			
1/4"	DC2642L		
3/8"	DC2644L		

1/2" Plugs

Flow Rating: (steel)
 150 CFM at 100 PSI



Size	Part #		
MALE NPT			
3/8"	DCP1703		
1/2"	DCP17		
3/4"	DCP1706		
FEMALE NPT			
3/8"	DCP1823		
1/2"	DCP18		
3/4"	DCP1826		
HOSE SHANK			
3/8"	DCP1744		
1/2"	DCP1745		
3/4"	DCP1746		

1/2" Couplers (steel)



Size	Part #		
MALE NPT			
3/8"	DC903		
1/2"	DC9		
3/4"	DC906		
FEMALE NPT			
3/8"	DC1023		
1/2"	DC10		
3/4"	DC1026		
HOSE SHANK			
3/8"	DC1044		
1/2"	DC1045		
3/4"	DC1046		

FITTINGS

Malleable Iron Screwed Fittings
WORKING PRESSURES UP TO 150 POUNDS

Sizes 1/8" to 4"

BLACK AND GALVANIZED



malleable iron unions

459
ground joint
bronze-to-iron

300 lb wsp
600 lb wog non-shock

Wrought Steel Nipples
Close To 12" Long



CHECK VALVES

BRASS
GATE VALVES

SHIM STOCK



SIX INCH WIDTHS
100 Inch Strips

Stock No.	Thickness	Stock No.	Thickness
305-601	.001	305-608	.008
305-602	.002	305-609	.009
305-603	.003	305-610	.010
305-604	.004	305-612	.012
305-605	.005	305-615	.015
305-606	.006	305-620	.020
305-607	.007	305-625	.025

Common Nails

FLAT HEADS—DIAMOND POINTS

These nails are used generally for building purposes. They represent the majority of all nails produced.



"ARDOX" SPIRAL STANDARD

Length Inches	Gauge No.	Approx. Count per Lb.
1	14	764
1 1/4	14	672
1 1/2	13 1/2	490
1 3/4	12 1/2	316
2	12 1/2	274
2 1/4	11 1/2	203
2 1/2	10 1/2	143
3	9 1/2	92
3 1/4	9 1/2	88
3 1/2	8	57
4	7	41
5	5	23
6	3	14.2
7	2	10.2
8	1	7.4
10	0	5
12	0	4.13
14	0	2.2



COMMON

Length Inches	Gauge No.	Approx. Count per Lb.
1	15	794
1 1/4	15	713
1 1/2	14	536
1 3/4	13	322
1 1/2	12	229
2	12	196
2 1/4	11	141
2 1/2	10	104
2 3/4	10	91
3	9	67
3 1/4	9	63
3 1/2	7	40
4	6	25
4 1/2	5	22
5	4	18
5 1/2	3	13
6	2	9

COUPLIX COUPLINGS



ELBOWS 11¼°
ELBOWS 22½°
ELBOWS 45°
ELBOWS 90°

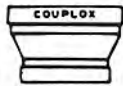

REDUCERS
 Fig. No. 2260

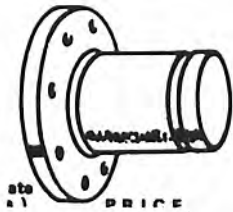

FLANGED ADAPTERS
 150# Forged Steel Flange
 Fig. No. 2310

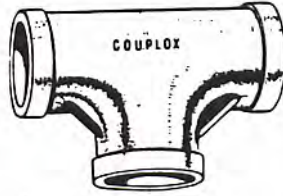

TEES
 Fig. No. 2250

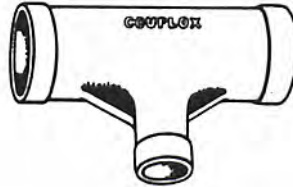

REDUCING TEES

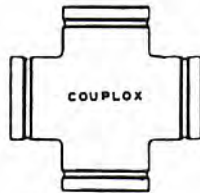

CROSSES
 Fig. No. 2370

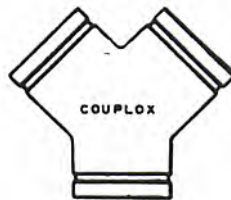

90° TRUE Y's
 Fig. No. 2390

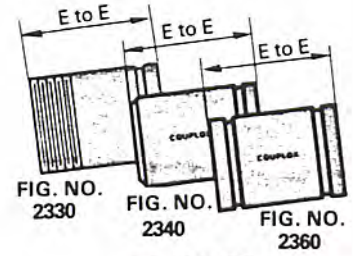

ADAPTERS
 Threaded, Bevelled, Plain
 or Grooved



**SWAGED
 HOSE NIPPLES**
 Fig. No. 2300

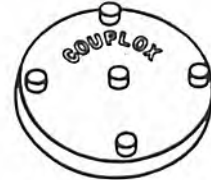

CAPS (Blank Ends)
 Fig. No. 2400



BUTTERFLY VALVE
 Figure No. 4000 Butterfly

BAND-IT TOOLS

Common BAND-IT® Brand Tools and Tool Repair/Replacement Parts List



C00169 - Standard Banding Tool
 Replacement Parts:
 C00689 – Tension handle and tension screw kit
 C01899 – Band Gripper
 C01687 – Thrust bearing
 C05887 – Cutterbar and handle assembly



C00369 – Heavy Duty Banding Tool
 Replacement Parts:
 C01899 – Band Gripper
 C07087 – Thrust bearing
 C05887 – Cutterbar and handle assembly
 C04986 – 5/8" Tension handle for tool



G40269 – Giant Banding Tool
 Replacement Parts:
 G40888 – Thrust bearing
 G42287 – Cutterbar and handle assembly



T30069 – Center Punch Tool - 5/8"
 Replacement Parts:
 T32190 – Punch and holder replacement kit
 T32290 – Clamp tail grippers replacement kit
 S03289 – Adaptor insert for 3/8" clamp installations



C00269 – Junior® Preformed Clamp Tool - complete
 Replacement Parts:
 C00689 – Tension handle and tension screw kit
 C01899 – Band Gripper
 C01687 – Thrust bearing
 J00587 – Shear hook
 J93099 – Junior® lock universal cutter blade kit



J00169 – Junior® Clamp Adaptor for use with C00169 Tool
 Replacement Parts:
 J00587 – Shear hook
 J93099 – Junior® lock universal cutter blade kit



J05069 – Junior® Heavy Duty Adaptor for use with C00169 Tool
 Replacement Parts:
 J00587 – Shear hook
 J93099 – Junior® lock universal cutter blade kit

For a complete list of available tool instructions and replacement parts, go to www.BAND-IT-IDEX.com/products/products_tools.html

Common BAND-IT® Brand Tools and Tool Repair/Replacement Parts List



S75099 – Pneumatic Junior® Clamp Application Tool
 Replacement Parts:
 S45799 – Band Gripper Kit
 J93099 – Junior® lock universal cutter blade kit
 J00587 – Shear hook
 S45087 – Tripper Plate



S35099 - Pneumatic Automatic Junior® Clamp Application Tool
 Replacement Parts:
 S45799 – Band Gripper Kit
 J93099 – Junior® lock universal cutter blade kit
 S45087 – Tripper Plate



SM1700 - Pneumatic Automatic Center Punch Clamp Application Tool
 Replacement Parts:
 S45199 – CP Band Gripper Kit
 M17799 – CP Cutter Blade Kit
 S45087 – Tripper Plate



UL4000 – Ultra-Lok® Portable Tool
 Replacement Parts:
 M21790 – Adapter Clutch
 M09387 – Shear plate for installing 1/2" wide UL clamps
 M09887 – Shear plate for installing 3/4" wide UL clamps
 M09787 – Cutter Blade for installing all UL clamps
 C23187 – Lubricant for tension threads
 UL1219 – Handle Kit



UL9010 – Ultra-Lok® AC Powered Tool
 Replacement Parts:
 M03990 – Adapter Clutch
 M09387 – Shear plate for installing 1/2" wide UL clamps
 M09887 – Shear plate for installing 3/4" wide UL clamps
 M09787 – Cutter Blade for installing all UL clamps
 C23187 – Lubricant for tension threads
 UL1219 – Handle Kit

UL9000 – Ultra-Lok® AC Powered Tool (1st Generation)
 Replacement Parts:
 M03990 – Adapter Clutch
 ULK249 – Upgrade kit to convert UL9000 to UL9010 features
 C23187 – Lubricant for tension threads

KITS



C27599 BAND-IT® Warehouse Kit



ID Kit ID3009



J10099 Pok-It Pak Kit

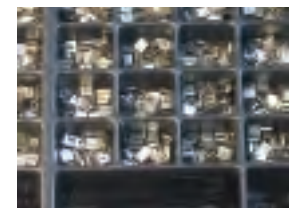

Easy Read Kit AE0609

201 Stainless Steel BAND-IT® BAND

Part No.	Material*	Width		Thickness		Average Breaking Strength (lbs)	Package Quantity	Package Weight		Application Tools
		In	mm	In	mm			Lbs	Kg	
C20299	201 SS	1/4	6.4	0.020	0.51	500	100'/roll	1.7	0.7	C00169 C00369 C07569 C08569 C40099 J02069†
C20399	201 SS	3/8	9.6	0.025	0.64	900	100'/roll	3.2	1.5	
C203Y9	201 SS	3/8	9.6	0.025	0.64	900	Yellow Tote 100'/roll	3.6	1.6	
C20499	201 SS	1/2	12.7	0.030	0.76	1500	100'/roll	5.1	2.3	
C204B9	201 SS	1/2	12.7	0.030	0.76	1500	Blue Tote 100'/roll	5.5	2.5	
C20599	201 SS	5/8	15.9	0.030	0.76	1875	100'/roll	6.4	2.9	
C205G9	201 SS	5/8	15.9	0.030	0.76	1875	Green Tote 100'/roll	6.8	3.1	
C20699	201 SS	3/4	19.1	0.030	0.76	2250	100'/roll	7.7	3.5	
C206R9	201 SS	3/4	19.1	0.030	0.76	2250	Red Tote 100'/roll	8.2	3.7	

† The J02069 can be used with 3/8" maximum width product.



Hand Tools for Band & Buckle



C00169 BAND-IT® Tool

BAND-IT® Buckle Ear-Lokt Style

Part No.	Material*	Width		Package Quantity	Package Weight	
		In	mm		Lbs	Kg
C25299**	SS	1/4	6.4	100/box	0.3	0.1
C25399	SS	3/8	9.6	100/box	0.8	0.4
C25499	SS	1/2	12.7	100/box	2.1	1.0
C25599	SS	5/8	15.9	100/box	2.4	1.1
C25699	SS	3/4	19.1	100/box	3.7	1.7

**Clip style.

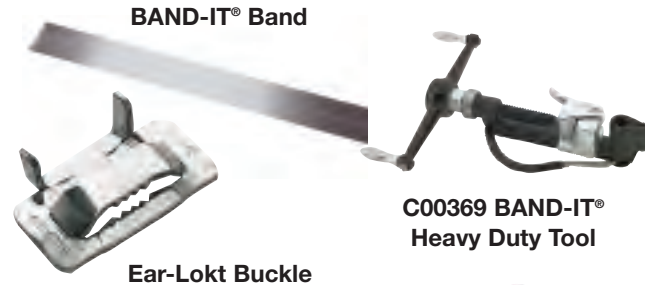

BAND-IT® Band

Ear-Lokt Buckle

C00369 BAND-IT® Heavy Duty Tool



C07569 Bantam Tool

Giant Band

Part No.	Material*	Width		Thickness		Average Breaking Strength (lbs)	Package Quantity	Package Weight		Application Tools
		In	mm	In	mm			Lbs	Kg	
G43099	201 SS	3/4	19.1	0.044	1.10	3300	100'/roll	11.6	5.4	C00369 (3/4" only)
G43199	201 SS	1	25.4	0.044	1.10	4400	100'/roll	13.7	6.4	G40269
G43299	201 SS	1 1/4	31.8	0.044	1.10	5500	100'/roll	17.2	8.0	

Galvanized Carbon Steel also available.

Giant Buckle Ear-Lokt Style

Part No.	Material*	Width		Package Quantity	Package Weight	
		In	mm		Lbs	Kg
G44099	SS	3/4	19.1	25/box	1.8	0.8
G44199	SS	1	25.4	25/box	2.4	1.1
G44299	SS	1 1/4	31.8	25/box	3.2	1.4

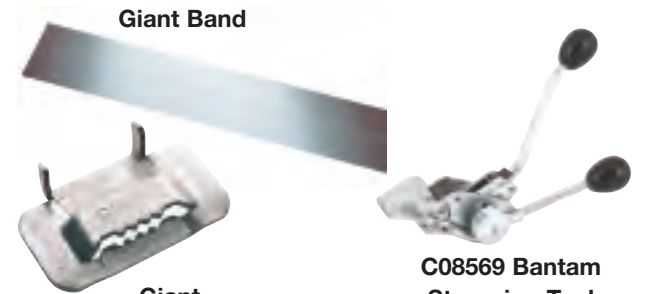

Giant Band

Giant Ear-Lokt Buckle

C08569 Bantam Strapping Tool

Hand Tools for Band and Buckle

Part No.	Description	Package Weight	
		Lbs.	Kg
C00169	BAND-IT® Tool - For band widths from 3/16" to 3/4"	4.3	1.8
C00369	BAND-IT® Heavy Duty Tool - For band widths from 3/16" to 3/4"	4.3	1.8
C07569	Bantam Tool Low torque - For band widths from 3/16" to 3/4"	2.6	1.1
C08569	Bantam strapping tool - Low torque for band widths from 3/16" to 3/4"	2.6	1.1
C40099	Ratchet Tool - For band widths from 3/16" to 3/4" Ratchet style alternative to C00169	3.3	1.4
G40269	Giant Tool - For use with only Giant Band from 3/4" to 1 1/4"	10.4	4.5
J02069	Pok-It II Tool with cutter - For band widths from 3/16" to 3/8" wide	0.8	0.3
J07599	Thriftool®, 10 Pack - Applies tension, 3/16" - 3/8" wide band, BAND-FAST™, BAND-IT Jr.® Clamps	5.9	2.7



G40269 Giant Tool



C40099 Ratchet Tool



J02069 Pok-It II Tool with Cutter

*BAND-IT reserves the right to substitute material with equal or better corrosion resistance and/or mechanical specifications.

Adjustable Clamping Systems

Worm Gear Clamp

Part No.	Material*	Width		Inside Diameter Range				Package Quantity	Package Weight		Application Tools
		In	mm	Min	Max	Min	Max		Lbs	Kg	
V20299	301 SS	5/16	7.9	1/4	5/8	6	16	10/box	0.2	0.1	Hex or Screw Driver
V20399	301 SS	5/16	7.9	3/8	7/8	8	23	10/box	0.2	0.1	
V00699	301 SS	9/16	14.3	3/8	7/8	9	22	10/box	0.5	0.2	
V00899	301 SS	9/16	14.3	1/2	1	11	25	10/box	0.5	0.2	
V01099	301 SS	9/16	14.3	1/2	1-1/8	12	28	10/box	0.6	0.3	
V01299	301 SS	9/16	14.3	1/2	1-1/4	12	32	10/box	0.6	0.3	
V01699	301 SS	9/16	14.3	3/4	1-1/2	19	38	10/box	0.6	0.3	
V02099	301 SS	9/16	14.3	7/8	1-3/4	22	45	10/box	0.6	0.3	
V02499	301 SS	9/16	14.3	1-1/8	2	28	51	10/box	0.7	0.3	
V02899	301 SS	9/16	14.3	1-3/8	2-1/4	35	57	10/box	0.7	0.3	
V03299	301 SS	9/16	14.3	1-5/8	2-1/2	41	64	10/box	0.8	0.3	
V03699	301 SS	9/16	14.3	1-7/8	2-3/4	48	70	10/box	0.8	0.4	
V04099	301 SS	9/16	14.3	2-1/8	3	54	76	10/box	0.8	0.4	
V04499	301 SS	9/16	14.3	2-3/8	3-1/4	58	83	10/box	0.9	0.4	
V04899	301 SS	9/16	14.3	2-5/8	3-1/2	67	89	10/box	0.9	0.4	
V05299	301 SS	9/16	14.3	2-7/8	3-3/4	73	95	10/box	0.9	0.4	
V05699	301 SS	9/16	14.3	3-1/8	4	79	102	10/box	1.0	0.4	
V06499	301 SS	9/16	14.3	3-1/2	4-1/2	89	114	10/box	1.1	0.5	
V07299	301 SS	9/16	14.3	4	5	102	127	10/box	1.3	0.6	
V08099	301 SS	9/16	14.3	4-1/2	5-1/2	114	140	10/box	1.3	0.6	
V08899	301 SS	9/16	14.3	5-1/8	6	130	152	10/box	1.4	0.6	
V10499	301 SS	9/16	14.3	6-1/8	7	155	178	10/box	1.5	0.7	



Worm Gear Clamp

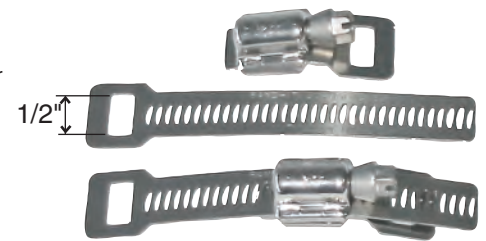

Scru-Seal Rack and Housing

Scru-Seal Clamping System

- A rack and pinion system used with band to create any size clamp.
- Components separately packaged rack and housing and band for flexibility.

Part No.	Material*	Description	Package Quantity	Package Weight	
				Lbs	Kg
M21199	SS	10 Scru-Seal racks and 10 Housings	10/box	0.7	0.3
C13399	SS	VALU-STRAP™ Band, SS, 3/8" x 0.015" x 100'	100'/roll	2.2	1.0
C13499	SS	VALU-STRAP™ Band, SS, 1/2" x 0.015" x 100'	100'/roll	2.9	1.3

Kits-Everything you need in a single package

M21099	SS	Scru-Seal Kit includes: 25 Scru-Seal racks, 25 housings, VALU-STRAP™ band 3/8" x 0.015" x 100'	each	4.3	1.9
M21899	SS	Each Clamp Pak includes: 3 Scru-Seal racks, 3 housings, VALU-STRAP™ band 3/8" x 0.015" x 10'	10 paks/box	5.0	2.3



M21899
Clamp-Pak
(Shipped as
10 pack)



M21099 Scru-Seal Kit
with VALU-STRAP™



Scru-Band
Clamping System

Scru-Band Clamping System

- A pinion and band with full length formed rack to create any size clamp.
- Components separately packaged rack and housing and band for flexibility.

Part No.	Material*	Description	Package Quantity	Package Weight	
				Lbs	Kg
M15099	SS	Scru-Band Housing, 301 SS-Screw 410 SS	100/box	2.8	1.3
M15599	SS	Scru-Band Housing, 301 SS-Screw 410 SS	25/box	0.7	0.3
M15199	SS	Scru-Band, 430SS 3/8" (9.5mm) x .025" (30.5M) (.64mm)	100'/roll	3.4	1.6

Kits-Everything you need in a single package

M15699	SS	Scru-Band Kit includes: 100' of Scru-Band, 25 housings, 25 slotted screws	each	4.0	1.8
M15799	SS	Scru-Band Kit includes: 50' of Scru-Band, 10 housings, 10 slotted screws	each	2.1	1.0
M15899	SS	Each Pak includes: 10' of Scru-Band, 5 housings, 5 slotted screws	10 paks/box	4.4	2.0



M15699, M15799
Scru-Band Kit



M15899
Scru-Band Pak
(Shipped as 10 pack)

*BAND-IT reserves the right to substitute material with equal or better corrosion resistance and/or mechanical specifications.

Brack-Its and Mounting Hardware

Brack-Its

- Used to mount traffic signs, security devices, and enclosures.
- Withstands stress and wind vibration with specially designed reinforcement ribs.
- Fully threaded to solidly anchor attachment bolts.
- Hex head bolts with metal and fiber washer, no nuts required.
- Applied with BAND-IT® Band and Buckles, VALU-STRAP™, VALU-STRAP Plus™, BAND-FAST™ or Ultra-Lok® Systems.

Mini Brack-It

Part No.	Description	Thickness		Package Quantity	Package Weight	
		In	mm		Lbs	Kg
D31099	Flared Leg mini-Brack-It, SS with SS bolt and fiber washer, 1/2" slot	0.050	1.27	50/box	3.0	1.5
D31599	Straight Leg mini-Brack-It, SS, with SS bolt and fiber washer, 1/2" slot	0.050	1.27	50/box	3.0	1.5
D30288	5/16-24 x 1/2" Hex Head SS bolt, washer and fiber washer for mini-Brack-It	-	-	50/box	1.0	0.5

Single Bolt Flared Leg Brack-It

Part No.	Description	Thickness		Package Quantity	Package Weight	
		In	mm		Lbs	Kg
D02189	Single bolt flared leg SS Brack-It with SS bolt, washer and fiber washer, 3/4" slot	0.070	1.78	50/box	7.0	3.2
D02299	Single bolt flared leg SS Brack-It only, 3/4" slot	0.070	1.78	50/box	5.5	7.5

Single Bolt Straight Leg Brack-It

Part No.	Description	Thickness		Package Quantity	Package Weight	
		In	mm		Lbs	Kg
D00189	Single bolt straight leg SS with SS bolt, washer and fiber washer, 3/4" slot	0.070	1.78	50/box	7.0	3.2
D00499	Single bolt straight leg SS Brack-It only, 3/4" slot	0.070	1.78	50/box	5.6	2.5

2-Bolt Brack-It

Part No.	Description	Thickness		Package Quantity	Package Weight	
		In	mm		Lbs	Kg
D00889	2 bolt straight leg SS Brack-It with SS Bolt, washer, and fiber washer, 3/4" slot	0.070	1.78	50/box	9.2	4.2
D00999	2 bolt straight leg SS Brack-It only, 3/4" slot	0.070	1.78	50/box	7.1	3.2

Bolts and Washers for Brack-Its

Part No.	Description	Package Quantity	Package Weight	
			Lbs	Kg
D00299	5/16"-18 x 3/4" Hex Head SS bolt, washer and fiber washer	50/ bag	1.3	0.6

L-Mount Right Angle Brack-It

Part No.	Description	Package Quantity	Package Weight	
			Lbs	Kg
D00799	L-Mount right angle Brack-It, 0.070" thick SS, includes two bolt holes suitable for 5/16" or 1/4" bolts. Solid anchor for signs mounted at right angle. Does not include bolts.	50/box	4.4	2.0



Mounting Plate

Part No.	Description	Package Quantity	Package Weight	
			Lbs	Kg
D51089	Mounting Plate, Aluminum, 1-1/2" (3.81 mm) x 4-3/4" (120.7mm) with a 2" long 5/8" plated bolt.	25/box	15.0	6.8
D51289	Mounting Plate, Aluminum, 1-1/2" x 5-1/4" with a 2" long 5/8" plated bolt.	25/box	21.3	9.6
D51389	Mounting Plate, Aluminum, 1-1/2" x 5-1/4" with a 3" long 5/8" plated bolt.	25/box	21.3	9.6

- Aluminum extruded plate with 5/8 - 11 x 2" (50.8mm) plated bolt and nut.
- Available in two different sizes.
- Band slot width 1.375" to accommodate a single or double wrap of our 1 1/4" wide x .044 thick Giant Band.



D51089 Mounting Plate

BAND-IT® Bolt/Clamp

Part No.	Description	Package Quantity	Package Weight	
			Lbs	Kg
D50089	Bolt/Clamp. Includes a 3/8-16 X 6.0" carriage bolt. Slot will accommodate 3/4" width Giant Band	50/box	23.7	10.8
D50489	Bolt/Clamp. Includes a 5/8-11 X 8.0" carriage bolt. Slot will accommodate 1-1/4" width Giant Band	25/box	33.0	15.0

- Aluminum extruded housing with plated carriage bolt, nut and washer.
- Can be used with Giant Band.



BAND-IT® Bolt/Clamp

Signal Mounts 1-1/2" NPT

Part No.	Description	Package Quantity	Package Weight	
			Lbs	Kg
D04099	Signal Mount, 1-1/2" NPT	25/box	19.4	8.8
D04599	Narrow Back Signal Mount, 1-1/2" NPT	25/box	18.3	8.3

- Attach to pole with 3/4" Ultra-Lok®, BAND-FAST™ or BAND-IT® Band.
- Radius of standard Signal Mount accommodates a large range of pole diameters.
- Narrow Back Signal Mount can be used on small diameter poles or for mounting on poles with flat surfaces.

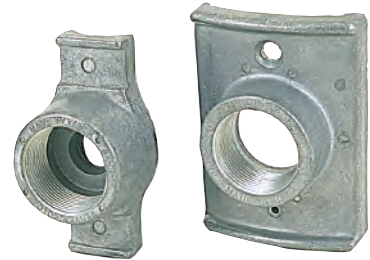

Signal Mounts

COLOR-IT™ Polyester

COLOR-IT™ coatings are available in a variety of colors and types providing superior performance and manufactured with your specific application in mind. Whether you are color-matching decorative light poles, identifying materials, or matching existing hardware on specific projects, COLOR-IT™ has the right coating for your project needs. Products coated with COLOR-IT™ work with standard banding tools.

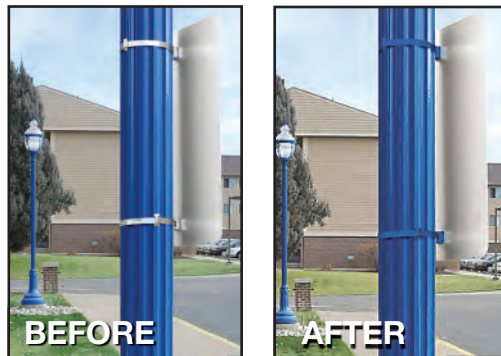

COLOR-IT™

BAND-IT Can Match Any Color. Call for Quote.

GARDEN HOSE AND FITTINGS



491C «aqua-gun»



92022	1/2" (13 mm)	25' (7.6 m)
92023	1/2" (13 mm)	50' (15.2 m)
92024	1/2" (13 mm)	100' (30.4 m)
92025	1/2" (13 mm)	500' (152 m)
92026	3/4" (19 mm)	25' (7.7 m)
92027	3/4" (19 mm)	50' (15.2 m)
92028	3/4" (19 mm)	100' (30.4 m)
92029	3/4" (19 mm)	500' (152 m)
92030	1" (25 mm)	500' (152 m)

PERFORATED HOSE



28250	Transparent	25' (7.6 m)
28400	Transparent	40' (12.2 m)
28500	Transparent	50' (15.2 m)
24250	Supersoak	25' (7.6 m)
24500	Supersoak	50' (15.2 m)



3 GAL SPRAYER



RUBBER WASHERS



MELNOR
No. 9538

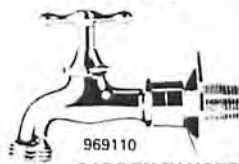

969110
GARDEN FAUCETS



MELNOR
No. 9535



BRASS FEM. GHT



BRASS MALE GHT



GILMORE
No. 572TFRL



MELNOR
No. 505C



3/4" NH (M) x 1/2" NPT (F)
3/4" NPT (M) x 3/4" NH (F)
3/4" NH (M) x 3/4" NPT (F)



3/4" NH x 1/2" NPT
3/4" NH x 3/4" NPT x 1/2" NPT (F)
3/4" NH x 3/4" NH



SWIVEL

R400-115 2" 1/2HP SUBMERSIBLE PUMP

- * Heavy duty 1/2HP CSA approved motor.
- * Unit easily fits into 8" casing.
- * Outer casing made of durable 304 stainless steel, making the pump easy to clean, keeping the weight down and preventing rust.
- * Impeller shaft, hardware and motor casing also made of 304 stainless steel.
- * The lip seal at the bottom of the oil chamber rides on a shaft sleeve, eliminating grooves forming on the shaft.
- * Lower silicon carbide seals are standard.
- * Top lid and oil housing are made of cast iron.
- * Double mechanical seals work in separate oil chamber.
- * Ideal for dewatering construction sites, mines, industrial and utility plants.
- * Also available with special high head impeller (Product #290772). See specifications for details.



R400D-115 1-1/2" 1/2 HP MOP-UP PUMP

- * Features a unique non-return valve built in just below the impeller, allowing the liquid to stay in the pump and pump line after shutdown!
- * This feature, along with rubber-clad pump bottom allows the unit to pump down to an incredible 1/12 of an inch!
- * Outer casing, motor housing, impeller shaft and hardware made of 304 stainless steel.
- * Double mechanical seals work in separate oil chamber.
- * An oi-seal ring has been installed under the oil chamber to prevent silt and sand from entering.



SV400-115 2" 1/2 HP SUBMERSIBLE TRASH PUMP

- * Heavy duty 1/2HP CSA approved motor.
- * Outer casing made of 304 stainless steel, making the pump fast to clean, keeping the weight down and preventing rust.
- * Impeller shaft, hardware and motor casing also made of 304 stainless steel.
- * The lip seal at the bottom of the oil chamber rides on a shaft sleeve, eliminating grooves forming on the shaft.
- * Lower silicon carbide seals are standard.
- * Double mechanical seals work in separate oil chamber.
- * Top lid and housing are made of cast iron.
- * Equipped with vortex type impellers, the best non-clog impellers available for the handling of mud, rain, sewage, viscuous liquids, rags, wood chips and other solids. Passes solids up to 90% of outlet diameter.



VORTEX IMPELLER



ALL PUMPS EQUIPPED WITH THERMAL OVERLOAD PROTECTION



The Way To Spray, Since 1884



Model 1046 - cleaner/deg 48oz



Model 22230 - acid sprayer 1gal/3.8L



Model 22240 - acid sprayer 2gal/7.6L



Model 21230 - poly sprayer 3 gal/11.4L



Model 22350 - cleaning/deg. 2gal/7.6L



Model 1949 - concrete 3.5gal/13.2L



Model 1380 - steel sprayer 3gal/11.4L



Model 60650 - Drum pump sprayer 55 gal.

SPARE PARTS FOR THESE MODELS

Model #	Description	Nozzle Assembly	Extension Wand	Sprayer Handle	Hose	Repair Kit
21230	Premier Poly Sprayer - 3G/11.4L	6-6000	6-7711	6-1866	6-6136	6-5368
1380	Premier Steel Sprayer - 3G	6-6000	6-7711	6-1866	6-6136	6-1925
1046	Industrial Viton Cleaner/Degreaser - 48oz	N/A	N/A	N/A	N/A	N/A
22230	Industrial Acid Staining Sprayer - 1G	6-5372	6-5370	6-5371	6-6136	6-5369
22240	Industrial Acid Staining Sprayer - 2G	6-5372	6-5370	6-5371	6-6136	6-5369
22350	Industrial Viton Cleaner/Degreaser - 2G	6-6003	6-7749	6-4638	6-6136	6-5368
1949	Industrial Viton Concrete Open Head - 3.5G	6-5797	6-7703	6-6062	6-6091	6-4627



Foam pigs 2" - 60" 51mm - 1524mm

Description

The foam pigs and spheres are fabricated from the highest quality open cell polyurethane foam. The flexible nature of these pigs allows for the negotiation of both short radius bends and unexpected reductions in pipe bore.

Features

The basic foam pig design can be adopted to include a variety of tough urethane coatings. The addition of aggressive wire brushes into the urethane coating provide a durable and efficient cleaner for hard pipe scale applications.

Foam pigs and spheres are the most cost effective, versatile design of pipeline cleaner in the market today. They are widely used in a complete range of applications such as :

- Gathering Systems;
- Municipal Water and Waste Management;
- Gas distribution;
- Petrochemical;
- Oil and gas.

Options



Handling Rope

Polypropylene rope for one or both ends of the pig for ease of handling.



Transmitter Cavity

Standard and customized cavity for encasing transmitters for pig tracking.



Double Dish

Ideal for bi-directional operations and evacuation of liquids.



Double Nose

Bi-directional operations, multi-diameter pipeline.



Foam balls

Bi-directional, short radius bends for drying, wiping and scraping.

*Custom designs and sizes are available.
Please contact Us for more detailed information.*

Heavy density

128 - 160 kg/m³ (8 - 10 lb/ft³)



HDBS
Heavy density
Bare squeegee
Heavy drying



HDCC
Heavy density
Criss Cross
Heavy wiping

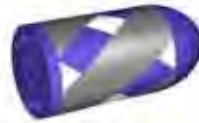

HDWB
Heavy density
Wire brush
Heavy scraping



HDSC
Heavy density
Silicone carbide
Heavy scraping

Medium density 80 - 112 kg/m³

(5 - 7 lb/ft³)



MDBS
Medium density
Bare squeegee
Regular drying



MDCC
Medium density
Criss Cross
Regular wiping



MDWB
Medium density
Wire brush
Regular scraping



MDSC
Medium density
Silicone carbide
Regular scraping

Light density
Bare squeegee
32 kg/m³
(2 lb/ft³)



LDBS
Light drying

Super light
Swabs
16 - 32 kg/m³
(1 - 2 lb/ft³)



SLS
Light drying

Total covered
Wire brush
128 - 160 kg/m³
(8 - 10 lb/ft³)



PORCUPINE
Maximum scraping

WIRE ROPES



Diameter in inches	6 × 25 FC		6 × 19 IWRC		8 × 19 IWRC		18 × 7 FC		6 × 41 FC		6 × 41 IWRC	
	B/L in tons	Mass lbs.ft.	B/L in tons	Mass lbs.ft.	B/L in tons	Mass lbs.ft.	B/L in tons	Mass lbs.ft.	B/L in tons	Mass lbs.ft.	B/L in tons	Mass lbs.ft.
3/16 (.188)	1.40	.06	1.60	.07								
1/4 (.250)	2.70	.10	2.90	.11	2.20	.10			2.40	.10	2.60	.11
5/16 (.313)	4.10	.16	4.40	.18	3.40	.15	3.80	.17	4.00	.16	4.30	.18
3/8 (.375)	6.00	.23	6.40	.25	5.10	.22	5.60	.24	5.50	.22	5.90	.24
7/16 (.438)	8.00	.31	8.60	.34	7.00	.30	7.60	.33	7.50	.30	8.00	.33
1/2 (.500)	10.60	.40	11.20	.44	9.00	.39	9.80	.43	10.00	.39	10.70	.43
9/16 (.563)	13.30	.51	14.30	.56	11.50	.50	12.40	.55	12.50	.49	13.40	.54
5/8 (.625)	16.50	.63	17.70	.69	14.10	.61	15.30	.68	15.60	.61	16.60	.67
3/4 (.750)	23.00	.90	25.50	.99	20.00	.88	21.80	.97	22.40	.87	23.80	.96
7/8 (.875)	32.00	1.23	34.40	1.35	27.00	1.20	29.50	1.32	30.20	1.19	32.40	1.31
1 (1.000)	41.70	1.60	44.80	1.76	35.00	1.57	38.30	1.73	39.50	1.55	42.40	1.70
1 1/8 (1.125)	53.00	2.03	56.00	2.23	44.30	1.99	48.00	2.19	49.00	1.96	52.60	2.16
1 1/4 (1.250)	65.50	2.50	70.40	2.75	54.50	2.45	59.00	2.70	61.00	2.42	65.50	2.66
1 3/8 (1.375)	81.00	3.03	87.00	3.33	65.50	2.97	71.00	3.27	74.50	2.93	80.00	3.22
1 1/2 (1.500)	96.00	3.60	103.20	3.96	78.00	3.53	84.00	3.89	90.00	3.49	96.70	3.84
1 5/8 (1.625)	113.00	4.23	121.40	4.65					105.50	4.09	113.40	4.50
1 3/4 (1.750)	130.00	4.90	139.70	5.39					121.00	4.75	130.00	5.23
1 7/8 (1.875)	152.00	5.63	163.40	6.19					142.00	5.45	152.60	6.00
2 (2.000)	169.00	6.40	181.60	7.04					155.00	6.20	166.60	6.82
2 1/4 (2.250)	210.00	8.10	225.70	8.91					201.00	7.85	216.00	8.64
2 1/2 (2.500)	260.00	10.00	279.50	11.00					245.00	9.69	263.30	10.70
2 3/4 (2.750)	305.00	12.10	327.80	13.31					293.00	11.72	315.00	12.90

Note:

The breaking load values in tons of 2000 lbs, and rope mass are those included in CSA standard G4, for grade 110/120 steel wire ropes.

This table includes the Wire Ropes generally used for slings and cranes, along with their breaking load and rope mass. The rope working load limit is calculated from these breaking loads using 10:1 working load factor for 18 × 7 construction and 5:1 for the remaining rope constructions.

WRI becket loops for easier installation

For ease in reeving heavy shovel ropes and special crane ropes. WRI is equipped to supply a flexible pulling loop secured to the end (or ends) of the rope by means of a steel sleeve.

This fitting is so designed that the end does not offer a greater diameter than the rope itself, thus facilitating ease of installation.



Ferrules

These are often required to anchor hoisting ropes to drums on small overhead electric and air powered hoists. Customers should supply the finished ferrule dimensions when ordering these items.



Welded and tapered terminations

Some customers require ropes with welded and tapered ends. We are equipped to supply these as required.



WIRE ROPES

Small Diameter Cables

Galvanized

Diameter	Weight (lbs/1000')	Nominal B/S (lbs)	Vanguard Code
7 x 7 Construction			
1/16	7.5	480	2701 0004
3/32	16.0	920	2701 0006
1/8	28.5	1,700	2701 0008
3/16	62.0	3,700	2701 0012
7 x 19 Construction			
3/32	16.0	1,000	2703 0006
1/8	29.0	2,000	2703 0008
5/32	45.0	2,800	2703 0010
3/16	65.0	4,200	2703 0012
1/4	110.0	7,000	2703 0016
5/16	173.0	9,800	2703 0020
3/8	243.0	14,400	2703 0024

Preformed Galvanized Cables are recommended whenever flexibility, high strength and fatigue resistance are required.

1 x 19



Designed primarily for standing rigging on boats, bracing and other applications where the stiffness of a strand is preferable to the flexibility of a cable.

7 x 7



Generally used for small diameters. Less flexible than 7 x 19, but better abrasion resistance.

7 x 19



Most flexible and widely used construction for a multitude of applications.

Stainless Steel

Diameter	Weight (lbs/1000')	Nominal B/S (lbs)	Vanguard Code
1 x 19 Construction			
1/16	8.5	500	2802 0004
3/32	20.0	1,200	2802 0006
1/8	35.0	2,100	2802 0008
5/32	55.0	3,300	2802 0010
3/16	77.0	4,700	2802 0012
7/32	102.0	6,300	2802 0014
1/4	135.0	8,200	2802 0016
9/32	170.0	10,300	2802 0018
5/16	210.0	12,500	2802 0020
3/8	317.0	17,100	2802 0024
7 x 7 Construction			
1/16	7.5	480	2801 0004
3/32	16.0	920	2801 0006
1/8	28.5	1,700	2801 0008
7 x 19 Construction			
3/32	16.0	1,050	2803 0006
1/8	29.0	1,760	2803 0008
5/32	45.0	2,400	2803 0010
3/16	65.0	3,700	2803 0012
1/4	110.0	6,400	2803 0016
5/16	173.0	9,000	2803 0020
3/8	243.0	12,000	2803 0024

Stainless Steel Cables offer an excellent combination of corrosion and fatigue resistance and high strength.

Type 302/304 - Standard Grade

Type 316 - Superior corrosion resistance



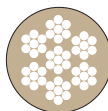

PVC and Nylon Coated Cables



Warning:



Working Load Limits will depend on the actual usage (NBS/Safety Margin)

Aircraft Cable and Preformed Strand

Galvanized					
Construction	Code *	Diameter in.	Minimum Breaking Strength lbs.	Weight per 100 ft lbs.	
Soft guy wire	11617SOFT	1/16	100	0.85	
	56417SOFT	5/64	150	1.4	
	33217SOFT	3/32	250	2.0	
	01817SOFT	1/8	520	3.3	
 1 x 7	16417G	1/64	40	0.055	
	13217G	1/32	185	0.23	
	36417G	3/64	375	0.55	
	11617G	1/16	500	0.85	
	56417G	5/64	800	1.4	
	33217G	3/32	1,200	2.0	
	01817G	1/8	2,100	3.5	
	01417GEHS	1/4	6,650	13.7	
	03817GEHS	3/8	15,400	24.3	
	01217GEHS	1/2	26,900	52.0	
	91617GEHS	9/16	35,000	67.0	
	 1 x 19	364119G	3/64	375	0.55
		116119G	1/16	500	0.85
		564119G	5/64	800	1.4
332119G		3/32	1,200	2.0	
018119G		1/8	2,100	3.3	
532119G		5/32	3,300	5.5	
316119G		3/16	4,700	7.7	
014119G		1/4	8,200	13.5	
516119G		5/16	12,500	21.0	
038119G		3/8	17,500	30.1	
 7 x 7	36477G	3/64	270	0.42	
	11677G	1/16	480	0.75	
	56477G	5/64	650	1.1	
	33277G	3/32	920	1.6	
	01877G	1/8	1,700	2.85	
	53277G	5/32	2,600	4.3	
	31677G	3/16	3,700	6.2	
	01477G	1/4	6,100	10.6	
	51677G	5/16	9,200	16.7	
	03877G	3/8	13,300	23.6	
 7 x 19	116719G	1/16	480	0.75	
	332719G	3/32	1,000	1.6	
	018719G	1/8	2,000	2.9	
	532719G	5/32	2,800	4.5	
	316719G	3/16	4,200	6.5	
	732719G	7/32	5,600	8.6	
	014719G	1/4	7,000	11.0	
	516719G	5/16	9,800	17.3	
	038719G	3/8	14,400	24.3	

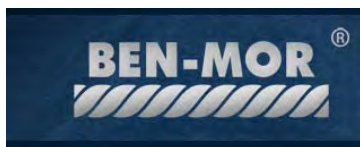
Miniature cable available on request (smaller than 1/32")







Black Oxide				
Construction	Code *	Diameter in.	Minimum Breaking Strength lbs.	Weight per 100 ft lbs.
 7 x 7	11677GBLO	1/16	480	0.75
 7 x 19	018719GBLO	1/8	2,000	2.9
	316719GBLO	3/16	4,200	6.5

Black oxide : Gives galvanized cable a black matte finish









Stainless Steel 304

Construction	Code *	Diameter in.	Minimum Breaking strength lbs.	Weight per 100 ft lbs.
 1 x 7	1641754	1/64	40	0.055
	1321754	1/32	185	0.23
	3641754	3/64	375	0.55
	1161754	1/16	500	0.85
	5641754	5/64	800	1.4
	3321754	3/32	1,200	2.0
	0181754	1/8	2,100	3.5
	3161754	3/16	4,700	7.3
	O1417S4EHS	1/4	8,500	13.7
	O3817S4EHS	3/8	18,000	24.3
O1217S4EHS	1/2	33,700	52.0	
 1 x 19	364119S4	3/64	375	0.55
	116119S4	1/16	500	0.85
	564119S4	5/64	800	1.4
	332119S4	3/32	1,200	2.0
	018119S4	1/8	2,100	3.3
	532119S4	5/32	3,300	5.5
	316119S4	3/16	4,700	7.7
	014119S4	1/4	8,200	13.5
	516119S4	5/16	12,500	21.0
	038119S4	3/8	17,500	30.1
012119S4	1/2	30,000	52.0	
 7 x 7	13277S4	1/32	120	0.16
	36477S4	3/64	270	0.42
	11677S4	1/16	480	0.75
	56477S4	5/64	650	1.1
	33277S4	3/32	920	1.6
	01877S4	1/8	1,700	2.85
	53277S4	5/32	2,400	4.3
	31677S4	3/16	3,700	6.2
	01477S4	1/4	6,100	10.6
	51677S4	5/16	9,000	16.7
03877S4	3/8	12,000	23.6	
01277S4	1/2	23,300	44.0	
 7 x 19	116719S4	1/16	480	0.75
	332719S4	3/32	920	1.6
	018719S4	1/8	1,760	2.9
	532719S4	5/32	2,400	4.5
	316719S4	3/16	3,700	6.5
	732719S4	7/32	5,000	8.6
	014719S4	1/4	6,400	11.0
	516719S4	5/16	9,000	17.3
038719S4	3/8	12,000	24.3	

Type 304 stainless steel is the standard alloy for use in wire rope and cable. It has about the same strength as galvanized rope or cable but is much more corrosion resistant. It can be used in most industrial atmospheres and has acceptable corrosion resistance when used in marine and salt water.



Stainless Steel 316

Construction	Code *	Diameter in.	Minimum Breaking strength lbs.	Weight per 100 ft lbs.
 1 x 7	01417S6EHS	1/4	7,650	13.7
	03817S6EHS	3/8	16,200	24.3
	01217S6EHS	1/2	30,200	52.0
 1 x 19	018119S6	1/8	1,780	3.3
	532119S6	5/32	2,800	5.5
	316119S6	3/16	4,000	7.7
	014119S6	1/4	6,900	13.5
	516119S6	5/16	10,600	21.0
	038119S6	3/8	14,800	30.1
 7 x 7	012119S6	1/2	27,000	52.0
	11677S6	1/16	360	0.75
	33277S6	3/32	700	1.6
	01877S6	1/8	1,360	2.85
	31677S6	3/16	2,875	6.2
 7 x 19	51677S6	5/16	7,600	16.7
	018719S6	1/8	1,300	2.9
	532719S6	5/32	2,000	4.5
	316719S6	3/16	2,900	6.5
	014719S6	1/4	4,900	11.0
516719S6	5/16	7,600	17.3	
038719S6	3/8	11,000	24.3	

Type 316 stainless steel is the standard high corrosion resistant steel for rope and cable. It is resistant to many chemicals in the pulp and paper, photographic, food processing and textile industries. It has the best pitting resistance in marine and salt water and can be used in temperatures up to 480°C (900°F).



6 X 19/26, 6 X 36/37 Steel Core — Fiber Core

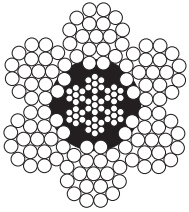

6 x 19

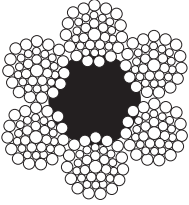

6 x 37

Diameter in.	Weight approx./ 100 ft lbs.	Minimum Breaking Strength — lbs					
		IPS				EIPS	
		Steel core		Fiber core		Steel core	
		Galv.	Bright	Galv.	Bright	Galv.	Bright
1/4	12	5,300	5,880	4,940	5,480	6,120	6,800
5/16	18	8,240	9,160	7,660	8,520	9,480	10,540
3/8	26	11,800	13,120	10,980	12,200	13,600	15,100
7/16	35	16,000	17,780	14,880	16,540	18,360	20,400
1/2	46	20,700	23,000	19,260	21,400	24,000	26,600
9/16	59	26,100	29,000	24,300	27,000	30,200	33,600
5/8	72	32,200	35,800	30,000	33,400	37,000	41,200
3/4	104	46,000	51,200	42,800	47,600	53,000	58,800
7/8	142	62,200	69,200	58,000	64,400	71,600	79,600
1	185	80,800	89,800	75,200	83,600	93,000	103,400
1 1/8	234	101,800	113,000	94,600	105,200	117,000	130,000
1 1/4	289	125,000	138,800	116,200	129,200	143,800	159,800
1 3/8	350	150,400	167,000	139,800	155,400	172,800	192,000
1 1/2	416	178,000	197,800	165,600	184,000	206,000	228,000

Cable larger than 1 1/2" available on request.



19 X 7 Non-rotating

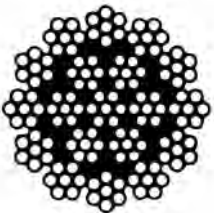

19 x 7

Code	Diameter in.	Weight per 100 ft lbs.	Minimum Breaking Strength lbs.	
			IPS	EIPS
014197B	1/4	11	5,020	5,460
516197B	5/16	18	7,800	8,530
038197B	3/8	25	11,180	12,300
716197B	7/16	35	15,160	16,660
012197B	1/2	45	19,700	21,600
916197B	9/16	58	24,800	27,200
058197B	5/8	71	30,600	33,600
034197B	3/4	102	43,600	48,000
078197B	7/8	139	59,000	65,000
001197B	1	182	76,600	84,400

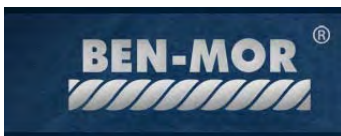

Cable Laid (Galvanized) 7 X 7 X 7

Code	Diameter in.	Minimum Breaking Strength lbs.	Weight per 100 ft lbs.
014777G	1/4	4,900	9
516777G	5/16	6,000	13
038777G	3/8	10,400	22
012777G	1/2	19,500	35
058777G	5/8	29,200	60
034777G	3/4	42,000	88
078777G	7/8	56,000	119
001777G	1	78,000	156

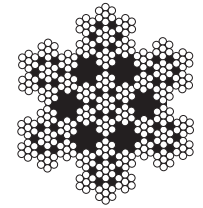

7 x 7 x 7

6 x 19/26 Stainless Steel



Diameter in.	Weight per 100 ft lbs.	Minimum Breaking Strength lbs.	
		GR. 304	GR. 316
7/16	36	16,300	15,000
1/2	46	22,800	19,300
9/16	59	28,500	24,300
5/8	72	35,000	29,800
3/4	92	49,600	42,000
7/8	143	66,500	58,000
1	187	85,400	80,000

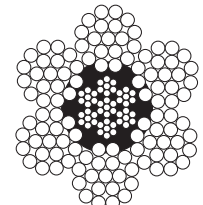

6 x 19

6 x 36/37 Stainless Steel



Diameter in.	Weight per 100 ft lbs.	Minimum Breaking Strength lbs.	
		GR. 304	GR. 316
1/4	10	5,400	4,800
5/16	18	8,300	7,470
3/8	24	11,700	10,530
7/16	33	15,800	14,200
1/2	43	20,400	18,360
9/16	54	25,600	21,760
5/8	67	31,400	28,260
3/4	96	44,400	39,960
7/8	131	59,700	53,730
1	170	77,300	69,570

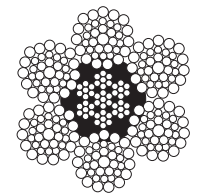

6 x 37

3 x 7 Swaged

Code	Diameter in.	Minimum Breaking Strength lbs.	Weight per 100 ft lbs.
31637BS	3/16	4,000	10



Armored Cable (tow target cable) 1 x 19

Code	Outside diameter in.	Inside diameter in.	Minimum Breaking Strength lbs.	Weight per 100 ft lbs.
0181164119A	11/64	1/8 galvanized	4,000	8



Chain Slings, Certified — Grade 80 (safety factor 4:1)

SINGLES



Type A



Type B



S00



S0F



S0G



S0S



SSG



SSS

DOUBLES

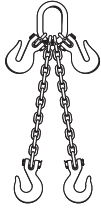

Type A



Type B



DOF



DOG



DOS

TRIPLES

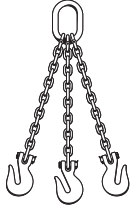

TOG



TOS

QUADRUPLES



QOG



QOS

Chain Diameter in.	Working Load Limit (lbs)				Oblong* Master Link
	Single @ 90 °	Double @ 60 °	Double @ 45 °	Double @ 30 °	
9/32	3,500	6,100	4,900	3,500	A342-012
3/8	7,100	12,300	10,000	7,100	A342-034
1/2	12,000	20,800	17,000	12,000	A342-001
5/8	18,100	31,300	25,600	18,100	A342-001
3/4	28,300	49,900	40,000	28,300	A342-114
7/8	34,200	59,200	48,400	34,200	A342-112
1	47,700	82,600	67,400	47,700	A342-134
1 1/4	72,300	125,200	102,200	72,300	A342-002

*See dimensions on page 63

Chain Diameter in.	Working Load Limit (lbs)			Oblong* Assemblies
	Triple / Quad @ 60 °	Triple / Quad @ 45 °	Triple / Quad @ 30 °	
9/32	9,100	7,400	5,200	SUB-034
3/8	18,400	15,100	10,600	SUB-001
1/2	31,200	25,500	18,000	SUB-114
5/8	47,000	38,400	27,100	SUB-112
3/4	73,500	60,000	42,400	SUB-134
7/8	88,900	72,500	51,300	SUB-002
1	123,900	101,200	71,500	SUB-214
1 1/4	187,800	153,400	108,400	SUB-234

*See dimensions on page 63

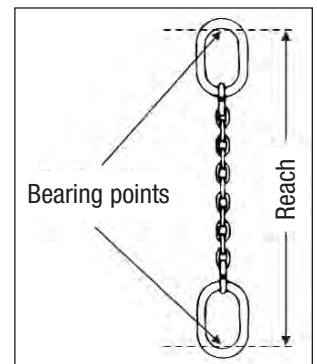

Hydraloc™ and Blu-Loc™ Slings

Rope size (in.)	Vertical lift	Choker hitch*	Basket hitch*	2 Part 60°	2 Part 90°	2 Part 120°
WRI 6 x 19 I.P.S. IWRC preformed						
¼	0.6	0.45	1.2	1.0	0.8	0.6
⅜	1.3	0.97	2.6	2.2	1.8	1.3
½	2.2	1.6	4.4	3.8	3.1	2.2
⅝	3.5	2.7	7.0	6.2	5.0	3.5
¾	5.0	3.8	10.0	8.9	7.1	5.0
⅞	7.0	5.2	14.0	12.0	9.6	7.0
1	9.0	6.7	18.0	16.0	13.0	9.0
WRI 6 x 37 I.P.S. IWRC preformed						
1⅛	11.0	8.0	22.0	18.0	15.0	11.0
1¼	13.0	9.8	26.0	23.0	18.0	13.0
1⅝	16.0	12.0	32.0	28.0	22.0	16.0
1½	19.0	14.0	38.0	34.0	27.0	19.0
1⅞	22.0	17.0	45.0	40.0	32.0	23.0
1¾	26.0	20.0	52.0	46.0	36.0	26.0
1⅞	30.0	23.0	61.0	52.0	43.0	30.0
2	33.0	25.0	66.0	57.0	47.0	33.0
2¼	43.0	32.0	86.0	74.0	61.0	43.0
2½	52.0	39.0	105.0	91.0	74.0	52.0
2¾	63.0	47.0	126.0	109.0	89.0	63.0
3	75.0	56.0	150.0	130.0	106.0	75.0

* Rated capacities based on minimum curvature of 20XD at rope/load contact points.

Note: All calculated on the basis of 5:1 working load factor, and based on the use of Wire Rope Industries 6 x 19 regular lay preformed improved plow steel with independent wire rope centre for sizes from ¼" diameter to 1" diameter inclusive, and Wire Rope Industries 6 x 37 classification regular lay preformed improved plow steel with independent wire rope centre for diameters beyond 1".

CAUTION DO NOT EXCEED RATED CAPACITIES.

Alloy Chain Slings

This table gives the working load limits of 9/32" through 1" Peer-Alloy chain in one, two, three and four leg styles. Use this table as a guide to determine which chain sizes and leg styles are best for your requirements. Using the maximum load (or loads) you will lift, and the angle of lift required — work to the left across this table to determine proper chain size for your sling. Working load limit of the chain and components is established as pounds applied at the indicated degrees from horizontal.

Chain Trade Size, Inches	Single Branch Sling	Double Branch Sling			Triple Branch Sling			Quadruple Branch Sling		
	90°	60°	45°	30°	60°	45°	30°	60°	45°	30°
9/32	4,100	7,100	5,800	4,100	10,500	8,700	6,150	10,600	8,700	6,150
5/16	5,100	8,800	7,200	5,100	13,200	10,800	7,600	13,200	10,800	7,600
3/8	7,300	12,600	10,300	7,300	19,000	15,500	11,000	19,000	15,500	11,000
1/2	13,000	22,500	18,400	13,000	33,500	27,500	19,500	33,500	27,500	19,500
5/8	20,300	35,000	28,500	20,300	53,000	43,000	30,500	53,000	43,000	30,500
3/4	29,300	50,500	41,500	29,300	76,000	62,000	44,000	76,000	62,000	44,000
7/8	39,900	69,000	56,500	39,900	104,000	85,000	60,000	104,000	85,000	60,000
1	52,100	90,000	74,000	52,100	135,000	110,000	78,000	135,000	110,000	78,000

* These limits must not be exceeded. Manufacturers do not accept any liability for damages which may result from chain



G-450



G-335



G-340



G-341



S-247



A-336



G-209



G-210



G-401



G-402



G-403



G-2130



G-2150



S-1



S-2



S-3



S-4



S-5



S-6



320



320N



A-350



322-AN



G-3315



A-378



H-323



H-330



S-377



H-324



H-331



S-4320



SS-4055



G-414



S-412



HG-223



HG-225



HG-226



HG-227



HG-228



G-291



S-279



G-277



G-400



S-264



G-416



G-417



S-421T

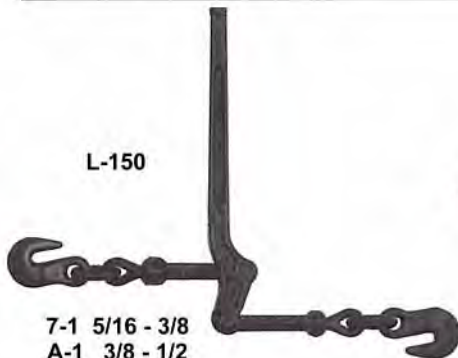

L-150

7-1 5/16 - 3/8
A-1 3/8 - 1/2
C-1 1/2 - 5/8



L-150

7-12 5/16 - 3/8
A-12 3/8 - 1/2



L-140

R-7 5/16 - 3/8
R-7 QL 5/16 - 3/8
R-A 3/8 - 1/2
R-C 1/2 - 5/8



GRADE 30



GRADE 40



GRADE 70



GRADE 80



418



430



416



420



C-700



C-720



408



419



431



409



404



601-S



602-S



600-S



603-S



461



463



HS-21-C
HS-21-B
HS-21-R



N-22 R
N-22 B



S-23 B



HS-261-C
HS-261-B
HS-261-R



HS-262-C
HS-262-B



HS-263-C
HS-263-B



T-385 B
T-385 C
T-385 R



T-386 B



T-350 C
T-350 R
T-350 B



1101 1111

crosby shackles

Crosby® Round Pin Shackles

Screw Pin Anchor Shackles



- Capacities 1/3 through 55 metric tons.
- Forged - quenched and tempered, with alloy pin.
- working load limit permanently shown on every shackle.
- Hot dip galvanised or self-coloured.
- Fatigue Rated. Shackles can be furnished proof tested with certificates to designated standards, such as ABS, DNV, Lloyds or other certification. Charges for proof testing and certification available when requested at the time of order.
- Shackles are quenched and tempered and can meet DNV impact requirements of 42 joules at -20C.

Screw Pin Chain Shackles



Nominal Size Inches	Working load limit Tonnes	Stock No.		Weight kgs	Dimensions mm													Tolerance +/-	
		G209	S209		A	B	C	D	E	F	G	H	L	M	P	C	A		
3/16	1/3	1018357	-	0.03	9.65	6.35	22.4	4.85	15.2	14.2	24.9	37.3	4.06	28.4	4.85	1.50	1.50		
1/4	1/2	1018375	1018384	0.05	11.9	7.85	28.7	6.35	19.8	15.5	32.5	46.7	4.85	35.1	6.35	1.50	1.50		
5/16	3/4	1018393	1018400	0.09	13.5	9.65	31.0	7.85	21.3	19.1	37.3	53.0	5.60	42.2	7.85	3.30	1.50		
3/8	1	1018419	1018428	0.14	16.8	11.2	36.6	9.65	26.2	23.1	45.2	63.0	6.35	51.5	9.65	3.30	1.50		
7/16	1 1/2	1018437	1018446	0.17	19.1	12.7	42.9	11.2	29.5	26.9	51.5	74.0	7.85	6.5	11.2	3.30	1.50		
1/12	2	1018455	1018464	0.33	20.6	16.0	47.8	12.7	33.3	30.2	58.5	83.5	9.65	68.5	12.7	3.30	1.50		
5/8	3 1/4	1018473	1018482	0.62	26.9	19.1	60.5	16.0	42.9	38.1	74.5	106	11.2	85.0	17.5	6.35	1.50		
3/4	4 3/4	1018491	1018507	1.07	31.8	22.4	71.5	19.1	51.0	46.0	89.0	126	12.7	101	20.6	6.35	1.50		
7/8	6 1/2	1018516	1018525	1.64	36.6	25.4	84.0	22.4	58.0	53.0	102	148	12.7	114	24.6	6.35	1.50		
1	8 1/2	1018534	1018543	2.28	42.9	28.7	95.5	25.4	68.5	60.5	119	167	14.2	129	26.9	6.35	1.50		
1 1/8	9 1/2	1018552	1018561	3.36	46.0	31.8	108	29.5	74.0	68.5	131	190	16.0	142	37.8	6.35	1.50		
1 1/4	12	1018570	1018589	4.31	51.5	35.1	119	32.8	82.5	76.0	146	210	17.5	156	35.1	6.35	1.50		
1 3/8	13 1/2	1018598	1018605	6.14	57.0	38.1	133	36.1	92.0	84.0	162	233	19.1	174	38.1	6.35	3.30		
1 1/2	17	1018614	1018623	7.80	60.5	41.4	146	39.1	98.5	92.0	175	254	20.6	187	41.1	6.35	3.30		
1 3/4	25	1018632	1018641	12.6	73.0	51.0	178	46.7	127	106	225	313	25.4	231	57.0	6.35	3.30		
2	35	1018650	1018669	20.4	82.5	57.0	197	53.0	146	122	253	348	31.0	263	61.0	6.35	3.30		
2 1/2	55	1018678	1018687	38.9	105	70.0	267	69.0	184	145	327	453	35.1	330	79.5	6.35	6.35		

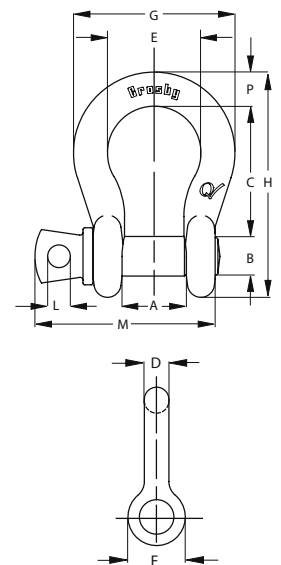

Nominal Size Inches	Working load limit Tonnes	Stock No.		Weight kgs	Dimensions mm													Tolerance +/-	
		G210	S210		A	B	C	D	E	F	G	K	L	M	A	A			
1/4	1/2	1019150	1019169	0.05	11.9	7.85	6.35	6.35	24.6	15.5	22.4	40.4	4.85	35.1	1.50	1.50			
5/16	3/4	1019178	1019187	0.08	13.5	9.65	7.85	7.85	29.5	19.1	26.2	48.5	5.60	42.2	1.50	1.50			
3/8	1	1019196	1019203	0.13	16.8	11.2	9.65	9.65	35.8	23.1	31.8	58.5	6.35	51.5	3.30	1.50			
7/16	1 1/2	1019212	1019221	0.20	19.1	12.7	11.2	11.2	41.4	26.9	36.6	67.5	7.85	60.5	3.30	1.50			
1/2	2	1019230	1019249	0.2	20.6	16.0	12.7	12.7	46.0	30.2	41.4	77.0	9.65	68.5	3.30	1.50			
5/8	3 1/4	1019258	1019267	0.57	26.9	19.1	15.7	16.0	58.5	38.1	51.0	95.5	11.2	85.0	3.30	1.50			
3/4	4 3/4	1019276	1019285	1.20	31.8	22.4	20.6	19.1	70.0	46.0	60.5	115	12.7	101	6.35	1.50			
7/8	6 1/2	1019294	1019301	1.43	36.6	25.4	24.6	22.4	81.0	53.0	71.5	135	12.7	114	6.35	1.50			
1	8 1/2	1019310	1019329	2.15	42.9	28.7	25.4	25.4	93.5	60.5	81.0	151	14.2	129	6.35	1.50			
1 1/8	9 1/2	1019338	1019347	3.06	46.0	31.8	31.8	28.7	103	68.5	91.0	172	16.0	142	6.35	1.50			
1 1/4	12	1019356	1019365	4.11	51.5	35.1	35.1	31.8	115	76.0	100	191	17.5	156	6.35	3.30			
1 3/8	13 1/2	1019374	1019383	5.28	57.0	38.1	38.1	35.1	127	84.0	111	210	19.1	174	6.35	3.30			
1 1/2	17	1019392	1019409	7.23	60.5	41.4	41.1	38.1	137	92.0	122	230	20.6	187	6.35	3.30			
1 3/4	25	1019418	1019427	12.1	73.0	51.0	54.0	44.5	162	103	146	279	25.4	231	6.35	3.30			
2	35	1019436	1019445	19.2	82.5	57.0	60.0	51.0	184	122	172	312	31.0	263	6.35	3.30			
2 1/2	55	1019454	1019463	32.5	105	70.0	66.5	66.5	238	145	203	377	35.1	330	6.35	6.35			

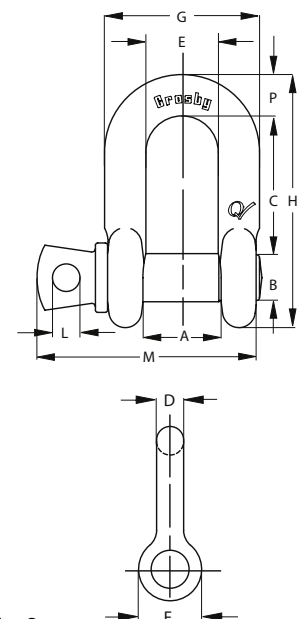

* NOTE: Maximum Proof Load is 2 times the working load limit. Minimum Ultimate Strength is 6 times the working load limit. For working load limit reduction due to side loading applications

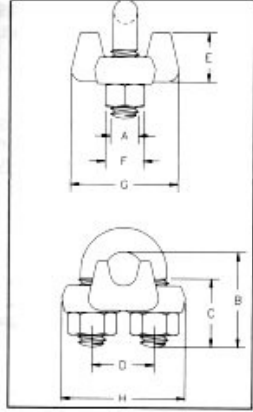

G-450 Crosby Clips

Rope Size (in.)	G-450 Stock No. Galv.	Std. Package Qty.	Weight Per 100 (lbs.)	Dimensions							
				A	B	C	D	E	F	G	H
*1/8	1010015	100	6	.22	.72	.44	.47	.41	.38	.81	.94
*3/16	1010033	100	10	.25	.97	.56	.59	.50	.44	.94	1.16
1/4	1010051	100	19	.31	1.03	.50	.75	.66	.56	1.19	1.44
5/16	1010079	100	28	.38	1.38	.75	.88	.72	.69	1.31	1.69
3/8	1010097	100	48	.44	1.50	.75	1.00	.91	.75	1.63	1.94
7/16	1010113	50	78	.50	1.88	1.00	1.19	1.03	.88	1.81	2.28
1/2	1010131	50	80	.50	1.88	1.00	1.19	1.13	.88	1.91	2.28
9/16	1010159	50	109	.56	2.25	1.25	1.31	1.22	.94	2.06	2.50
5/8	1010177	50	110	.56	2.38	1.25	1.31	1.34	.94	2.06	2.50
3/4	1010195	25	142	.62	2.75	1.44	1.50	1.41	1.06	2.25	2.84
7/8	1010211	25	212	.75	3.12	1.62	1.75	1.59	1.25	2.44	3.16
1	1010239	10	252	.75	3.50	1.81	1.88	1.78	1.25	2.63	3.47
1-1/8	1010257	10	283	.75	3.88	2.00	2.00	1.91	1.25	2.81	3.59
1-1/4	1010275	10	438	.88	4.25	2.13	2.31	2.19	1.44	3.13	4.13
1-3/8	1010293	10	442	.88	4.63	2.31	2.38	2.31	1.44	3.13	4.19
1-1/2	1010319	10	544	.88	4.94	2.38	2.59	2.44	1.44	3.41	4.44
1-5/8	1010337	Bulk	704	1.00	5.31	2.62	2.75	2.66	1.63	3.63	4.75
1-3/4	1010355	Bulk	934	1.13	5.75	2.75	3.06	2.94	1.81	3.81	5.28
2	1010373	Bulk	1300	1.25	6.44	3.00	3.38	3.28	2.00	4.44	5.88
2-1/4	1010391	Bulk	1600	1.25	7.13	3.19	3.88	3.19	2.00	4.50	6.38
2-1/2	1010417	Bulk	1900	1.25	7.69	3.44	4.13	3.69	2.00	4.05	6.63
** 2-3/4	1010435	Bulk	2300	1.25	8.31	3.56	4.38	4.88	2.00	5.00	6.88
3	1010453	Bulk	3100	1.50	9.19	3.88	4.75	4.69	2.38	5.88	7.63
** 3-1/2	1010426	Bulk	4000	1.50	10.75	4.50	5.50	6.00	2.38	6.19	8.38

*Electro-plated U-Bolt and Nuts. ** 2-3/4" and 3-1/2" base is made of cast steel.



THE TERMINATOR™ Crosby's "New & Improved" Wedge Socket



Wire Rope Size (in.)	S-421T Stock No. Complete Assembly *	S-421T Weight Each (lbs.)	S-421 TW Stock No. Wedge Only	S-421TW Weight Each (lbs.)
3/8	1035000	3.18	1035555	.50
1/2	1035009	6.15	1035564	1.05
5/8	1035018	9.70	1035573	1.79
3/4	1035027	14.50	1035582	2.60
7/8	1035036	21.50	1035591	4.02
1	1035045	30.75	1035600	5.37
1-1/8	1035054	45.30	1035609	7.84
**1-1/4	1040448	57.50	1040607	6.81

* Terminator Assembly includes Socket, Wedge, Pin, and Wire Rope Clip.
** 1-1/4" not available in **TERMINATOR™** style.

Wedge sockets meet the performance requirements of Federal Specification RR-S550D, Type C, except those provisions required of the contractor.

Wire Rope Dia. ‡ (in.)	Dimensions (in.)														
	A	B	C	D	G	H	J†	K†	L	P	R	S	T	U	V
3/8	5.63	2.77	.81	.81	1.38	3.12	7.38	1.60	.88	1.56	.44	2.13	.44	1.25	1.38
1/2	6.81	3.55	1.00	1.00	1.62	3.85	8.75	1.21	1.06	1.94	.50	2.44	.53	1.75	1.88
5/8	8.16	4.36	1.25	1.19	2.12	4.58	10.34	1.64	1.22	2.25	.56	3.13	.69	2.00	2.19
3/4	9.78	4.81	1.50	1.38	2.44	5.37	12.03	2.17	1.40	2.62	.66	3.63	.78	2.34	2.56
7/8	11.16	4.65	1.75	1.63	2.69	6.28	14.00	2.22	1.66	3.12	.75	4.19	.88	2.69	2.94
1	12.75	5.08	2.00	2.00	2.56	7.02	15.86	2.71	2.00	3.75	.88	4.63	1.03	2.88	3.28
1-1/8	14.38	5.51	2.25	2.25	3.31	7.76	17.70	2.50	2.25	4.25	1.00	5.38	1.19	3.13	3.56
1-1/4	16.00	7.94	2.50	2.50	3.56	N/A	N/A	3.39	2.50	4.75	1.12	5.81	1.31	3.38	3.81

† Nominal

‡ For intermediate rope sizes, use next larger size socket.

SHACKLES

'Golden Pin'®

Screw Pin Anchor Shackles

- Meeting the performance requirements of U.S. Fed. Spec. RR-C-271D, Type 4A, Grade A, Class 2

Size	Pin Diameter	Dimensions (inches)				WLL (tons)	Weight (lbs)	Vanguard Code
		A	B	C	D			
3/16	1/4	0.93	0.39	0.59	0.64	1/3	0.06	2902 0012
1/4	5/16	1.14	0.49	0.70	0.75	1/2	0.12	2902 0016
5/16	3/8	1.23	0.53	0.83	0.80	3/4	0.18	2902 0020
3/8	7/16	1.41	0.69	0.98	1.01	1	0.32	2902 0024
7/16	1/2	1.70	0.72	1.06	1.13	1 1/2	0.45	2902 0028
1/2	5/8	1.83	0.83	1.18	1.25	2	0.68	2902 0032
5/8	3/4	2.36	1.06	1.55	1.67	3 1/4	1.36	2902 0040
3/4	7/8	2.76	1.24	1.78	1.98	4 3/4	2.24	2902 0048
7/8	1	3.29	1.42	2.09	2.25	6 1/2	3.50	2902 0056
1	1 1/8	3.69	1.75	2.35	2.66	8 1/2	5.00	2902 0100
1 1/8	1 1/4	4.23	1.80	2.71	2.79	9 1/2	7.65	2902 0108
1 1/4	1 3/8	4.63	2.12	3.01	3.15	12	10.40	2902 0116
1 3/8	1 1/2	5.17	2.30	3.32	3.60	13 1/2	13.80	2902 0124
1 1/2	1 5/8	5.67	2.39	3.63	3.85	17	17.90	2902 0132
1 3/4	2	7.06	2.96	4.23	4.99	25	27.90	2902 0148
2	2 1/4	7.75	3.31	5.11	5.59	35	42.70	2902 0200
2 1/2	2 7/10	10.25	4.00	5.75	7.00	55	85.00	2902 0232

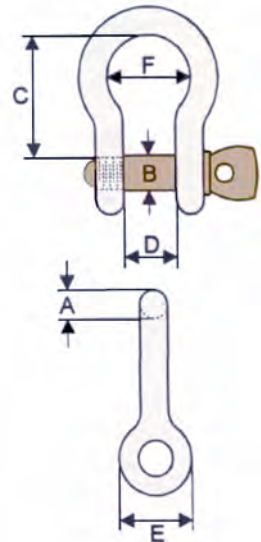

'Golden Pin'®

Screw Pin Chain Shackles

- Meeting the performance requirements of U.S. Fed. Spec. RR-C-271D, Type 4B, Grade A, Class 2

Size	Pin Diameter	Dimensions (inches)			WLL (tons)	Weight (lbs)	Vanguard Code
		A	B	E			
1/4	5/16	0.83	0.47	0.71	1/2	0.11	3912 0016
5/16	3/8	0.98	0.47	0.75	3/4	0.17	3912 0020
3/8	7/16	1.22	0.63	0.96	1	0.24	3912 0024
7/16	1/2	1.50	0.75	1.06	1 1/2	0.40	3912 0028
1/2	5/8	1.61	0.83	1.22	2	0.59	3912 0032
5/8	3/4	2.01	1.10	1.57	3 1/4	1.20	3912 0040
3/4	7/8	2.41	1.25	1.81	4 3/4	2.20	3912 0048
7/8	1	2.80	1.42	2.13	6 1/2	3.20	3912 0056
1	1 1/8	3.15	1.77	2.36	8 1/2	4.80	3912 0100
1 1/8	1 1/4	3.50	1.85	2.69	9 1/2	6.80	3912 0108
1 1/4	1 3/8	3.97	2.05	3.00	12	9.00	3912 0116
1 1/2	1 5/8	4.80	2.39	3.68	17	16.00	3912 0132
2	2 1/4	6.75	3.25	5.00	35	36.00	3912 0200

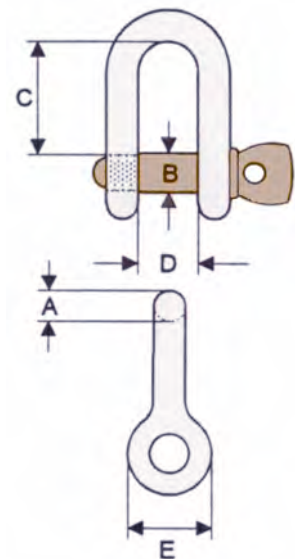

Note:

If the pin, after a 1/4 turn, remains hard to remove, there is a good chance that the shackle has been overloaded beyond the designed working load limit (WLL) and it, therefore, must be discarded.



Forged Turnbuckles

- Meeting the requirements of U.S. Fed. Spec. FF-T-791B Type 1, Form 1 (open body)
- Hexagon heads forged into bodies permit fast and easy adjustments
- Forged Carbon Steel, hot dip galvanized, end-fitting quenched & tempered
- Design Factor 5:1
- Available in various configurations (see Prefix*)

Size (Diameter x Take-Up)		Overall Dimension (closed)	WLL (lbs)		Weight (lbs)			Vanguard Suffix Code*
Diameter	Take-Up		H & H H & E	E & E J & J J & E	Eyes or Hooks	Jaw & Eye	Jaw & Jaw	
3/8	6	11 7/8	1,000	1,200	0.71	0.76	0.81 1024
1/2	6	13 5/16	1,500	2,200	1.45	1.53	1.61 1032
1/2	9	16 5/16	1,500	2,200	1.68	1.71	1.74 2032
1/2	12	19 5/16	1,500	2,200	2.00	2.06	2.11 3032
5/8	6	15 1/2	2,250	3,500	2.35	2.35	3.02 1040
5/8	9	18 1/2	2,250	3,500	2.88	3.06	2.88 2040
5/8	12	21 1/2	2,250	3,500	3.78	3.78	3.38 3040
3/4	6	17	3,000	5,200	3.64	3.87	4.11 1048
3/4	9	20	3,000	5,200	4.31	4.30	5.10 2048
3/4	12	23	3,000	5,200	5.08	5.36	5.65 3048
3/4	18	29	3,000	5,200	6.29	6.57	6.86 4048
7/8	12	24 5/8	4,000	7,200	7.35	7.76	8.17 3056
7/8	18	30 5/8	4,000	7,200	9.35	9.24	9.13 4056
1	12	26 5/8	5,000	10,000	11.23	11.20	11.18 3100
1	18	32 5/8	5,000	10,000	13.23	13.30	14.60 4100
1	24	38 5/8	5,000	10,000	16.58	16.30	17.30 5100
1 1/4	12	29 7/8	5,000	15,200	17.90	19.40	20.91 3116
1 1/4	18	35 7/8	5,000	15,200	22.85	24.18	25.50 4116
1 1/2	12	32 3/8	7,500	21,400	27.94	28.99	30.05 3132
1 1/2	18	38 3/8	7,500	21,400	33.19	33.38	31.56 4132
1 1/2	24	44 3/8	7,500	21,400	37.69	39.18	40.67 5132
2	24	51 3/4		37,000	89.90	94.60	100.00 5200



'Golden U-Bolt'®

Forged Wire Rope Clips

- Fed. Spec. FF-C-450, Type 1, Class 1
- Forged saddles, H.D. galvanized
- Gold chromated U-Bolts and Nuts identify 'Vanguard' product
- Torque tested threads
- Eye terminations reaching 80% of the rope strength when properly installed.



Rope Diameter	Min. No. of Clips	Rope turn-back	Torque (ft lbs)	Weight (lbs/100)	Dimensions (inches)							Vanguard Code
					A	B	C	D	E	F	G	
1/8	2	3 1/4	4.5	6	0.20	0.75	0.54	0.41	0.48	0.80	0.90	2907 0008
3/16	2	3 3/4	7.5	10	0.24	0.98	0.65	0.56	0.55	0.95	1.16	2907 0012
1/4	2	4 3/4	15.0	19	0.30	1.06	0.67	0.78	0.67	1.18	1.54	2907 0016
5/16	2	5 1/2	30.0	29	0.37	1.35	0.80	0.84	0.77	1.33	1.65	2907 0020
3/8	2	6 1/2	45.0	44	0.42	1.50	0.81	0.96	0.98	1.55	1.92	2907 0024
1/2	3	11 1/2	65.0	73	0.48	1.83	1.10	1.12	1.19	1.91	2.29	2907 0032
5/8	3	12	95.0	102	0.54	2.40	1.22	1.38	1.33	2.05	2.50	2907 0040
3/4	4	18	130.0	142	0.61	2.84	1.51	1.51	1.40	2.25	2.82	2907 0048
7/8	4	19	225.0	212	0.73	3.10	1.79	1.73	1.60	2.41	3.16	2907 0056
1	5	26	225.0	255	0.73	3.58	1.80	1.85	1.77	2.64	3.44	2907 0100
1 1/8	6	34	225.0	280	0.73	3.90	2.09	1.95	1.95	2.74	3.52	2907 0108
1 1/4	7	37	360.0	437	0.86	4.26	2.13	2.37	2.31	3.14	4.11	2907 0116
1 1/2	7	48	360.0	531	0.86	4.78	2.42	2.53	2.51	3.35	4.41	2907 0132
1 3/4	7	53	590.0	980	1.09	5.64	2.85	3.10	2.94	3.82	5.28	2907 0148
2	8	71	750.0	1,375	1.20	6.75	3.11	3.31	3.31	4.41	5.86	2907 0200

Grade 30 PROOF COIL CHAIN

Chain Size		Material Diameter		WLL (maximum)		Proof Test (minimum)		Breaking Force (minimum)		Inside Length (maximum)		Inside Width (minimum)	
inch	mm	inch	mm	lbs	kg	lbs	kN	lbs	kN	inch	mm	inch	mm
1/8	4.0	0.156	4.0	400	180	800	3.6	1,600	7.20	0.94	23.90	0.25	6.40
3/16	5.5	0.217	5.5	800	365	1,600	7.2	3,200	14.40	0.98	24.80	0.30	7.70
1/4	7.0	0.276	7.0	1,300	580	2,600	11.6	5,200	23.20	1.24	31.50	0.38	9.80
5/16	8.0	0.331	8.4	1,900	860	3,800	16.9	7,600	33.80	1.29	32.80	0.44	11.20
3/8	10.0	0.394	10.0	2,650	1,200	5,300	23.6	10,600	47.20	1.38	35.00	0.55	14.00
7/16	11.9	0.488	11.9	3,700	1,680	7,400	32.9	14,800	65.80	1.64	41.60	0.65	16.60
1/2	13.0	0.512	13.0	4,500	2,030	9,000	40.0	18,000	80.00	1.79	45.50	0.72	18.20
5/8	16.0	0.630	16.0	6,900	3,130	13,800	61.3	27,600	122.60	2.20	56.00	0.79	20.00
3/4	20.0	0.787	20.0	10,600	4,800	21,200	94.3	42,400	188.60	2.76	70.00	0.98	25.00
7/8	22.0	0.866	22.0	12,800	5,810	25,600	114.1	51,200	228.20	3.03	77.00	1.08	27.50
1	26.0	1.020	26.0	17,900	8,140	35,800	159.1	71,600	318.20	3.58	90.90	1.25	31.70

Grade 70 TRANSPORT CHAIN

Chain Size		Material Diameter		WLL (maximum)		Proof Test (minimum)		Breaking Force (minimum)		Inside Length (maximum)		Inside Width (minimum)	
inch	mm	inch	mm	lbs	kg	lbs	kN	lbs	kN	inch	mm	inch	mm
1/4	7.0	0.281	7.0	3,150	1,430	6,300	28.0	12,600	56.00	1.24	31.50	0.38	9.80
5/16	8.7	0.343	8.7	4,700	2,130	9,400	41.8	18,800	83.60	1.29	32.80	0.44	11.20
3/8	10.0	0.406	10.3	6,600	2,990	13,200	58.7	26,400	117.40	1.38	35.00	0.55	14.00
7/16	11.9	0.468	11.9	9,000	3,970	17,500	77.8	35,000	155.40	1.64	41.60	0.65	16.60
1/2	13.0	0.531	13.5	11,300	5,130	22,600	100.4	45,200	200.80	1.79	45.50	0.72	18.20
5/8	16.0	0.630	16.0	15,800	7,170	31,600	140.4	63,200	280.80	2.20	56.00	0.79	20.00
3/4	20.0	0.787	20.0	24,700	11,200	49,400	219.6	98,800	439.20	2.76	70.00	0.98	25.00

Warning:

THESE CHAINS MUST NOT BE USED IN OVERHEAD LIFTING APPLICATIONS
 Proof Test and Minimum Breaking Force Loads must not be used as criteria for service or design purposes

Grade 80 Chain



Chain Size	WLL (lbs)	Material Diameter	Inside Length	Inside Width	Weight (lbs/100')	Full drums		Vanguard Code
						feet	lbs	
9/32	3,500	0.275	0.880	0.410	72	800	576	3808 00161
5/16	4,500	0.330	1.020	0.480	106	500	530	3808 00201
3/8	7,100	0.397	1.220	0.570	150	400	600	3808 00241
1/2	12,000	0.520	1.560	0.750	261	200	522	3808 00321
5/8	18,100	0.630	1.930	0.920	361	150	542	3808 00401
3/4	28,300	0.790	2.360	1.020	610	196	1,195	3808 00481
7/8	34,200	0.870	2.600	1.130	720	164	1,181	3808 00561
1	47,700	1.020	3.070	1.330	1,025	98	1,005	3808 01001

Grade 100 Chain

Chain Size	WLL (lbs)	Material Diameter	Inside Length	Inside Width	Weight (lbs/100')	Full drums		Vanguard Code
						feet	lbs	
9/32	4,300	0.275	0.880	0.410	72	800	576	3815 0018
3/8	8,800	0.397	1.220	0.570	150	400	600	3815 0024
1/2	15,000	0.520	1.560	0.750	261	200	522	3815 0032
5/8	22,600	0.630	1.930	0.920	361	150	542	3815 0040

GRADE 80 CHAINS

Grade 80 Chain Working Load Limits



Chain Size	Single 90°	Double 60°	Double 45°	Double 30°	Triple/Quad 60°	Triple/Quad 45°	Triple/Quad 30°
9/32	3,500	6,100	4,900	3,500	9,100	7,400	5,200
3/8	7,100	12,300	10,000	7,100	18,400	15,100	10,600
1/2	12,000	20,800	17,000	12,000	31,200	25,500	18,000
5/8	18,100	31,300	25,600	18,100	47,000	38,400	27,100
3/4	28,300	49,000	40,000	28,300	73,500	60,000	42,400
7/8	34,200	59,200	48,400	34,200	88,900	72,500	51,300
1	47,700	82,600	67,400	47,700	123,800	101,000	71,500

Grade 80 Component Selection Guide

Sling Type	Chain Size	Oblong Master Link	Master Link SA	Coupling Link	Clevis Grab Hook	Clevis Sling Hook	Eye Grab Hook	Eye Sling Hook
Single	9/32	1/2		9/32	9/32	9/32	9/32	9/32
Double		1/2						
Triple/Quad			3/4					
Single	3/8	3/4		3/8	3/8	3/8	3/8	3/8
Double		3/4						
Triple/Quad			1					
Single	1/2	1		1/2	1/2	1/2	1/2	1/2
Double		1						
Triple/Quad			1 1/4					
Single	5/8	1		5/8	5/8	5/8	5/8	5/8
Double		1 1/4						
Triple/Quad			1 1/2					
Single	3/4	1 1/4		3/4	3/4	3/4	3/4	3/4
Double		1 1/2						
Triple/Quad			1 3/4					
Single	7/8	1 1/2		7/8	7/8		7/8	7/8
Double		1 3/4						
Triple/Quad			2					
Single	1	1 3/4		1			1	1
Double		2						
Triple/Quad			2 1/4					

Warning:

**NEVER EXCEED WORKING LOAD LIMITS!
USE ONLY GRADE 80 CHAINS OR HIGHER FOR OVERHEAD LIFTING APPLICATIONS!
ALWAYS INSPECT CHAINS & FITTINGS PRIOR TO USE!**

Alloy Lifting Chain Grade 80

Grade 80 alloy chain is used for overhead lifting.

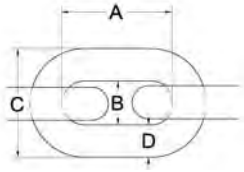

Code	Diameter in.	Working Load Limit lbs.	Weight / 100 ft lbs.	Dimensions in.			
				A	B Min	C Max	D
CH80SC-732	7/32	2,100	47.0	.680	.319	.787	.217
CH80SC-932	9/32	3,500	73.8	.826	.375	.992	.276
CH80SC-516	5/16	4,500	93.9	.945	.430	1.134	.315
CH80SC-038	3/8	7,100	147.5	1.181	.531	1.417	.394
CH80SC-012	1/2	12,000	254.8	1.535	.689	1.843	.512
CH80SC-058	5/8	18,100	383.0	1.890	.846	2.268	.630
CH80SC-034	3/4	28,300	578.0	2.440	1.008	2.776	.787
CH80SC-078	7/8	34,200	732.4	2.598	1.161	3.118	.866
CH80SC-001	1	47,700	1,021.4	3.071	1.378	3.685	1.024
CH80SC-114	1 1/4	72,300	1,545.5	3.780	1.701	4.528	1.260

Safety Factor 4:1

Grade 100 Chains, Slings and Components also available.

Hammerlock Type Connecting Links (alloy Gr 80)

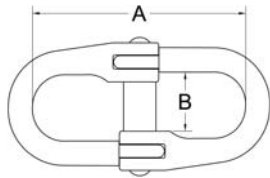

Code	For chain diameter in.	Working Load Limit lbs.	Weight / ea. lbs.	Dimensions in.	
				A	B
A337-932	9/32	3,500	0.23	1.87	0.60
A337-038	3/8	7,100	0.65	2.69	0.81
A337-012	1/2	12,000	1.50	3.44	1.09
A337-058	5/8	18,100	2.60	4.17	1.35
A337-034	3/4	28,300	3.80	5.06	1.50
A337-078	7/8	34,200	6.30	5.82	2.12
A337-001	1	47,700	9.30	6.48	2.55
A337-114	1 1/4	72,300	17.3	8.48	3.52

Safety Factor 4:1

Eye Cradle Grab Hooks (alloy Gr 80)

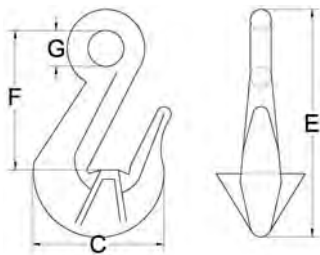

Code	For Chain Size in.	Working Load Limit lbs.	Weight / ea. lbs.	Dimensions in.			
				C	E	F	G
EGH80-732	7/32	2,100	.35	1.75	2.69	1.63	.63
EGH80-932	9/32	3,500	.40	1.81	3.44	2.36	.63
EGH80-038	3/8	7,100	1.06	2.63	4.67	3.11	.78
EGH80-012	1/2	12,000	2.26	3.34	5.86	3.94	1.03
EGH80-058	5/8	18,100	4.36	4.08	7.13	4.78	1.25
EGH80-034	3/4	28,300	8.82	5.23	8.99	6.25	1.44
EGH80-078	7/8	34,200	10.40	5.69	9.63	6.50	1.75
EGH80-001	1	47,700	20.90	7.00	12.44	8.09	1.88
EGH80-114	1 1/4	72,300	40.00	8.50	15.56	10.50	2.25

Safety Factor 4:1



EYE BOLTS

Shoulder Nut Eye Bolts

- Forged Carbon Steel, quenched & tempered, hot dip galvanized with heavy hex nut

Size (A x B)		Dimensions (inches)			WLL (lbs)	Weight (lbs)	Vanguard Code
Diameter (A)	Shank (B)	C	D	E			
1/4	2	1.61	0.47	0.90	650	0.06	2971 1020
1/4	4	2.40	0.47	0.90	650	0.08	2971 1040
5/16	2 1/4	1.50	0.62	1.15	1,200	0.11	2971 2022
5/16	4 1/4	2.35	0.57	1.15	1,200	0.16	2971 2042
3/8	2 1/2	1.52	0.73	1.40	1,550	0.17	2971 3025
3/8	4 1/2	2.61	0.73	1.40	1,550	0.25	2971 3045
1/2	3 1/4	1.53	1.00	1.83	2,600	0.40	2971 4032
1/2	6	3.00	1.00	1.83	2,600	0.53	2971 4060
5/8	4	2.12	1.23	2.27	5,200	0.78	2971 5040
5/8	6	3.13	1.23	2.27	5,200	0.81	2971 5060
3/4	4 1/2	2.13	1.45	2.70	7,200	1.41	2971 6045
3/4	6	3.11	1.45	2.70	7,200	1.51	2971 6060
1	6	3.08	1.95	3.70	13,300	3.20	2971 7060

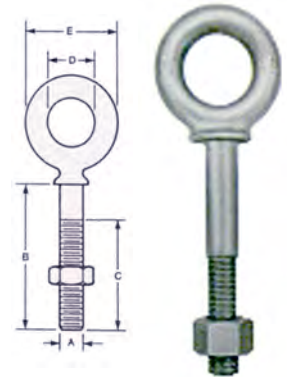

Regular Nut Eye Bolts

Size (A x B)		Dimensions (inches)			WLL (lbs)	Weight (lbs)	Vanguard Code
Diameter (A)	Shank (B)	C	D	E			
5/16	4 1/4	2.48	0.60	1.25	1,200	0.16	2970 2042
3/8	2 1/2	1.51	0.75	1.49	1,550	0.19	2970 3025
3/8	4 1/2	2.45	0.75	1.49	1,550	0.25	2970 3045
3/8	6	2.55	0.75	1.49	1,550	0.30	2970 3060
1/2	3 1/4	1.48	1.00	2.04	2,600	0.51	2970 4032
1/2	6	3.15	1.00	2.04	2,600	0.63	2970 4060
1/2	8	3.06	1.00	2.04	2,600	0.76	2970 4080
1/2	10	3.05	1.00	2.04	2,600	0.87	2970 4100
1/2	12	3.20	1.00	2.04	2,600	1.00	2970 4120
5/8	4	2.08	1.23	2.49	5,200	0.94	2970 5040
5/8	6	3.25	1.23	2.49	5,200	1.13	2970 5060
5/8	8	3.07	1.23	2.49	5,200	1.32	2970 5080
5/8	10	3.10	1.23	2.49	5,200	1.49	2970 5100
5/8	12	4.11	1.23	2.49	5,200	1.59	2970 5120
3/4	4 1/2	2.25	1.44	2.95	7,200	1.51	2970 6045
3/4	6	3.04	1.44	2.95	7,200	1.82	2970 6060
3/4	8	3.14	1.44	2.95	7,200	1.95	2970 6080
3/4	10	3.17	1.44	2.95	7,200	2.08	2970 6100
3/4	12	4.22	1.44	2.95	7,200	2.77	2970 6120
1	6	3.00	1.95	3.99	13,300	3.23	2970 7060
1	12	3.90	1.95	3.99	13,300	4.68	2970 7120

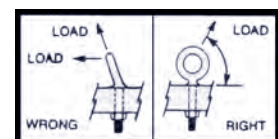
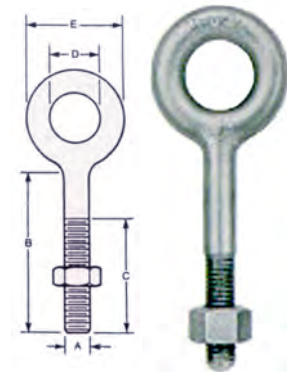

Warning:

NEVER EXCEED WORKING LOAD LIMITS!
WORKING LOAD LIMITS PERTAIN TO IN-LINE PULLS ONLY!
DO NOT USE EYE BOLTS WHICH SHOW SIGNS OF WEAR OR DEFORMATION!
ANGULAR LIFTS: Do not use Regular Nut Eye Bolts - use only Shoulder Nut or Machinery Eye Bolts and observe the following reduced Working Load Limits:

Lift Angle	Max. Load
45°	30% of WLL
90°	25% of WLL

CHAIN HOOKS

'Black Pin'® Clevis Slip Hooks - Alloy Steel

- For use with Grade 70 or lower grade chains only
- Gold Chromated body with 'black pin'
- Available with or without latches

Size	WLL (lbs)	Dimensions (inches)				Weight (lbs)	Vanguard Code (1) Include Latch
		A	B	C	D		
1/4	2,750	0.43	0.38	0.98	2.52	0.65	3903 1016 (1)
5/16	4,300	0.51	0.43	1.10	2.82	0.92	3903 1020 (1)
3/8	5,250	0.58	0.47	1.33	3.22	1.32	3903 1024 (1)
7/16	7,000	0.67	0.54	1.61	3.69	2.07	3903 1028 (1)
1/2	9,000	0.76	0.62	1.74	3.99	2.90	3903 1032 (1)

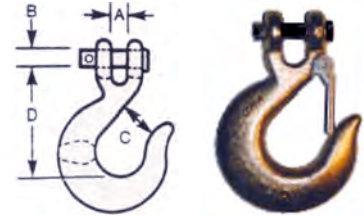

Eye Grab Hooks - Carbon Steel

- For use with Grade 40 or lower grade chains only

Size	WLL (lbs)	Dimensions (inches)			Weight (lbs)	Vanguard Code
		A	B	C		
1/4	2,600	0.53	1.92	0.34	0.30	3933 0016
5/16	3,900	0.61	2.29	0.43	0.51	3933 0020
3/8	5,400	0.80	2.65	0.49	0.88	3933 0024
1/2	9,200	0.89	3.21	0.65	1.79	3933 0032

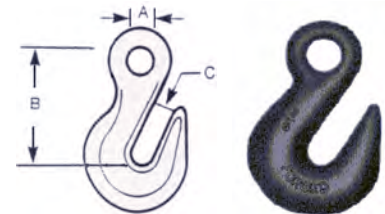

Eye Slip Hooks - Carbon Steel

- For use with Grade 40 or lower grade chains only
- Galvanized

Size	WLL (lbs)	Dimensions (inches)			Weight (lbs)	Vanguard Code
		A	B	C		
1/4	1,950	0.50	2.54	0.94	0.49	3908 0016
5/16	2,875	0.62	2.92	1.07	0.62	3908 0020
3/8	4,000	0.73	3.34	1.33	0.98	3908 0024
1/2	6,500	0.94	4.04	1.66	2.52	3908 0032



Warning:

NEVER EXCEED WORKING LOAD LIMITS!
DO NOT USE GRADE 40 or 70 CHAINS FOR OVERHEAD LIFTING APPLICATIONS!
 Inspect hooks and latches frequently - Measure opening (C) and compare with dimensions shown.
 Increased opening indicates overloading!
 Discard hooks which show signs of deformation or excessive wear!

CHAIN HOOKS

'Gold Pin'® Clevis Grab Hooks - Carbon Steel

- For use with Grade 40 or lower grade chains only
- Self-coloured body with 'gold pin'

Size	WLL (lbs)	Dimensions (inches)				Weight (lbs)	Vanguard Code*
		A	B	C	D		
1/4	2,600	0.35	0.38	0.39	1.97	0.45	3930 0016
5/16	3,900	0.41	0.43	0.44	2.27	0.74	3930 0020
3/8	5,400	0.47	0.47	0.51	2.63	1.14	3930 0024
7/16	7,200	0.67	0.55	0.58	2.79	1.45	3930 0028
1/2	9,200	0.73	0.62	0.69	3.13	2.30	3930 0032

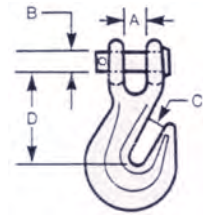

* For Galvanized Clevis Grab Hooks replace the 5th character of the product code with a "5" (example: 3930 5016 for 1/4" Galvanized)

'Black Pin'® Clevis Grab Hooks - Alloy Steel

- For use with Grade 70 or lower grade chains only
- Gold Chromated body with 'black pin'

Size	WLL (lbs)	Dimensions (inches)				Weight (lbs)	Vanguard Code
		A	B	C	D		
1/4	3,150	0.36	0.38	0.39	1.97	0.46	3931 0016
5/16	4,700	0.38	0.44	0.43	2.28	0.75	3931 0020
3/8	6,600	0.47	0.47	0.50	2.61	1.10	3931 0024
7/16	8,800	0.67	0.55	0.58	2.79	1.53	3931 0028
1/2	11,300	0.76	0.62	0.67	3.13	2.34	3931 0032

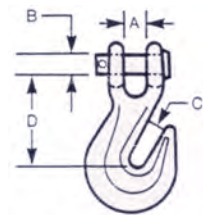

'Gold Pin'® Clevis Slip Hooks - Carbon Steel

- For use with Grade 40 or lower grade chains only
- Self-coloured or galvanized (1) body with 'gold pin'

Size	WLL (lbs)	Dimensions (inches)				Weight (lbs)	Vanguard Code
		A	B	C	D		
1/4	1,950	0.43	0.37	0.98	2.61	0.65	3903 0016 (1)
5/16	2,875	0.50	0.43	1.08	2.81	0.91	3903 0020 (1)
3/8	4,000	0.58	0.48	1.37	3.24	1.30	3903 0024 (1)
7/16	5,000	0.67	0.55	1.59	3.70	2.18	3903 0028 (1)
1/2	6,500	0.75	0.64	1.73	3.95	3.00	3903 0032 (1)

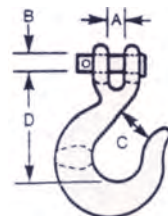

Note:

Forged Carbon or Alloy Steel, heat treated
Design Factor 4:1
Refer to specific applications and warnings!

LOAD BINDERS

Load Tighteners

- For 3/16" chain - light duty applications only
- WLL 250 lbs
- Approximate weight - 1.5 lbs/ea
- Vanguard Code: 3904 0012



Lever Type Load Binders

- Forged steel - quenched & tempered
- Ball & Socket swivel joints at hook assembly permit a straight line pull

Chain Size	Dimensions (inches)								WLL (lbs)	NBS (lbs)	Weight (lbs)	Vanguard Code
	A	B	C	D	E	F	G	Take up				
1/4	20.00	17.90	13.70	11.60	8.00	8.00	0.36	3.62	2,600	7,800	2.4	3904 0016
5/16 - 3/8	24.10	22.10	17.90	16.00	10.40	10.40	0.05	4.25	5,400	19,000	7.0	3904 0024
3/8 - 1/2	27.00	25.50	22.00	18.50	12.50	12.50	0.60	4.25	9,200	33,000	10.5	3904 0032

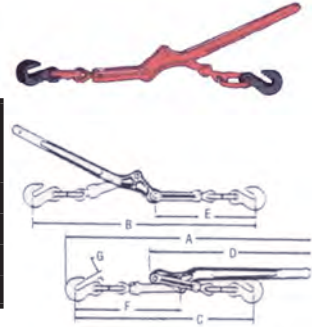

Recoilless Load Binders

- Forged load bearing parts - quenched & tempered

Chain Size	Dimensions (inches)							WLL (lbs)	Breaking Strength (lbs)	Weight (lbs)	Vanguard Code
	A	B	C	D	E	F	Take up				
5/16 - 3/8	24.10	23.70	19.70	13.20	11.00	11.00	4.50	5,400	19,000	9.20	3906 0024



Ratchet Type Load Binders

- Forged load bearing parts - Continuous take-up

Chain Size	Dimensions							WLL (lbs)	Breaking Strength (lbs)	Weight (lbs)	Vanguard Code
	A	B	C	D	E	F	Take up				
1/4	6.80	0.88	1.57	16.00	17.80	0.32	5.00	2,600	7,800	4.00	3905 0016
5/16 - 3/8	14.00	1.38	2.75	23.00	25.30	0.50	8.00	5,400	19,000	10.50	3905 0024
3/8 - 1/2	14.00	1.38	2.75	25.20	28.50	0.60	8.00	9,200	33,000	13.00	3905 0032
1/2 - 5/8	14.30	1.40	2.50	26.00	29.00	0.70	9.00	13,000	46,000	15.00	3905 0040

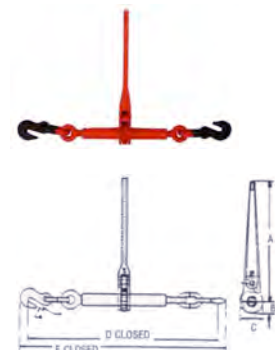

Tarp Tie-down Straps

- Branded straps available either in 100% natural rubber (black) or synthetic EPDM (artic-blue)
- With UV and Ozone inhibitor for better resistance against cracking
- For conditions with extreme atmospheric Ozone levels (high pollution in temperatures between -2° and +3° C we recommend EPDM straps with increased resistance against corrosion)
- Elastic stretch to 150% of nominal length

Type	Dimensions (inches)		Vanguard Code
	Length	Max. Stretch	
100% Natural Rubber (Black)	4	6	3708 0004
100% Natural Rubber (Black)	9	14	3708 0009
100% Natural Rubber (Black)	15	23	3708 0015
100% Natural Rubber (Black)	21	32	3708 0021
100% Natural Rubber (Black)	31	47	3708 0031
100% Natural Rubber (Black)	41	62	3708 0041
Artic Blue EPDM	9	14	3708 1009
Artic Blue EPDM	15	23	3708 1015
Artic Blue EPDM	21	32	3708 1021
Artic Blue EPDM	31	47	3708 1031



Hand Swagers, 1 cavity, USA

Length : 20"— Weight : 4.2 lbs

Code	For Oval Sleeves	For Stop Sleeves	For Oval Sleeves Stainless Steel
HS-0A	3/64	3/64	1/16
HS-0B	1/16	1/16	3/32
HS-0C	3/32	3/32 – 1/8	1/8
HS-0D	1/8	3/32 – 3/16 – 7/32	—
HS-0E	5/32	—	—
HS-0F	3/16	—	—



Length : 28"— Weight : 5 lbs

Code	For Oval Sleeves	For Stop Sleeves
HS-1A	7/32	—
HS-1B	1/4	1/4 – 9/32 – 5/16
HS-1C	9/32	—
HS-1D	5/16	—
HS-1E	3/8	—



Length : 8"— Weight : 8oz

Code	For Oval Sleeves	For Stop Sleeves
S 132	1/32	1/32
S 1532	3/64	3/64
S 232	1/16	1/16



Functional Swagers, USA - Japan

Length : 14"— Weight : 2 lbs.

Code	For Oval Sleeves	For Stop Sleeves	Made in
HS-2	3/64 – 1/16 – 3/32	3/64 – 1/16 – 3/32 – 1/8	USA
HS-2A	1/16 – 3/32	1/16 – 3/32 – 1/8	Japan



Pocket Hand Swagers, USA

Length : 9"— Weight : 12 oz.

Code	For Oval Sleeves	For Stop Sleeves
HS-3	1/32 – 3/64 – 1/16	1/32 – 3/64 – 1/16



S2632H

Multicompression Hand Swagers with Cable Cutter, USA - Japan

Length : 28"— Weight : 6.5 lbs.

Code	For Oval Sleeves	For Stop Sleeves	Made in
S2632H	1/16 – 3/32 – 1/8 – 5/32 – 3/16	1/16 – 3/32 – 1/8 – 5/32 – 3/16 – 7/32	USA
HS-5	1/16 – 3/32 – 1/8 – 5/32 – 3/16	1/16 – 3/32 – 1/8 – 5/32 – 3/16 – 7/32	Japan



HS5



S2632B

Bench Swagers, USA - Japan

Length 22.5" , Height 6.25" (height with handle up 24"),
Weight 6.6 lbs.

Code	For Oval Sleeves	For Stop Sleeves	Made in
S2632B	1/16 – 3/32 – 1/8 – 5/32 – 3/16	1/16 – 3/32 – 1/8 – 5/32 – 3/16 – 7/32	USA
BS-1	1/16 – 3/32 – 1/8 – 5/32 – 3/16	1/16 – 3/32 – 1/8 – 5/32 – 3/16 – 7/32	Japan



BS-1



“Felco” Wire Rope Cutters, Switzerland

Code	For Cable Diameter in.	Length in.	Weight ea. lbs.
FC-7	0 – 3/16	8	0.625
FC-9	0 – 1/4	13	1.500
FC-12	0 – 3/8	19	3.000
FC-16	0 – 5/8	23	5.000



FC-7



FC-16



FC-12



FC-9

Wire Rope Cutters, Japan

Code	For Cable Diameter in.	Length in.	Weight ea. lbs.
RC-8	Up to 3/16	8	0.66
RC-450	Up to 1/2	19	3.00
RC-800	Up to 5/8	23	5.00



RC-800



RC-8



RC-450

Wire Rope Cutters, USA

Code	For Cable Diameter in.	Length in.	Weight ea. oz.
C632	Up to 3/16	8"	5.5



Hammer Cable Cutters

Code	Description	For Cable Diameter in.
SFCC-1	IMPACTO #1	Up to 3/4



Spare Parts

Code	Description	For Cable Diameter in.
SFPIS-12	Plunger #1	0 – 3/4
SFTB-12	Top blade #1 & 2	0 – 3/4
SFBB-1	Bottom blade #1	0 – 3/4
SFBB-2	Bottom blade #1	0 – 1 1/16



Impact Wire Rope Cutters

- Portable cutters strictly designed for cutting wire ropes.
- Just a few hammer blows will result in a clean cut without affecting the roundness of the rope.
- Replacement parts are available for all models

Model No.	Rope Diameter (maximum)	Height	Base	Weight (lbs)	Vanguard Code
1	3/4	6	3 1/2	8	3001 5000
1A	1 1/16	7	6 1/4	17	3001 5001
2	1 1/2	9	7 3/4	28	3001 6000



Chain Pliers

Model No.	Length (inches)	Weight (lbs)	Vanguard Code
7302	20 3/4	5	4004 0020
7302	30	7	4004 0030



Cable Cutters



THE ORIGINAL CUTTERS FROM SWITZERLAND

- The tools for 'professionals' cutting wire rope, steel rod or wire.
- Strong, lightweight aluminum handles and special alloy steel blades for outstanding performance
- Cutting capacity optimized by the shape of the handles
- Special rust protection for all parts of the cutters







Model No.	Application	Maximum Diameter	Overall Length	Weight (lbs)	Vanguard Code
C-7	Mild Steel Strand	1/4	8	0.63	3001 0007
	High Tensile Steel Strand	3/16			
	Hard Drawn Spring Wire	3/32			
	Mild Steel & Barbed Wire	3/16			
C-9	Wire Ropes & Strands	3/16	13	1.63	3001 0009
	Mild Steel Strands	11/32			
	High Tensile Steel Strands, Steel Rods	1/4			
C-12	Wire Ropes & Strands	3/8	19	3.00	3001 0012
	Steel Rods	5/16			
	Tempered Spring Wire	5/32			
C-16*	Wire Ropes & Strands	5/8	23	5.00	3001 0016
	Steel Rods	7/16			
	Tempered Spring Wire	3/16			
C-108*	High Tensile Steel Strands, Steel Rods	5/16	22	4.50	3001 0108
	Tempered Spring Wire	1/4			
C-112*	High Tensile Steel Strands, Steel Rods	1/2	28	8.00	3001 0112
	Tempered Spring Wire	5/16			



- **C-16 Cutters** are also available for Electrical Cables (C-16E)
- **C-108 & C-112 Cutters** are featuring Felco's unique Reduction Gearing System, which provides



9000 Series Web Slings

	Web Width	Code Number	RATED CAPACITIES IN LBS.		
			Vertical	Choker	Basket
TYPE 1 SLINGS Choker & Basket Hitch Triangle & Choker Fittings 	SINGLE PLY				
	2"	TC1-902	3,200	2,400	6,400
	3"	TC1-903	4,800	3,600	9,600
	4"	TC1-904	6,400	4,800	12,800
	5"	TC1-905	8,000	6,000	16,000
	6"	TC1-906	9,600	7,200	19,200
	8"	TC1-908	12,800	9,600	25,600
	10"	TC1-910	16,000	12,000	32,000
	12"	TC1-912	19,200	14,400	38,400
	TWO PLY				
	2"	TC2-902	5,600	4,200	11,200
	3"	TC2-903	8,400	6,300	16,800
	5"	TC2-904	11,200	8,400	22,400
	5"	TC2-905	14,000	10,500	28,000
6"	TC2-906	16,800	12,600	33,600	
TYPE 2 SLINGS Basket and Vertical Hitches Only Two Triangle Fittings 	SINGLE PLY				
	2"	TT1-902	3,200		6,400
	3"	TT1-903	4,800		9,600
	4"	TT1-904	6,400		12,800
	5"	TT1-905	8,000		16,000
	6"	TT1-906	9,600		19,200
	8"	TT1-908	12,800		25,600
	10"	TT1-910	16,000		32,000
	12"	TT1-912	19,200		38,400
	TWO PLY				
	2"	TT2-902	5,600		11,200
	3"	TT2-903	8,400		16,800
	4"	TT2-904	11,200		22,400
	5"	TT2-905	14,000		28,000
6"	TT2-906	16,800		33,600	
TYPES 3 & 4 SLINGS Flat or Twisted Eyes Vertical, Choker, Basket Hitches 	SINGLE PLY				
	1"	EE1-901	1,600	1,200	3,200
	2"	EE1-902	3,200	2,400	6,400
	3"	EE1-903	4,800	3,600	9,600
	4"	EE1-904	6,400	4,800	12,800
	5"	EE1-905	8,000	6,000	16,000
	6"	EE1-906	9,600	7,200	19,200
	TWO PLY				
	1"	EE2-901	3,200	2,400	6,400
	2"	EE2-902	6,400	4,800	12,800
	3"	EE2-903	8,600	6,500	17,200
	4"	EE2-904	11,500	8,600	23,000
	5"	EE2-905	13,600	10,200	27,200
	6"	EE2-906	16,300	12,200	32,600
TYPE 5 SLINGS Vertical, Choker, Basket Hitches Endless or Grommet Type 	SINGLE PLY				
	1"	EN1-901	3,200	2,500	6,400
	2"	EN1-902	6,400	5,000	12,800
	3"	EN1-903	8,600	6,900	17,200
	4"	EN1-904	11,500	9,200	23,000
	5"	EN1-905	13,600	10,900	27,200
	6"	EN1-906	16,300	13,000	32,600
	TWO PLY				
	1"	EN2-901	6,100	4,900	12,200
	2"	EN2-902	12,200	9,800	24,400
	3"	EN2-903	16,300	13,000	32,600
	4"	EN2-904	20,700	16,500	41,400
	5"	EN2-905	24,500	19,600	49,000
	6"	EN2-906	28,600	23,000	57,200

INSPECTIONS —

Each day before being used, the sling and all fastenings and attachments shall be inspected for damage or defects by a competent person designated by the employer. Additional inspections shall be performed during sling use where service conditions warrant. Damaged or defective slings shall be immediately removed from service.

CAUTIONS:

- When preparing the load, protect against:
- Twists and kinks in the sling
 - Damage to sling from sharp edges and corners
 - Trapping sling between or under loads
 - Damage due to load turning in basket hitch
 - Overloading sling and excessive sling leg angles
 - Loading sling out of plane/side loading
 - Wear by use of wear pads or other protection
 - Exposure to fumes, vapours, sprays or mists of alkalis, aldehydes, ethers or concentrated sulphuric acids
 - Exposure to temperatures in excess of 200 °F.
 - General abuse

CARE & MAINTENANCE:

- When placing the sling into storage; the following should be considered:
- Examine for damage
 - Remove dirt and other foreign materials
 - Hang in clean dry area and avoid entanglement
 - Store away from exposure to sunlight
 - All accessories used with the sling must be free of sharp edges
 - If the red core warning yarns are noted the sling should be discarded
 - Slings must be removed from service if any of the following defects are noted:
 - Acid or caustic burns
 - Melting or charring of any sling part
 - Snags cuts and/or punctures
 - Distorted fittings

CAUTION DO NOT EXCEED RATED CAPACITIES

Working Load Limit: 3,335lbs (1,515kgs) B/S: 10,000(4,545kgs)



2" Ratchet Strap w/-18200 wire hook (7/16") and 70201 ratchet buckle

Working Load Limit: 3,335lbs (1,515kgs) B/S: 10,000(4,545kgs)



2" Ratchet Strap w/-18420 twisted snap hook and 70201 ratchet buckle

Working Load Limit: 3,335lbs (1,515kgs) B/S: 10,000(4,545kgs)



2" Ratchet Strap w/-18202 wire hook (3/8") and 70203 ratchet buckle

Working Load Limit: 1,666lbs (757kgs) B/S: 5,000(2,272kgs)



2" Ratchet Strap w/-38162 chain anchor and 70201 ratchet buckle

Working Load Limit: 3,335lbs (1,515kgs) B/S: 10,000(4,545kgs)

3" Ratchet Straps, webbing b/s: 18,000lbs



3" Ratchet Strap w/-18440 flat hook

Working Load Limit: 5,000lbs (2,272kgs) B/S: 15,000(6,818kgs)



RS21830-FXL	30FT
-------------	------

Part No.	Strap Length
RS21810-WXL	10FT
RS21812-WXL	12FT
RS21816-WXL	16FT
RS21820-WXL	20FT
RS21825-WXL	25FT
RS21830-WXL	30FT

Part No.	Strap Length
RS21810-TSL	10FT
RS21812-TSL	12FT
RS21816-TSL	16FT
RS21820-TSL	20FT
RS21825-TSL	25FT
RS21830-TSL	30FT

Part No.	Strap Length
RS21810-WS	10FT
RS21812-WS	12FT
RS21816-WS	16FT
RS21820-WS	20FT
RS21825-WS	25FT
RS21830-WS	30FT

Part No.	Strap Length
RS23310-C	10FT
RS23312-C	12FT
RS23316-C	16FT
RS23320-C	20FT
RS23325-C	25FT
RS23330-C	30FT

Part No.	Strap Length
RS31810-F	10FT
RS31812-F	12FT
RS31816-F	16FT
RS31820-F	20FT
RS31825-F	25FT
RS31830-F	30FT

Part No.	Strap Length
RS31810-W	10FT
RS31812-W	12FT
RS31816-W	16FT



70900 - Standard winch bar (chrome plated)



70901 - Combination winch bar (chrome plated)



70904 - Standard winch bar (black painted)



CARGO CONTROLS

3" Ratchet Strap w/-18201 wire hook (1/2")

Working Load Limit: 5,000lbs (2,272kgs) B/S: 15,000(6,818kgs)



3" Ratchet Strap w/-38150 grab hook

Working Load Limit: 5,400lbs (2,454kgs) B/S: 16,200(7,363kgs)



3" Ratchet Strap w/-18513 D ring

Working Load Limit: 6,000lbs (2,727kgs) B/S: 18,000(8,181kgs)



3" Ratchet Strap w/-38163 chain anchor

Working Load Limit: 6,000lbs (2,727kgs) B/S: 18,000(8,181kgs)

4" Ratchet Straps, webbing b/s: 24,000lbs



4" Ratchet Strap w/-18440 flat hook

Working Load Limit: 5,500lbs (2,500kgs) B/S: 16,500(7,500kgs)



4" Ratchet Strap w/-18100 wire hook

Working Load Limit: 6,600lbs (3,000kgs) B/S: 20,000lbs (9,090kgs)

RS31820-W	20FT
RS31825-W	25FT
RS31830-W	30FT

Part No.	Strap Length
RS31810-G	10FT
RS31812-G	12FT
RS31816-G	16FT
RS31820-G	20FT
RS31825-G	25FT
RS31830-G	30FT

Part No.	Strap Length
RS31810-D	10FT
RS31812-D	12FT
RS31816-D	16FT
RS31820-D	20FT
RS31825-D	25FT
RS31830-D	30FT

Part No.	Strap Length
RS33310-C	10FT
RS33312-C	12FT
RS33316-C	16FT
RS33320-C	20FT
RS33325-C	25FT
RS33330-C	30FT

Part No.	Strap Length
RS41810-F	10FT
RS41812-F	12FT
RS41816-F	16FT
RS41820-F	20FT
RS41825-F	25FT
RS41830-F	30FT

Part No.	Strap Length
RS41810-W	10FT
RS41812-W	12FT
RS41816-W	16FT
RS41820-W	20FT
RS41825-W	25FT
RS41830-W	30FT

Part No.	Strap Length
RS41810-D	10FT



91300 - Standard winch
Working Load Limit: 6,000lbs
B/S: 18,000lbs (8,181kgs)



91301 - Low Profile winch
Working Load Limit: 6,000lbs
B/S: 18,000lbs (8,181kgs)



91600 - Storable winch
Working Load Limit: 6,000lbs
B/S: 18,000lbs (8,181kgs)



91304 - Double L-Track
Working Load Limit: 5,000lbs
B/S: 15,000lbs (6,818kgs)

CORDAGES

3 strand nylon

Nylon rope has superior strength, abrasion and shock absorbing properties. It also has numerous uses in the industrial, commercial, and consumer markets.



6.4mm	396M	1/4"	1300'
7.9mm	297M	5/16"	975'
9.5mm	192M	3/8"	630'
12.7mm	102M	1/2"	335'
16.0mm	61M	5/8"	200'
19.0mm	91M	3/4"	300'
25.0mm	61M	1"	200'

Campbell waxed twine No. 6 and 12

Braided cord

Our braided nylon cord is a superior general purpose utility cord. It resists well to abrasion. Some of the most popular uses are for venetian blinds, awnings, and pulleys. They are also useful for starter cords and parasol cords.



6.4mm	183M	1/4"	600'
7.9mm	183M	5/16"	600'
9.5mm	183M	3/8"	600'
11.1mm	183M	7/16"	600'
12.7mm	183M	1/2"	600'
16.0mm	183M	5/8"	600'
19.0mm	183M	3/4"	600'
22.0mm	183M	7/8"	600'
25.0mm	183M	1"	600'

Braided sash cord

Cotton sash cord is a low stretch braided cord. It was previously well known for use in double hung windows, but has also proven to be an excellent clothesline and general-purpose cord.



3.2mm	305M	1/8"	1000'
4.0mm	152M	5/32"	500'
4.8mm	152M	3/16"	500'
6.4mm	76M	1/4"	250'
7.9mm	61M	5/16"	200'
9.5mm	38M	3/8"	125'
12.7mm	24M	1/2"	80'

3 strand polypropylene

Polypropylene is an economical choice as a general purpose rope. Available in hanks, reels or coils. It is widely used in industrial, construction, commercial, and household applications.

4.8mm	648M	3/16"	2125'
6.4mm	396M	1/4"	1300'
7.9mm	297M	5/16"	975'
9.5mm	192M	3/8"	630'
12.7mm	102M	1/2"	335'
16.0mm	61M	5/8"	200'
19.0mm	38M	3/4"	125'

Seine twine, mason and chalk line

Seine twine also known as cable cord, is a small diameter twisted twine. Constructed of 65% polyester and 35% cotton it makes an excellent general purpose twine.



200-18	white	#18	61M	200'
250-18	white	#18	168M	550'
275-18	white	#18	335M	1100'
300-18	pink	#18	61M	200'
350-18	pink	#18	168M	550'



Plastic twine



Sisal twine



Jute twine

ALSO BINDER TWINE

Strapping Systems



Polystrap Tensioner



Polystrap Sealer



Dispenser



Plastic Strapping Tools



Seals & Buckles for Polypropylene Strap

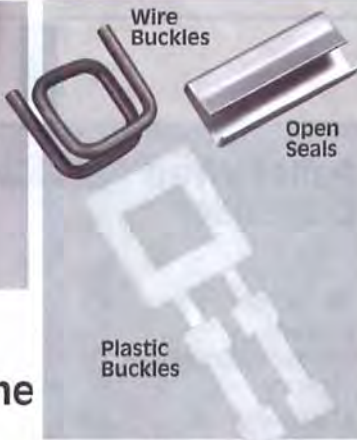

Polypropylene Strap

Size	Size	Strength
3/8" x 12,000'	8x8"	300 lbs.
1/2" x 9,000'	8x8"	300 lbs.
1/2" x 7,400'	8x8"	400 lbs.
3/8" x 12,900'	8x9"	300 lbs.
1/2" x 9,900'	8x9"	300 lbs.
1/2" x 8,500'	6x16"	300 lbs.
1/2" x 7,400'	6x16"	400 lbs.
1/2" x 6,600'	6x16"	500 lbs.
1/2" x 7,200'	6x16"	600 lbs.
1/2" x 5,000'	6x16"	750 lbs.
3/8" x 3,600'	6x16"	990 lbs.

Steel Strapping



Size
1/2" x 0.15
1/2" x 0.17
5/8" x 0.20
3/4" x 0.20

Seals

- Open type
- 2000 per case

Size
1/2" seals
3/8" seals
3/4" seals



Dispenser Cart

- Heavy Duty dispenser holds 3" (76mm) or 6" (152mm) face coils of strapping

- Features wheels for portability and a tray for storage of seals and tools

Description
Dispenser Cart
Standard Tensioner
HD Tensioner
LD Sealer (1/2")
1/2" HD Sealer
3/8" HD Sealer
3/4" HD Sealer
Steel Strap Cutter

Standard Duty Tensioner



Standard Duty Sealer

Steel Strapping Tools



Polyester Cord Strapping

- Replaces steel strap in many situations
- Easier and safer to use
- Use standard plastic strap tools with seals or buckles

Size	Strength
1/2" x 3900'	600 lbs.

Cord Strap Dispenser Cart

PACKAGING SUPPLIES

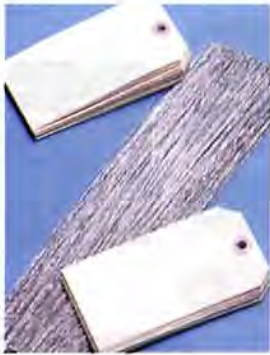

SHIPPING TAG WIRES

- Strong 305mm (12") wires let you attach shipping tags to merchandise
- 1000/bundle
- Item: ➔ 181380

KRAFT SHIPPING TAGS

- For items that do not hold labels easily
- Blank tags come unstrung with reinforced fastener hole
- Standard size: 67 x 133 mm (2 3/4" x 5 1/4")
- 1000/box
- Item: ➔ 181320



DOUBLE LOOP WIRE TIES 4" TO 16"



TWISTER TOOL



B PAINSTICK

The original all purpose cold surface marker -50 to 150 F



SHARPIE MARKER



Jiffy Artline400



Ball Markers



CORRUGATED CARDBOARD ROLLS

- Extremely effective for inner wrapping of fragile goods and for outer wrapping of odd-shaped items
- Often used as the first layer of wrapping before a layer of Kraft paper
- Single faced corrugated rolls are a light and flexible alternative to heavier and stiffer double-faced corrugated
- 250' per roll
- C flute



Ladder



Intermediate/Standard/Heavy-Duty/Extra Heavy-Duty



Super

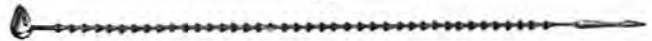

Secur-A-Tie®



Secur-A-Tach®

DENNISON BAR-LOK® CABLE TIES

- Used for fast, easy bundling of cable and wires
- Excellent for attaching safety ID's and tags to merchandise
- Normal operating temperatures from -40°C to 85°C (-40 to 185°F)
- Non-corrosive
- 100% nylon

Ladder Bar-Lok® Ties

- Tough, strong nylon polymeric chain; flexible and economical
- Standard/Intermediate/Heavy-Duty/Extra Heavy-Duty Bar-Lok® Ties**

- Bent tip for easy handling and installation; maximum holding ability

Super Bar-Lok® Ties

- Highest tensile strength

Secur-A-Tie® Fasteners

- Easy-to-use—wrap around bundle, insert pointed end into socket, pull tight
- Economical, resists rust and scratching

Secur-A-Tach® Fasteners

- Feature a double barreled locking head, perfect for tagging hard goods

Model	Type	Colour	Length	Dia. Max.	Min. Str.	Qty/Bag
F08470		Natural				
F08472	Ladder	Black	7"	1 1/4"	40 lb.	1000
F08471		Natural				
F08473	Ladder	Black	11"	3"	40 lb.	1000
F08387		Natural				
F08388	Standard	Black	7 1/2"	1 1/4"	50 lb.	1000
F08600		Natural				
F08286	Standard	Black	11"	3"	50 lb.	1000
F10036		Natural				
F10037	Standard	Black	15"	4"	50 lb.	500
F08376	Intermediate	Natural	5 1/2"	1 1/4"	40 lb.	1000
F08377		Natural				
F08380	Intermediate	Black	8"	2 1/4"	40 lb.	1000
F10038		Natural				
F10039	Heavy-Duty	Black	14 1/2"	4"	120 lb.	100
F10606		Natural				
F10608	Heavy-Duty	Black	21"	6"	120 lb.	50
F10612	Heavy-Duty	Natural	24"	7"	120 lb.	50
F10618		Natural				
F10620	Heavy-Duty	Black	28"	8"	120 lb.	50
F10049		Natural				
F10050	Extra H.D.	Black	33"	10"	175 lb.	25
F10001		Natural				
F10003	Super	Black	7 1/2"	1 1/4"	50 lb.	1000
F10344		Natural				
F10345	Super	Black	15"	4"	50 lb.	500
F08350	Secur-A-Tie	Natural	5"	1 1/4"	18 lb.	5000
F08302			3"			
F08300			5"			
F08301	Secur-A-Tach	Natural	9"	—	10-18 lb.	5000

Special Purpose Tapes



9mm + 72mm also available.
Call for pricing

SIZE: 12mm-18mm-24mm-36mm-48mm

Masking Tape

- All-purpose
- Available in three grades
- Dozens of industrial uses
- 55m roll length



Filament Tape

- Glass filament reinforced
- Super strong
- 55m roll length

SIZE: 9mm-12mm-18mm-24mm-36mm-48mm



We also have teflon tape

Electrical Tape

- CSA approved
- 19mmx20m
- 72 rolls per case

Duct Tape

- Easy-tear
- Reinforced cloth tape
- Standard colour is silver
- 55m roll length
- 24 rolls/case



Carton Sealing Tape

CLEAR OR TAN - 25 MICRON THICK



Tape Dispensers

Convenience Handwrap

- Ready-to-use
- Extended core ends act as handles
- Strong enough to secure heavy pallet loads
- 20"W x 1000'L per roll
- Sold 4 per case



KRYLON®

Quik-Mark Striping & Marking Equipment

47098 Can Holster

Specially designed for holding Marking Paint cans. Keeps paint conveniently accessible at all times. Constructed of rugged, leather-like vinyl with sturdy riveted seams. Measures 3 1/2" in diameter, 6 1/2" high.



47082 Parking Lot Stencil Kit

Striping Machines

Engineered and designed for easy operation, these durable Striping Machines let even first-time users create professional striping results on any ground surface.

- 18-gauge all-steel construction
- 12-can storage
- 4 sprayhead positions
- Stripes widths of 2" to 4"

47080 Pavement Striping Machine

Has 7" wheels that provide a smooth ride on hard surfaces such as concrete, blacktop and metal. Excellent for use in parking lots, warehouses, plants and factories, etc.

47081 Dual Striping Attachment

Applies two coats in one pass for double striping. Maintains constant width between stripes. Easily mounts to side of striping machine.



Marking Wands

Constructed of rugged plastic and lightweight steel, these durable tools offer a comfortable pistol grip for easy handling and marking. Both apply a uniform, 1" to 1-1/2" width of paint.

47096 Long Wand

Is hand-held, easy and comfortable to use from standing position; no back strain. Snap-out wheel is removable for easy writing of letters, numbers or stenciling 34" long.

47095 Short Wand

Is hand-held, ideal for quick and easy marking 12" long.

47097 Striping Wand

Perfect for easy stenciling or touch ups on striped surfaces. Durable plastic construction; 34" long with snap-out removable wheel.





AerVOE Survey Marking Paint



AerVOE Survey Marking Paint is a superior upside down marking paint that is designed for survey marking. It provides the best quality paint in terms of color visibility and retention, durability, and a lasting mark of up to six months. Non-freezing and operational to 14°F. Colors formulated to meet standards set by OSHA and APWA/One Call Systems.

FLUORESCENT COLOR SELECTION

220 Fl. Red	227 Fl. Blue
222 Fl. Orange	229 Fl. Pink
224 Fl. Green	230 Fl. Red-Orange
226 Fl. Yellow	288 Fl. H>D> Fl. Orange

Note: Survey Marking Paint contains a non-freezing formula; operational to 14°F (-10°C)

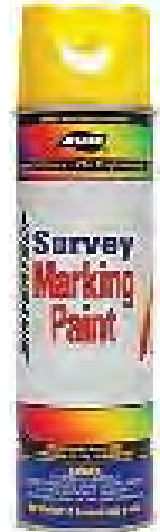

AerVOE Construction Marking Paint



AerVOE Construction Marking Paint is the flagship of the line, offering a high quality paint that is priced competitively to meet a variety of marking applications while providing good color visibility and durability. Why pay for the added quality of AerVOE Survey Marking Paint if the mark does not need to last as long? Great color durability up to three months.

FLUORESCENT COLOR SELECTION

246 Fl. Red	250 Fl. Blue
247 Fl. Orange	253 Fl. Yellow
248 Fl. Green	283 Fl. Red-Orange
249 Fl. Pink	

CAN SIZE (NET)	WEIGHT	CASE PACK
20-oz Aerosol(17-oz)	18 lbs.	12 cans



GALVANIZED / STEEL COATINGS

AerVOE galvanize coatings and stainless steel paints provide the ultimate in long term protection against rust and corrosion available today. They are acceptable as a coating in federally inspected meat and poultry plants for application to structural surfaces, or any surface where incidental food contact may occur. Crown galvanized coatings have been the industry benchmark for over 50 years... products that "sacrifice" the coating to chemically protect steel.

141 ZINC RICH GALVANIZE

- Contains 97% pure zinc metallic flake, which yields 94% zinc and 6% resin dry film
- Meets performance requirements of MIL-P-46105, and DOD-P-21035A
- Meets ASTM B-117-64 salt spray; withstands up to 2000 hours of salt spray exposure
- Performs at temperatures up to 400°F (204°C)
- Passed Preece test for hot-dip galvanizing
- Stops rust and corrosion on any steel or iron surface
- Outstanding weld through primer
- Zinc fuses to metal substrates for protection equal to or better than hot-dipped galvanizing
- Sacrificial anodization causes the zinc to sacrifice itself for the base metal's protection
- Not available in packages larger than gallon

Uses: Ideal for use on surfaces that are exposed to severe corrosive conditions, including structural steel, fencing, automobiles, guard rails, and bridges.

CAN SIZE (NET)	WEIGHT	CASE PACK
16-ounce Aerosol (13-oz.)	14 lbs.	12 Cans
Quart Can	32 lbs.	6 Quarts
Gallon Can	22 lbs.	1 Gallon

142 BRITE GALVANIZE

- 65% pure zinc in dry film
- Meets performance requirements of ASTM A780-93A
- Performs at temperatures up to 400°F (204°C)
- Restores galvanized surfaces to the bright look of hot-dip; shiny silver finish
- Stops rust and corrosion on any steel or iron surface
- Outstanding weld-through primer
- Can be used as primer or top coat
- Zinc fuses to metal substrates for protection equal to or better than hot-dipped galvanizing
- Sacrificial anodization causes the zinc to sacrifice itself for the base metal's protection
- Dries to touch in just 10 minutes
- Not available in packages larger than gallon

Uses: Pipes, heavy equipment, fencing, wrought iron, guard rails, hand rails, welds, metal, bridges, storage tanks, corrugated metal buildings, transformers, television towers, signs and sign posts, and where the bright look of hot-dipped surfaces are desired.

CAN SIZE (NET)	WEIGHT	CASE PACK
16-ounce Aerosol (13-oz.)	14 lbs.	12 Cans
Quart Can	27 lbs.	6 Quarts
Gallon Can	12 lbs.	1 Gallon





MAINTENANCE

ECONO BRISTLE



Product No.	UPC#	Size		Shelf pack
i010305	103508	½"	13mm	50
i010310	103010	1"	25mm	50
i010315	103515	1½"	37mm	50
i010320	103027	2"	50mm	50
i010325	103522	2½"	64mm	50
i010330	103034	3"	75mm	25
i010340	103041	4"	100mm	25

CHIP & OIL BRISTLE



Product No.	UPC#	Size		Shelf pack
030005	300051	½"	13mm	36
030010	300105	1"	25mm	36
030015	300150	1½"	37mm	36
030020	300204	2"	50mm	24
030030	300303	3"	75mm	24
030040	300402	4"	100mm	12

PREMIUM BRISTLE



Straight

Product No.	UPC#	Size		Shelf pack
015010	150106	1"	25mm	20
015020	150205	2"	50mm	20
015030	150304	3"	75mm	10

Angular

Product No.	UPC#	Size		Shelf pack
015710	157105	1"	25mm	20
015715	157150	1½"	37mm	20
015720	157204	2"	50mm	20



SPECIAL PURPOSE

Parts Cleaning



TAMPICO

Description	Product No.	UPC#	Size	Shelf pack
Tampico	012308	123087	#8	20
Tampico(Flat)	012310	123100	#10	10
Tampico	012330	123308	#30	20
(Dome) Crimped Nylon	022312	223121	#8	20
Nylon(Dome)	022311	223114	#10	10
Nylon	012340	123407	#40	10



White Wash

Product No.	UPC#	Size	Shelf pack
040001	400010	7" 190mm	10

Shingle

Product No.	UPC#	Size	Shelf pack
012420	124206	2" 50mm	20
012430	124305	3" 75mm	10
012440	124404	4" 100mm	10

OVAL BRUSHES



Product No.	UPC#	Size	Shelf pack
011902	119028	#2 (13/32" Diam)	20
011904	119042	#4 (21/32" Diam)	20
011906	119066	#6 (25/32" Diam)	20
011908	119080	#8 (15/16" Diam)	20
011910	119103	#10 (1 1/16" Diam)	10



Plastic

Product No.	UPC#	Size	Shelf pack
180027	800278	9½" 240mm	6
180024	800247	9½" 240mm	20
180004	800049	4" 100mm	20
180028	800285	3" 75mm	24

Metal



Metal Trays

Product No.	UPC#	Size	Shelf pack
180021	800216	4Lt. 9½" 240mm	10
180020	800209	2Lt. 9½" 240mm	10
180026	800261	1Lt. 9½" 240mm	20

Bucket Grid

Product No.	UPC#	Shelf pack
180019	800193	36/12

Solvent Resistant Tray Liners

Product No.	UPC#	Size	Shelf pack
180012	800124	1Lt. 9½" 240mm	24
180013	800131	2Lt. 9½" 240mm	24

Frames



5 Wire Frame

Product No.	UPC#	Size	Shelf pack
150395	503957	9½" 240mm	10

Handle 16"

Product No.	UPC#	Size	Shelf pack
154241	542413	4" 100mm	24

Handle 10"

Product No.	UPC#	Size	Shelf pack
154240	542406	4" 100mm	36

Refills



Solvent resistant core

Product No.	UPC #	Pile hight	Size	Self Pack
122195	221950	1/4"- 5MM	9½" 240mm	20
122295	222957	1/2"-13MM	9½" 240mm	20
122395	223954	3/4"-19MM	9½" 240mm	10
122495	224951	1"- 25MM	9½" 240mm	10



SPECIAL PURPOSE BRUSHES

Diam. mm	Size In / mm	Thickness mm	Length Out mm	Pack
-------------	-----------------	-----------------	------------------	------

2055 OVAL SASH

Pure bristle, hardwood, stained handle. Used for sash, mouldings and pipes. Used industrially for glue shellac and machine cleaning.

12	#2		35	20
22	#4		46	20
25	#6		48	10
29	#8		54	10



2065 FLAT RADIATOR

Pure bristle, long handle. Designed for radiators and hard-to-reach surfaces.

30		8	58	10
----	--	---	----	----



2075/85 BENT RADIATOR

Pure bristle long handle offset 45 degrees for painting radiators pipes or machinery. #2085 is ideal for use in the ship building industry.

30		8	58	10
50		16	59	10



2264 CLEANING TOOL

Heavy gauge nylon filaments, hardwood clear-lacquered handle. For cleaning or greasing machinery.

31	#2		83	10
----	----	--	----	----

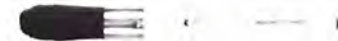

2430 WATERPROOFING BRUSH

100% Polyester filaments. Ideal for applying all waterproofing products.

100		19	76	10
-----	--	----	----	----



2440 STAIN BRUSH

Made with grey bristle ideal for stain applications, also for use with oil paints.

75	13	65	20
100	16	71	20



2460 THRIFTY WHITEWASH

White fibre. For applying cement paints, foundation coatings or driveway sealers.

165	20	67	20
-----	----	----	----



2475/76/77 FOAM

Economy priced foam brushes with wooden handles. Throw-away type, good for touch-up jobs and ideal for applying urethane.

	(1")25	12	50	48
	(2")50	14	60	48
	(3")75	14	60	36
	(4")100	18	70	24
#2476	(2")50	14	65	50
#2477	(1"-2"-3")		24	



2476



2477



FOR OIL PAINTS

Size mm	Length Out mm	Thickness mm	Pack
---------	---------------	--------------	------

603 RESIN

Pure white bristle, with metal ferrules and plain wood handles. Many industrial uses where a wooden handle is preferred.

(1") 25	38	8	36
(2") 50	38	8	24
(3") 75	38	10	12
(4") 100	44	10	12



310 "GO" BULK

Lowest priced line of bristle brushes with red handles. Well suited for fibreglass applications, epoxy resins, paint remover and many other industrial uses.

30	48	8	50
50	48	10	50
75	50	13	25
100	50	13	25



320 ★★ "ECONOMY"

A popular line of bristle paint brushes with silver handles. Packages in poly bags with printed labels.

15	42	7	20
30	52	10	20
50	52	12	10
75	65	13	10
100	65	16	10



420 ★★★ "SUPERB"

Medium priced bristle brush. Gold handles with black band and red tip. Packaged in self-vinyl keepers.

30	59	13	10
50	65	16	10
75	71	19	10
100	78	19	10



520 ★★★★ "FRE-FLO"

Our top-of-the-line brush. Black handles with gold band and red tip. Packaged in an ease-of-purchase self-vinyl keeper.

30	65	13	10
50	71	16	10
75	78	19	10
100	84	19	10



Rubberset's bristle brushes are made with the finest quality processed Chinese hog bristles that keep their shape. Bristles are set with epoxy resins in non corroding tin plate ferrules.



Cat. No.	Description	Size mm	Dia. mm	Pack
----------	-------------	---------	---------	------

ROLLER FRAMES

5470 - Cage Type (4 Wire)	190	38	10
5490 - Cage Type (5 Wire)	240	38	10

The wire cage style construction of these frames allows fast and easy changes of sleeves preferred by the Do-It-Yourself Consumer. The ¼" dia. steel shanks rod is light, sturdy and well balanced for uniform pressure. A strong polypropylene handle is specially shaped to position roller correctly and comfortable in hand, making use less tiring, handles are threaded to accept all types of extension poles.

8199 - Cage Type (5 Wire)	240	38	10
----------------------------------	-----	----	----

These cage frames are similar to the ones described above. However they are of "Heavy Duty" construction for the PROFESSIONAL. The five wire cage is on a tough ½" dia. shank rod, and has all the other features of the consumer cage.

8295 - Super Pro Cage (5 Wire)	240	38	10
---------------------------------------	-----	----	----

5623 - Top Line Pro Cage (5 Wire) Hardwood Handle	240	38	6
---	-----	----	---



ROLLER TRAYS (Consumer)

6174 - Metal Tray For 190 mm Rollers.	20
6184 - Plastic Tray For 240 mm Rollers.	10
6194 - Metal Tray For 240 mm Rollers.	20

These deep well, rust-resistant metal trays and plastic trays have ladder grip type legs. For use by the Do-It-Yourself consumer.



ROLLER TRAYS (Professional)

8474 - Metal Tray For 240 mm Rollers Approximately 2 litre capacity	10
---	----

8484 - Metal Tray For 240 mm Rollers Approximately 4 litre capacity	10
---	----

These trays are of Heavy Duty Rust-Resistant metal, deeper well than the 6194's. Has sturdy metal legs for use with ladders.

8493 - Pro Tray Plastic For 400 mm Roller Holds about 18 litres.	1
--	---

8494 - Pro Tray For 400 mm Roller Holds about 18 litres. Will accommodate up to 450 mm rollers. Galvanized metal tray size about 50 x 48 x 25 cm.	1
--	---

These trays are ideal for Professional and Contract Painters.



HVLP TURBINE SYSTEMS



1) T-55. An excellent unit for occasional work or as a starter kit. Its quiet 2 stage turbine provides dry warm air to the all metal 710 gun. This economically priced system uses the more expensive type air filter normally found on large commercial turbines. Sprays all conventional coatings including lacquer, enamel, latex, stain, and other light materials.

Specifications:

Amps @ 115 V	8
CFM - unrestricted	97
PSI - sealed	3.9
Turbine stages	2
Turbine diameter	5.7
T-55 Turbine system	L080-040

2) T-95. An excellent unit for heavy duty work. The industrial high volume air intake filter supplies clean air to the powerful yet quiet large diameter 3-stage turbine. It supplies warm dry air to the all metal 710 gun. Sprays all conventional coatings including lacquer, enamel, latex, stain, multi colour, and other materials.

Specifications:

Amps @ 115 V	10
CFM - unrestricted	110
PSI - sealed	7
Turbine stages	3
Turbine diameter	7.2
T-95 Turbine system	L080-045

The quickest and most economical way to paint parking lot lines. Spray one 20' line in approximately 10 seconds with the L400 Line-Pro (4" x 5 mil), and much quicker with the L-1 Gas Line-Pro. Dual purpose: after spraying the parking lot lines, these versatile linemarkers can also be used for home and building maintenance. They spray all conventional paints such as latex, stain, alkyde, enamel, lacquer, and varnish, etc.

LINEMARKING EQUIPMENT



Save money and improve the appearance of your building and parking lot. Easy to use, they pump from the original 4 litre paint can (20 litre on the L-1 Gas and larger).

Spray height is easily adjusted for full line width control. (1" to 8" on the L400 series, and 2" to 14" on the L1 gas). The L-400 series are built tough for commercial use. Long life pump features a ceramic cylinder, tungsten piston, and a ceramic valve cone.

Professional results. Airless flat spray pattern gives a clear sharp edge without using shields. Commercial flat spray nozzles for long life. Use professional road marking paint, or regular latex and alkyde paints.

3) L-1 Line-Pro. This heavy duty commercial system is excellent for parking lots, side roads, playing fields, detours, and crosswalks. With the second gun option, it is capable of spraying two 14" lines! The guns are fully adjustable for left or right side operation, and for angle curb spraying. Balanced for best control and straightest lines. Dual purpose: after spraying parking lot lines, this versatile linemarker can also be used for home and building maintenance. Spray all conventional paints such as latex, stain, alkyde, enamel, lacquer, and varnish, etc. Weighs only 135 lbs, powered by a 4hp Honda.

Specifications:

Maximum tip025 (.68 gpm @ 2000 psi)
Maximum pressure	variable 0 - 3200 psi
Motor size	4.0 hp
Power transmission	V-belt
Bare weight	135 lbs / 61 kg
L-1 Line-Pro	L005-111

LEMMER

CONCRETE REPAIR MORTAR



Duro-Crete

High performance, pre-packaged, concrete repair mortar for partial depth repairs.

Duro-Crete is a rapid setting, cementitious repair mortar containing hydraulic cements, well graded, natural, fine aggregate and other carefully selected components.



Duro-Crete CT

High performance, pre-packaged, concrete repair mortar for cold temperature applications.

Duro-Crete CT is a rapid setting, cementitious repair mortar containing hydraulic cements, well graded, natural, fine aggregate and other carefully selected components for temperatures above 0°C (32°F).



Duro-Crete UW

High performance, pre-packaged, concrete repair mortar for underwater applications.

Duro-Crete UW is a rapid setting, cementitious repair mortar containing hydraulic cements, well graded, natural, fine aggregate and other carefully selected components for underwater concrete repair applications.



Redi-Plug

Pre-packaged, fast-setting concrete repair mortar containing industrial hydraulic cements.

Redi-Plug is designed to set within 30 seconds under normal jobsite conditions.

HIGH FREQUENCY PNEUMATIC INTERNAL CONCRETE VIBRATORS

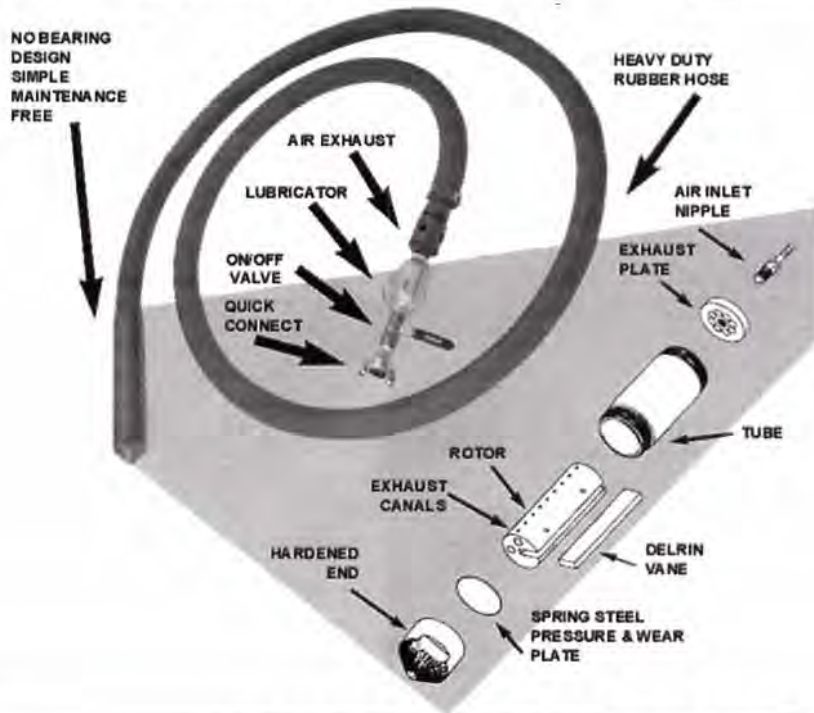

	KA 1-3/8	KA 1-3/4	KA 2-1/2	KA 3
HEAD DIAMETER*	1-3/8" 35	1-3/4" 45	2-1/2" 64	3" 76
HEAD LENGTH*	10-3/4" 273	11-1/2" 292	13" 330	15" 381
TOTAL LENGTH W/HOSE (H)*	11'9-3/4" 3600	11'10-1/2" 3620	12" 3658	12'2" 3708
TOTAL WEIGHT LBS / KG	14 6.4	18 8.2	25 11.3	32 14.5
RADIUS OF EFFECTIVENESS*	10 254	14 356	16 406	18 457
OUTPUT MAX CU. YD / HR**	20 15.3	35 26.8	40 30.6	42 32.1
MAX AGGREGATE SIZE*	1" 25	1-5/8" 42	2-1/4" 57	2-1/2" 64
AIR CONSUMPTION / CFM	21.5	26	36	40
FREQUENCY (VPM)	18,000	17,000	16,000	16,000
FORCE OUTPUT LBS. / N	450 2002	800 3560	2100 9345	3200 14239

* FIRST COLUMN INCHES; SECOND MM

** SECOND COLUMN CU. METER / HR.

THE PROFESSIONAL FOAM SYSTEM



REUSABLE!

Saves money. Eliminates waste. Store unfinished cans for up to a month for reuse. "Plug" in the straw when finished and save it for another day.

More Benefits!

■ **Minimal Expansion**

Great for sealing around windows and doors.

■ **Elastic Properties**

Foam will expand and compress with the shifting of structures from winter to summer. EnerFoam will not crack like other rigid foams.

■ **Works in Temperatures of 25°F to 120°F (-4°C to 49°C)**

EnerFoam stored at room temperature can be dispensed in a wide temperature range. Many other brands only work in 60°F to 90°F (16°C to 32°C).

■ **Quick Cure Time**

Fast cure time means you can foam and trim in less than one hour. Initial skin time is less than six minutes! Faster than any other foam.

■ **Insulator, Air Barrier, Acoustical Sealant**

R-value of 5.7 (more than most windows themselves). Acoustical rating of 69 STC.

■ **Independent Lab Tests**

Conforms to ASTM C557-93 (drywall adhesive). U.L. Class 1 rated (Flame spread of 15, smoke developed 20).

OTHER GREAT PRODUCTS...



NEW RAPID TAP CUTTING LIQUID



PAINT THINNER

**WINDSHIELD WASHER
 4 LITRES CONTAINERS
 AND
 205 LITRES DRUM**



METAL CUTTING

COOLCUT™ METAL CUTTING LUBRICANTS



A high performance cutting lubricant for all machining and chip removing operations in all ferrous and nonferrous metals. Excellent for drilling, sawing, milling, turning, reaming and broaching. Extends cutting tool life and produces a better finish. Solvent-free, no chlorine.

Better performance under all conditions

- 3 separate lubricity formulations provide overlapping protection against film breakdown in all metal cutting operations
- Low temperature lubricant protects cutting edge during start up
- Extreme pressure lubricity package allows for heavier chips and increased feed in difficult materials



Coolcut™ is available in solid stick and now in new gel form. Typical applications include cutting off with circular chop saws, drilling, tapping, jig sawing, nibbling, shearing and portable band sawing. Ideal for cutting sheet metal. Clean and pleasant to use. Sticks to cutting edge or the workpiece.

ORAPI



Specialty Metalworking

- Layout Fluid - Toolmakers' Ink
- Remover for Layout Fluids
- Bearing Blue - Blue Dye Spotting Ink
- Target Tap Premium Cutting Fluid
- Target Safe Cutting Fluid
- Target Tap Aluminum Cutting Fluid
- Tap All Cutting Fluid
- Ultra Cut Cutting Oil - Water emulsion type
- Ultra Grind Synthetic Coolant - Water Soluble
- Thread Cutting Oil
- Flaw Inspection Kit
- Replacements for Target Flaw Inspection Kit
- Flaw Inspection Chemicals - Nuclear grade



Specialty Lubricants



- Moly Lubricant - Dry Film
- Moly Lubricant - Grease
- Moly Lubricant - Open Chain Oil
- Moly Lubricant - Paste
- Graphite Lubricant - Dry Film
- Silicone Lubricant
- TFE Lubricant - Dry Film
- Sure Turn Anti-Seize Compound - Copper Base
- Sure Turn Anti-Seize Compound - Pure Nickel Base
- Heavy Duty Open Gear and Wire Rope Lubricant
- Chain and Cable Grease
- Sure Tite PTFE Paste

Specialty Cleaners and Degreasers

- Mold Cleaner
- Safety Solvent - Electric Motor Cleaner
- Electro Contact Cleaner
- Electrical Degreaser
- Engine and Machinery Degreaser
- Motor Shampoo
- Glass Cleaner
- Cleaner Concentrate - Multi-Purpose
- Single Seven Rust Remover



Specialty Coatings

- Sure Grip Belt Spray
- Mold Release - Paintable
- Tool and Die Saver
- Never Rust
- Welder's Anti-Spatter
- Cold Galvanizing Compound



OF CANADA LTD.



A World Leader in

Anti-Seize Compound,

Thread Sealant,

Lubrication &

Coating

Technology

Product List

Drilling Compounds
& Completion Compounds

Anti-Seize Compounds

Thread Sealants

E.P. Greases

Lubricants

Food Grade Products

Penetrants & Coatings
Cleaners & Degreasers

Marine Products

Anaerobics

Valve Sealants,
Lubricants & Related Products

DETAILED SPECIFICATION SHEETS AND MSDS's ARE
AVAILABLE FOR ALL PRODUCTS UPON REQUEST



The invisible all-around lubricant

Jig-A-Loo is a revolutionary new product that combines the power of a lubricant with the properties of a water-repellent.

It's a dry silicone-based lubricant that, unlike any other lubricant, contains **no oil, grease, wax, petroleum distillates or detergent**, so it **doesn't stain or stink**. It stops squeaks, un-sticks just about anything, protects against rust, and is an exceptional water repellent.

Jig-A-Loo is ideal for wood, metal, glass, rubber, leather, fabrics, most plastics and a number of other surfaces, helping just about anything operate and slide better. With thousands of uses around the house, garden, workshop, boat, campground and more, it's The Can of All Trades™.

Sizes available 10.9 oz and 3 oz



Super Grease The ultimate heavy-duty lubricant

Super Grease is a heavy duty, high performance white lithium grease. It won't melt, run, wash off or freeze. It's perfect for the DIY or industrial use.

Especially useful for metal-to-metal friction, like hinges, springs, or any other location where grease is needed.

Good in temperatures from -45°C to 175°C

Size available 10.9 oz (311 g)



2 Cycle Oil

Superior "low ash" lubrication for two cycle engine requiring up to and including 50:1 gas/oil mixtures. Reduces spark plug fouling. Ideal for lawnmowers, chainsaws, snowblowers and small outboards.



STOCK NO	SIZE	PER CASE
501	250 mL	24
504	500 mL	12

Eco-Care Multi-Kleen

Environmentally safe, water soluble biodegradable multi-purpose cleaner/degreaser with the fragrance of citrus fruit. This heavy duty degreaser provides fast, effective cleaning action.



STOCK NO	SIZE	PER CASE
017	4 L	4
018	20 L	1

Kleen-Start Starting Fluid

A priming fluid formulated to spray at extreme sub-zero temperatures. Effective to -53C (-63°F). Can is designed to fit all standard injection brackets. Instantly starts all types of gasoline and diesel engines. Contains an upper cylinder lubricant to reduce dry-start engine wear.



STOCK NO	SIZE	PER CASE
730	211 g	24

Air Tool Oil

This special formula has been engineered for the maintenance of all piston-type and rotary air tools. Kleen-Flo Air Tool Oil ensures longer tool life and smoother starting by dissolving gums and sludge.



STOCK NO	SIZE	PER CASE
4168	4 L	4
4169	500 mL	24

ergo.[®] Threadlocker

Bolts and nuts are normally used to fix two or even more parts together and to protect them against movement. By applying an on-torque, the bolt gets tensioned and keeps the parts into position.

Due to dynamic loads in axial and/or transversal directions, relative movements between bolt and nuts and the following decrease of preloaded on-torque can cause a loss of tension. Decreasing tension will be the consequence, which finally leads to failure of the bolted connection.

In order to avoid this behavior, bolted connections have to be secured. The use of mechanical devices, such as toothed lock washers, spring washers, pins etc. do rarely or not at all meet the high long-term requirements.

Another disadvantage of mechanical devices is the difficult stock-keeping procedure, due to the different diameters and various kind of bolts and nuts. Further, the use of those mechanical parts may damage the surface of assembled parts and may cause corrosion.

ergo.[®] threadlocking products are applied in liquid form directly on the thread and cure after assembly to a tough, thermoplastic or even thermosetting film. It completely fills the space between the threads and leads to an absolute form closure.

ergo.[®] threadlockers are available in various grades of strength, viscosity and cure speed for reliable joints without any additional devices.

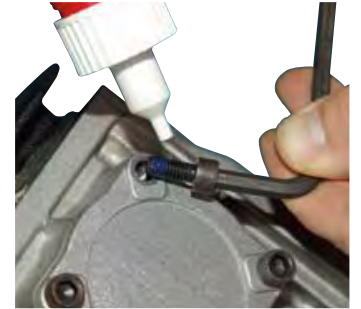

Threadlocking screws on a compressor casing

The patented ergo twist and dispensing cap

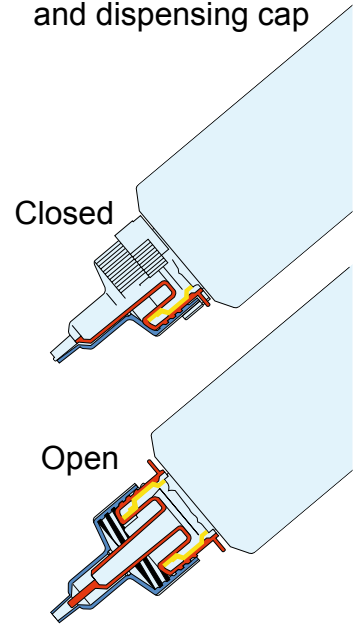

ergo.[®] Threadsealing / Hydraulic and pipe sealant

In practice, threaded metal pipe connections have to meet tightness requirements that common sealants cannot provide in all cases. At high pressures, in the presence of aggressive chemicals, especially together with extreme vibrations, annoying and expensive leakages are the results.

ergo.[®] pipe sealant compounds are available in various grades of viscosity and strength, for application on fine and coarse threads. These materials provide lubricity for more reliable torque rates during assembly and instant sealing for low pressure testing. It also prevents corrosion and galling on stainless steel assemblies.

ergo.[®] threadsealants ensure that perfectly sealed and secured joints can be obtained despite simple assembly techniques.

In order to achieve a fully sealed and pressure resistant joint up to the burst strength of the piping system, it is essential to cut the threads according to the standard, to completely fill the threads completely with the liquid sealant, to tighten them firmly and to leave them without any movement until the product is finally cured. Attention do not overtighten!

The cured adhesive film is resistant against vibration and resists to most industrial gases and fluids. ergo.[®] thread sealants are available in convenient and user-friendly containers. They can be applied directly onto the threads.

Caution: This products are not recommended without preliminary tests for use on copper or copper alloys which are in contact with hot water (>40°C) as well as in pure oxygen and/or oxygen rich systems and should not be used as a sealant for strong oxidizing materials.

Plastic threads usually require a different type of sealant than metal threads.



Application of ergo.[®] hydraulic and pipe sealant in plant construction

Product overview of Anaerobic adhesives

ergo. [®] type											
	Strength grade	Colour	Viscosity ¹ mPas	Breakaway torque Nm DIN 54454	Prevailing torque Nm	Compression shear strength N/mm ² DIN 54452	Tensile strength N/mm ²	Max. gap /thread	Temperature range °C	Final strength at 25°C after h	Approved by
4001 Threadlocker, low strength	low	brown	230	7	2	4	-	0.10 mm M 12	-55 up to +150	12	-
4003 Threadlocker, low strength	low	purple	1000	9	4	7	-	0.2 mm M 36	-55 up to +150	10	-
4050 Threadlocker, medium strength	medium	blue	180	18	10	12	-	0.15 mm M 12	-55 up to +150	10	-
4052 Threadlocker, medium strength	medium	blue	2500	25	7	20	-	0.25 mm M 36	-55 up to +150	3	NSF/DVGW
4100 Threadlocker, high strength	high	red	1500	>30	32	>20	-	0.25 mm M 36	-55 up to +150	3	NSF
4101 Threadlocker, high strength	high	green	700	>30	36	>20	-	0.15 mm M 20	-55 up to +150	10	NSF
4115 Threadlocker, heat resistant and high strength	high	red	10000	>23	25	>25	-	0.20 mm M 36	-55 up to +200	24	-

4202 Hydraulic sealant medium strength	medium	brown	575	20	9	15	-	0.15 mm 3/4"	-55 up to +150	6	-
4203 Hydraulic sealant low strength	low	violet	17000	7	1.5	2	-	0.15 mm 3/4"	-55 up to +150	24	-
4205 Pipe sealant with Teflon^{®2} low strength	low	white	17500 tx	12	3	5	-	0.30 mm 3"	-55 up to +200	12	NSF/KTW DVGW
4207 General purpose pipe sealant medium strength	medium	yellow	23000 tx	17	6	10	-	0.50 mm 3"	-55 up to +150	6	NSF/DVGW
4208 Pipe sealant, high strength	high	red	2500	>35	30	>27	-	0.20 mm 2"	-55 up to +175	24	-
4209 Pipe sealant, high strength	high	red	6500	>30	40	>20	-	0.30 mm 2"	-55 up to +150	24	NSF/DVGW
4211 Pipe sealant, heat resistant, medium strength	medium	violet	5000	25	8	15	-	0.20 mm 2"	-55 up to +175	24	-
4212 Pipe sealant with Teflon^{®2} low strength	low	white	240000 tx	9	1.5	3	-	0.50 mm 3"	-55 up to +150	24	NSF/DVGW



Application of gasketing compounds



ergo.[®] 4205 pipe sealant on measuring and cooling water fittings in the cold water area



Application of an ergo.[®] retaining compound on heating systems



Special properties	Size of packing in grams	Details on page	ergo. [®] type
ergo.[®]			
Threadlocker for easy disassembly and adjustment of threaded joints.	50/250	41	4001
General purpose product for easy disassembly of threaded joints. Locks adjusting screws with fine pitch threads. Nuts and bolts can be used "as received".	10/50/250	41	4003
Medium strength product. Suitable for fine pitch thread. Disassembly with normal tools.	50/250	42	4050
General purpose, medium strength product that also fills gaps due to its higher viscosity. Especially suited for stainless steel and galvanized fasteners. Relatively insensitive to unclean surfaces.	10/50/250	42	4052
For permanent locking of threaded fasteners. Fastens stud bolts reliably. Fasteners can be used "as received".	50/250	43	4100
High strength, general purpose threadlocker. Very well suited for high stress and heavy duty applications.	10/50/250	43	4101
High strength, high heat resistant threadlocker. Good gap filling to its high viscosity. Difficult to disassemble.	50/250	43	4115
Medium strength product for sealing pneumatic and hydraulic threaded joints up to 3/4". Seals up to the burst strength of the pipe system.	50/250	45	4202
Medium strength product for sealing pneumatic and hydraulic threaded joints up to R 3/4". Can be used on fittings "as received". Seals up to the burst strength of the pipe system.	50/250	45	4203
Filled with Teflon ^{®2} , heat-resistant pipe sealant with a low coefficient of friction. Resistant against chemicals.	50/250	45	4205
General purpose, medium strength pipe sealant. Resistant against natural gas. Well suited for stainless steel threaded joints.	50/250	45	4207
High strength pipe sealant for use on non ferrous metals and aluminium alloys with a good resistance against heat and chemicals. Also suitable as a retaining compound.	50/250	46	4208
General purpose, high strength pipe sealant with very good resistance against chemicals. Good gap filling capacity.	50/250	46	4209
High viscosity, medium strength sealing compound with excellent resistance against heat and hot water.	50/250	46	4211
For sealing threaded pipe connections and coarse threads against liquids, gases and solvents. No post-curing at higher temperatures. Solvent-resistant.	50/250	47	4212

▼ Threadlockers



LOCTITE® Low Strength Threadlocker PURPLE

- OEM specified as 222
- low strength threadlocker
- designed for fasteners M6 (1/4") and smaller
- removable with hand tools and normal effort

Applications: Set screws, headlamp screws and any small screw assembly.

P/N	Container
22200	10ml carded tube



LOCTITE® Removable Strength Threadlocker BLUE

- OEM specified as 242®
- removable strength, general purpose threadlocker
- designed for fasteners M6 (1/4") or larger
- removable with hand tools and normal effort

Applications: Oil pan bolts, water pump bolts and any similar threaded assembly.

P/N	Container
24200	6ml carded tube
24240	36ml carded bottle
24283	60ml bottle



LOCTITE® Removable Strength Threadlocker BLUE

- OEM specified as 243
- Loctite's Worldwide available, removable strength, general purpose threadlocker
- designed for fasteners 6mm (1/4") or larger
- designed to work better with oily parts
- removable with hand tools and normal effort

Applications: Oil pan bolts, water pump bolts and any similar threaded assembly.

P/N	Container
24300	10ml carded bottle



LOCTITE® Permanent Strength Threadlocker RED

- OEM specified as 262
- permanent threadlocker
- designed for locking fasteners M6 (1/4") and larger
- withstands heavy shock and vibration
- extra effort and localized heat may be required for removal

Applications: Shock mounts, suspension bolts and studs, and similar fasteners subject to higher shock and vibration.

P/N	Container
26200	6ml carded tube
26240	36ml carded bottle
26283	60ml bottle



PERMATEX® Aviation FORM-A-GASKET® No. 3 Sealant



PERMATEX® INDIAN HEAD® Gasket Shellac Compound



PERMATEX® SUPER "300"® FORM-A-GASKET® Sealant



PERMATEX® OE Type FORM-A-GASKET® Sealant

NEVER-SEEZ



WD-40



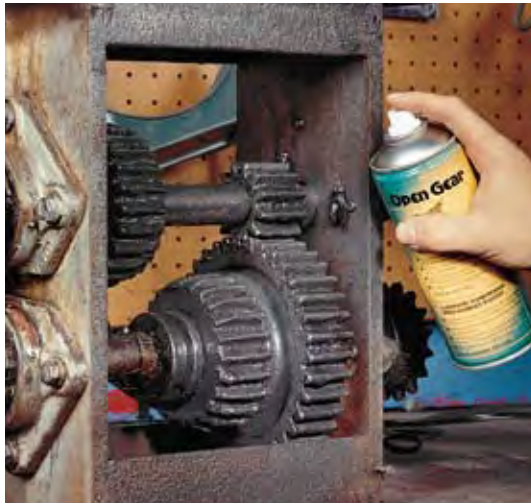

Open Gear™ HIGH LOAD DRIVE LUBRICANT

Adherent, long lasting, high load gear grease that prevents metal-to-metal contact to increase efficiency and service life of drives and gears even in harsh environments.

APPLICATIONS

- ▶ All types of drives and gears
- ▶ Machinery
- ▶ Forklifts
- ▶ Also effective on wire ropes

BENEFITS

- ▶ Contains “Moly” and EP additives for high load lubrication
- ▶ Resists up to 90,000 lbs/sq.in.
- ▶ Will not fly off nor attract dirt particles
- ▶ Water-resistant
- ▶ Working temperature: -20°C to 180°C (-5°F to 360°F)



Description	Size		Order No.	MSDS	Std. Pkg.
	Metric	Imperial			
Aerosol	400 ml	13.5 oz.	53-E 102	L-16E	12

Cutting lubricants

Coolcut™ METAL CUTTING LUBRICANT

High performance metal cutting lubricant stands up to pressure and heat to reduce tool wear, prevent tool breakage, increase production rates and improve surface finish.

APPLICATIONS

- ▶ For all machining operations: drilling, sawing, tapping, milling, reaming, broaching, nibbling and shearing
- ▶ Suitable for steel, stainless steel, tough alloys and all other ferrous and non-ferrous metals

BENEFITS

- ▶ Reduces friction and heat for longer tool life and better finish
- ▶ Allows increased feed rates and higher speeds to save time
- ▶ Contains no chlorinated waxes or chlorine



Description	Size		Order No.	MSDS	Std. Pkg.
	Metric	Imperial			
Solid stick	300 g	10.5 oz.	53-B 013	L-22E	12
Sprayer	500 ml	16.9 oz.	53-B 004	L-113E	12
Paste	200 g	7 oz.	53-B 023	L-52E	12
Aerosol (Gel)	312 g	11 oz.	53-B 002	L-01E	12
Squeeze bottle	350 ml	11.8 oz.	53-B 003	L-09E	12
Liquid	5 L	1.3 gal.	53-B 006	L-09E	1
Liquid	20 L	5.2 gal.	53-B 007	L-09E	1
Liquid	208 L	55 gal.	53-B 008	L-09E	1

ACCESSORIES	Order No.
Spout for 5 L pail	53-L 113
Spout for 20 L pail	53-L 207
Faucet for 208 L drum, 2"	53-L 209
Spout for 208 L drum, 3/4"	53-L 210

Bio Clean™ NATURAL CLEANER / DEGREASER

This powerful alternative to petroleum-based cleaners is all natural and fast acting.

APPLICATIONS

For the removal of:

- ▶ Labels, adhesive and sealant on parts or containers
- ▶ Tape and tire marks on floors
- ▶ Tar, grease and dirt in fleet maintenance
- ▶ Wood pitch, rubber, resin and glue residues on saw blades, machines and conveyors

BENEFITS

- ▶ Contains a very high concentration of d-Limonene
- ▶ Safe on all metals and most plastics
- ▶ Non-corrosive, biodegradable



CLEANING & DEGREASING



Description	Size		Order No.	MSDS	Std. Pkg.
	Metric	Imperial			
Sprayer	500 ml	16.9 oz.	53-G 513	L-68E	12
Liquid	3.78 L	1 gal.	53-G 516	L-68E	1
Liquid	20 L	5.2 gal.	53-G 517	L-68E	1
Liquid	200 L	52.8 gal.	53-G 518	L-120E	1

ACCESSORIES

	Order No.
Industrial pump sprayer	53-L 120
Spout for 20 L pail	53-L 208
Spout for 200 L drum	53-L 208
Replacement trigger sprayer bottle, 500 ml	53-L 313

Slap Shot™ INDUSTRIAL PARTS CLEANER / DEGREASER

This highly effective, residue-free and fast evaporating cleaner/degreaser dissolves and removes grease, oil and grime on contact.

APPLICATIONS

- ▶ Removal of glue, paint, ink, resin and sealant residue
- ▶ Removal of plastic foil and wax-like protective coatings
- ▶ Cleaning of ferrous and non-ferrous metals



BENEFITS

- ▶ Strong jet blasts away grease and grime
- ▶ Powerful to quickly and completely dissolve stubborn dirt and grease without leaving any residue
- ▶ Free of chlorinated solvent



Description	Size		Order No.	MSDS	Std. Pkg.
	Metric	Imperial			
Aerosol	500 ml	16.9 oz.	53-C 502	L-39E	12
Sprayer	500 ml	16.9 oz.	53-C 503	L-40E	12
Liquid	5 L	1.3 gal.	53-C 506	L-40E	1
Liquid	20 L	5.2 gal.	53-C 507	L-40E	1
Liquid	200 L	52.8 gal.	53-C 508	L-40E	1

ACCESSORIES

Spout for 20 L pail	53-L 208
Spout for 200 L drum	53-L 208
Replacement trigger sprayer bottle, 500 ml	53-L 311

GENERAL CLEANERS



WINDEX

•INSTITUTIONAL STRENGTH GLASS CLEANER
Powerized formula, a special & unique blend for commercial & institutional use. Leaves no streak or film

DR90139 DR90940 DR90122 DR90129
12x946ml. 4x3.78 L. 19 L. 12x567gr.



FANTASTIK

•ALL PURPOSE CLEANER
Reputable, ready to use all purpose cleaner. For quick & easy removal of dirt and stains.
code: DR95623 DR95625
format: 12x700ml. 4x5 L.



•12% CONCENTRATED JAVEL WATER
Cleans, disinfects, deodorizes & bleaches. Use for whitening & for disinfecting potable water, septic tanks, pools etc.



SAVO

•15% PINK HAND SOAP
Pink hand & dish soap. Effective & economical. Produces an abundant foam. Biodegradable & phosphate free.
code: CHROSE CHROSE5
format: 4x4 L. 20 L.



NUTRAL

•NEUTRAL FLOOR DETERGENT
Concentrated & pleasantly scented, with excellent emulsifiers & penetration agents. Enhances tile gloss.
code: CHNEUT CHNEUT5
format: 4x4 L. 20 L.

BIO-SOL #1



BIO-SOL # 1 is a 100 % liquid active degreaser. It contains natural and biodegradable solvents and emulsifiers. **BIO-SOL # 1** is used to clean cement surfaces (floors, walls, etc.) and it can be used as motor shampoo and industrial parts cleaner.



DL® PERMATEX® Blue Label™ Cream Hand Cleaner

- petroleum solvent-based cream formula waterless hand cleaner
- gentle to hands, leaves no greasy feeling after use
- cited by a leading consumer magazine as the best performing waterless hand cleaner

Applications: Oil, grease, tar, grime, soil, resins, printer's ink, epoxies, paint, rubber, gaskets and tile cement.

P/N	Container
01-013	400g can
01-406†	2kg can
01-202	20kg pail



DL® PERMATEX® Fast Orange® Fine Pumice Lotion Hand Cleaner

- the leading biodegradable, waterless, petroleum solvent-free pumice hand cleaner
- contains no harsh chemicals, mineral oils or ammonia that can sting cuts and abrasions
- pure, fresh-smelling natural citrus power does the cleaning
- contains aloe, lanolin, jojoba and Corn Huskers Lotion®* for added skin conditioning and protection
- fine pumice formula gently deep cleans the toughest dirt

Applications: Cleans grease, grime, oils, glues, gasket and tile cements, printers ink, paint, and tar from hands. Also works great on laundry stains, scuff marks, tile floors, and other household cleaning needs.

Insect Repellent

Muskol

Aerosol 200g

Muskol® Insect Repellent has a long heritage of providing effective protection against mosquitoes. Developed in 1951 by Col. T. Coll, an avid Canadian outdoorsman, Muskol® Insect Repellent provides eight hours of effective protection against mosquitoes. Also repels black flies, biting midges, deer flies, stable flies, ticks and chiggers.

Convenient, no-mess Muskol® Insect Repellent Aerosol 200g provides better and easier coverage of hard-to-reach places like ankles, legs and back.

GUARANTEE: DEET 23.5%

DIRECTION FOR USE

Do's

Select aerosol and pump-spray products for broad and even application of repellent on both clothing and skin.

Select liquid, cream or lotion products to apply repellent in exact locations where protection is desired.



Pump Spray 50ml

Muskol® Insect Repellent Pump Spray 50ml is a formula that offers eight hours of protection against mosquitoes with just one application. Small enough to fit in a pocket or backpack.

GUARANTEE: DEET plus related active toluamides 30%

DIRECTION FOR USE

Do's

Select aerosol and pump-spray products for broad and even application of repellent on both clothing and skin.

Select liquid, cream or lotion products to apply repellent in exact locations where protection is desired.

After your outdoor activity, wash treated skin with soap and water.

Use only as directed on the product label.



Classic Liquid 40ml

Muskol® Insect Repellent Classic 40ml is a formula that offers eight hours of protection against mosquitoes with just one application. Provides better and easier coverage of hard-to-reach places like the ankles, legs and back. Small enough to fit in a pocket or backpack.

GUARANTEE: DEET plus related active toluamides 30%

DIRECTION FOR USE

Do's

Select aerosol and pump-spray products for broad and even application of repellent on both clothing and skin.

Select liquid, cream or lotion products to apply repellent in exact locations where protection is desired.

After your outdoor activity, wash treated skin with soap and water.

Use only as directed on the product label.



SANITARY PRODUCTS

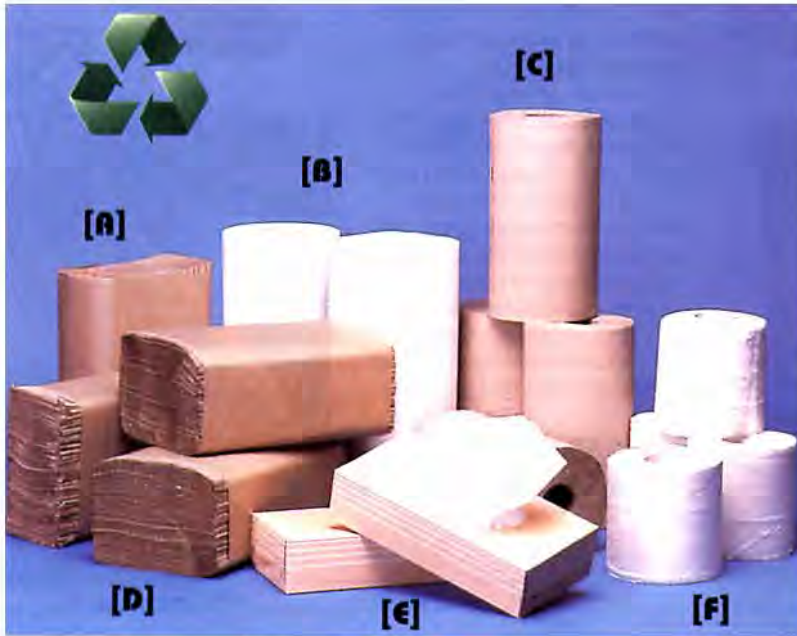

[A]



Available in white and chrome



KIMTOWELS® WIPERS

[A] INDUSTRIAL MULTIFOLD BROWN PAPER TOWELS

- Packed in stacks for use in singlefold/multifold dispensers
- Size: 9 1/2" x 9 1/2"
- 4000 towels per case
- Available in white; minimum quantities apply

[B] PROFESSIONAL WIPER TOWELS

- 2-ply white commercial jumbo sheets
- Embossed surface provides excellent absorbency
- 90 perforated sheets per roll, 24 rolls per case wrapped in cellophane

[C] INDUSTRIAL BROWN PAPER TOWEL ROLLS

- Size: 8" or 10" wide x 205'; 24 rolls per case
- Available in white; minimum quantities apply

[D] INDUSTRIAL SINGLEFOLD BROWN PAPER TOWELS

- Packed in stacks for use in universal or singlefold/multifold dispensers
- Size: 9 x 10 1/4"
- 4000 towels per case
- Available in white; minimum quantities apply

[E] FACIAL TISSUE

- 2-ply provides comfort and strength
- Size: 19 1/2 x 23 cm, 100 tissues per box, 36 boxes per case

[F] 2-PLY BATHROOM TISSUE

- Soft tissue
- Premium tissue individually wrapped for safe, clean, sanitary storage

PAPER TOWEL DISPENSERS

- Provide clean, dust-free paper towels quickly and easily
- Dispensers for rolls help reduce waste and cost by providing sheets at the desired length—simply pull and tear off
- Eliminate the common problem of wet or soiled towels that result when rolls are unrolled with wet hands
- Singlefold and multifold models provide hygienic sheets individually

[A] UNIVERSAL TOWEL DISPENSER

- Combination cabinet for rolls up to 6" in diameter or standard singlefold towels
- Available in white or chrome
- Size: 9 1/2" H x 10 1/2" W x 6 1/4" D

[B] MULTIFOLD TOWEL DISPENSER

- Holds up to 500 towels
- Tamper-proof safety lock prevents pilferage
- Available in white or chrome
- Size: 10 1/2" H x 10 1/2" W x 4" D

Item	Model
[A]	Universal White
[A]	Universal Chrome (Not shown)



•PUSH BUTTON DISPENSERS

Translucent 48 oz. capacity soap dispenser for liquid & lotion soap. Easily removed container for quick maintenance ease.

F1215-BL 48 oz. Blanc / White
F1215-NR 48 oz. Noir / Black

Item	Description	Qty/Case
[A]	Multifold	4000 towels
[B]	Wiper towels 11"	24 rolls
[C]	8" roll	24 rolls
[C]	10" roll	24 rolls
[D]	Singlefold	4000 towels
[E]	Facial tissue	36 boxes
[F]	Bathroom tissue (420 sheets)	48 rolls

Floor Sweeps

Requires a threaded handle.

Fine Floor Sweeps

- Ideal for highly polished or waxed floors.
- Available in flagged polypropylene or blended hair/tampico for removing fine dirt and dust.
- Two threaded handle holes on block.

Medium Floor Sweeps

- Long-lasting polypropylene bristles remove heavier dirt and debris.
- Natural tampico bristles work well on both rough wood and smooth floor surfaces.
- Indoor/outdoor model moves both heavy and fine dirt.

Heavy-Duty Floor Sweeps

- Heavy-duty polypropylene bristles designed for use in the most demanding industrial applications.
- Tampico bristles lift grime and embedded dirt.
- Natural palmyra for effective use on rough surfaces.



Dimensions

- 18" - 24" - 30" - 36"
- 18" - 24" - 30" - 36"
- 18" - 24" - 30" - 36"

Window, Truck and Wall Brushes

- Available in flagged synthetic fibers to help avoid scratching or natural tampico for absorbing cleaning solution.
- Plastic blocks resist splitting or delaminating.
- Can be used with flow-through handle.



352

349

347

9554 9054 9254



WOOD HANDLES
THREADED OR TAPER FIT

Barn/Street Brooms and Sweeps

For greater coverage and ease when sweeping close to walls or curbs.

- Washable polypropylene bristles for long service.
- Natural palmyra for rough barn or street sweeping.
- Requires a tapered handle.



14" 5014
16" 5016

Corn Brooms

Designed for rugged indoor/outdoor cleaning.

- 100% natural broom corn fibers for long life and effective pick up.
- Remove fine dirt from even or rough surfaces.
- Hand-selected, heavy-duty lacquered pine handles.

M - 3



ANGLED BROOMS



DUST PANS



WISK BROOMS



SWEEPING COMPOUND

Round Brute® Containers



2655/2650
For heavy loads or metal drums, use the Universal Drum Dolly for quick and easy transport.

Dura-Pro® Cotton Mops

- Economical, 4-ply cut-end mop for general purpose cleaning.

Description	Mop Size
Dura-Pro® 4-Ply Cotton Mop	16 oz./5 kg
Dura-Pro® 4-Ply Cotton Mop	20 oz./6 kg
Dura-Pro® 4-Ply Cotton Mop	24 oz./7 kg
Dura-Pro® 4-Ply Cotton Mop	32 oz./9 kg



Bucket/Wringer Combination Packs

Take the guesswork out of ordering mop buckets and wringers.

- One order number gets you both bucket and wringer.
- Non-marking casters for reduced touch-up cleaning.
- Multi-lingual "Caution" imprint to alert pedestrians in English, French, German and Spanish.



•WIDE RIB RUBBER MATTING

Indoor/outdoor carpet used where the floor protection and security is a vital importance. Will stay malleable even at low temperature contrary to vinyl. It's easy and fast to wash. The rubber matting has a thickness of 1/8" and is available only in black in 75 feet rolls.

code TCN24WR Rubber matting 24" wide
code TCN36WR Rubber matting 36" wide
code TCN48WR Rubber matting 48" wide

SQUEEGEE



•NEOPRENE BLADE METAL FRAME

Black neoprene blade. Available in 18", 24", 30", 36".

FS023 Complete squeegee
FS023R Blade only

•OIL-DRY® GRANULAR SORBANT

Economically formulated granular sorbant. Enables you to efficiently and securely recuperate liquid spills.

code: MS020-ABS
format: 18 kg.



DE-ICING SALT



GARBAGE BAGS

Guide to choose appropriate size (approximate)

Container	Garbage Bag
Up to 6 gal.	20 x 22"
7 to 17 gal.	26 x 36"
15 to 25 gal.	35 x 50"
Over 22 gal.	42 x 48"



RAGS

Colored rags in boxes of 25lbs.

White rags in boxes of 10lbs.



Canadian made products...
tailored to your specific needs!

CARPETS SOLUTIONS

SPECIALTIES



DURA-SHOCK™

Specialties (Gym/Horse Stalls)

Durable solution designed to give superior traction while muffling noise and vibration!

Characteristics

- Protects floors from free weights
- Made from 100% recycled rubber
- Two easy to clean reversible surfaces



TILE-LOCK™

Specialties (Gym/Horse Stalls)

Durable snap-together matting protects floors and allows custom installations!

Characteristics

- Simple to install and accommodates most areas
- Absorbs shock and noise
- Excellent traction with pebble textured surface that is easy to clean



GYM-DANDY™

Specialties (Gym/Horse Stalls)

Economical, temporary solution to protect floors during special events!

Characteristics

- Cost-effective solution to protect floors from dirt and stains
- Slip-resistant and fire-retardant PVC foam
- Simple to install with our Gym-Dandy™ Caddy



ELECTRICALLY CONDUCTIVE DECK PLATE

Specialties (Anti-static)

Electrically Conductive Deck Plate quickly drains static charge to protect components and equipment!

Characteristics

- Static dissipative surface resistivity of 10^6 ohms per square
- Deck plate top surface enhances traction
- PVC foam backing allows good anti-fatigue relief while standing



COMFORT-KING™ ANTI-STATIC

Specialties (Anti-static)

Protects electronic components from damage! Anti-static, highly energized Zedlan™ foam helps discharge static while relieving fatigue !

Characteristics

- Static dissipative resistivity of 10^9 ohms per square
- Anti-static property also prevents the incidence of sparks caused by static
- Highly energized Zedlan™ sponge that combines softness, resilience and durability for exceptional relief

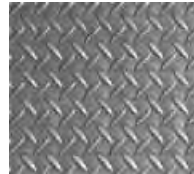

MILITARY DECK PLATE SWITCHBOARD RUNNER

Specialties (Non-conductive)

Insulated runner meets military spec Mil-DTL -15562G, Type 3 requirements!

Characteristics

- Vinyl textured surface for better slip resistance
- Flame-resistant; certified to Mil Std-1623
- Dielectric rating: 30,000 volts

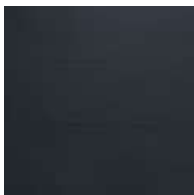

MILITARY SMOOTH SWITCHBOARD RUNNER

Specialties (Non-conductive)

Insulated runner meets military spec Mil-DTL -15562G, Type 2 requirements!

Characteristics

- Wear resistance: ASTM-D-1242
- Flame-resistant; certified to Mil Std-1623
- Dielectric rating: 30,000 volts



CORRUGATED SWITCHBOARD RUNNER

Specialties (Non-conductive)

V-groove non-conductive runner insulates worker to prevent shock!

Characteristics

- Deep grooved surface guards against slipping and traps dust and dirt particles within the mat
- Dielectric rating: 30,000 volts
- Meets ASTM standards: D178, Type 2, Class 2

PRO-TEKT™

Specialties (Runners)

Economical, pebble surfaced vinyl foam runner allows for a variety of uses

Characteristics

STAT-CONTROL™

Specialties (Anti-static)

CARPETS SOLUTIONS



- Cost effective slip-resistant and chemical-resistant floor protection



Smooth conductive surface with foam backing protects components from static damage!

Characteristics

- Static dissipative surface resistivity of 10^7 ohms per square
- Bevelled edges and smooth easy to clean vinyl surface
- PVC foam backing allows good anti-fatigue relief while standing



DECK PLATE

Specialties (Runners)

Distinctive raised-diamond pattern increases traction and durability

Characteristics

- Easy to clean surface is resistant to most common chemicals



STA-KLEEN™

Specialties (Runners)

Industrial grade round-rib vinyl runner for demanding environments

Characteristics

- Surface resists normal acids, alkalis, oil, grease and most organic solvents, if removed quickly



COREC™

Specialties (Runners)

Durable, economical V-groove vinyl runner that protects floors from heavy traffic

Characteristics

- Resistant to most commercial and industrial chemicals



TEXTURED RUBBER

Specialties (Runners)

Gnarled-textured runner provides excellent traction, while protecting floors

Characteristics

- Durable rubber surface is slip-resistant and resists abrasion



WIDE RIB RUBBER

Specialties (Runners)

Large rib runner provides excellent traction, while protecting floors

Characteristics

- Durable rubber surface is slip-resistant and resists abrasion



TUFF-SPUN® 1/8

Specialties (Runners)

Economical anti-fatigue runner reduces noise and breakage

Characteristics

- Dense closed-cell PVC sponge



ANTI-SLIP TRACTION PADS

Specialties (Others)

Self-adhesive, abrasive strips for inclines and wet areas. Easily applied to metal, primed concrete or wood

Characteristics

- Easy to install; just cut and place on clean, dry, oil-free surface



ENDURA™ COMFORT MAT

Specialties (Others)

Attractive anti-fatigue solution for upscale environments

Characteristics

- HDNP plush surface laminated to a rubber anti-fatigue sponge



CLOUD-10™

Specialties (Others)

Dual-layer ribbed anti-fatigue solution with bevelled edging

Characteristics

- Laminated PVC foam for increased durability



SAFETY MESSAGE MATS

Specialties (Others)

Increase awareness and reinforce safety policies with vibrant Safety Message Mats

Characteristics

- Keep floors clean and employees / visitors safe



SHOWER AND EYEWASH STATIONS

Specialties (Others)

Preassembled shower or eyewash stations have highly-visible colours to comply with industry standards: red for showers and green for eyewash stations

Characteristics

- Comes assembled and ready-to-use



Canadian made products...
tailored to your specific needs!

FLEXCO® BOLT SOLID PLATE

ORDERING INFORMATION

Fasteners Required For Various Belt Widths

Belt Width in. mm.	Fastener Size Nos. 1, 140 & 190		Fastener Size Nos. 1-1/2, 2, 2-1/4 & SP6		Fastener Size Nos. 2-1/2 & 3	
	90° in. mm.	45° in. mm.	90° in. mm.	45° in. mm.	90° in. mm.	45° in. mm.
12 300	10 9	12 12	8 8	9 10	6 6	7 7
18 450	15 14	19 19	12 11	15 15	9 9	12 12
24 600	20 19	26 26	16 15	21 21	13 13	17 16
30 750	25 24	33 33	20 19	27 27	16 16	21 21
36 900	30 29	41 40	24 23	33 32	19 19	26 26
1000	32	45	26	36	21	29
42 1050	35 34	48 47	28 27	39 38	22 21	31 30
48 1200	40 39	55 54	32 31	44 43	26 26	35 35
54 1350	45 44	63 61	36 35	48 49	29 29	40 40
60 1500	50 49	69 68	40 39	56 55	32 32	44 44
72 1800	60 59	83 82	48 47	68 65	39 39	53 53

"E" Box Fastener Sets

One "E" box contains 25 complete fastener sets. A set consists of a top plate, a bottom plate, two nuts, two bolts and an assembly clip. Four "E" boxes make up a shipping carton. See Multi-Pak Shipping Cartons on next page.

"E" Box Ordering Numbers*

Ordering Number	Item Code
Steel	
1E	20002
140E	20000
190E	20001
1-1/2E	20004
2E	20005
2-1/4E	20006
2-1/2	20007
3	20008
SP6E	20009
Stainless	
1ES	20036
140ES	20034
190ES	20035
1-1/2ES	20038
2ES	20039
2-1/4ES	20040
Stainless Top Plates (with Balance Steel)	
1EST	20120
140EST	20118
190EST	20119
1-1/4EST	20121
1-1/2EST	20122
2EST	20123

Ordering Number	Item Code
Monel®	
1-1/2EM	20064
2EM	20065
Monel® Top Plates (with Balance Steel)	
1EMT	20140
2EMT	20143
1-1/2EMT	20142
Everdur®	
1EE	20092
140EE	20090
190EE	20091
1-1/2EE	20094
2EE	20095
2-1/4EE	20096
MegAlloy® Top Plates (with Balance Steel)	
140EMA	20330
190EMA	20331
1-1/2EMA	20334
2EMA	20335
2-1/4EMA	20336

Ordering Number	Item Code
MegAlloy® Top & Bottom Plates (Steel Nuts & Bolts)	
140EMAP	20364
190EMAP	20365
1-1/2EMAP	20366
2EMAP	20367
Promal® Top Plates (with Balance Steel)	
1-1/2EP	20168
140EP	20164
190EP	20165
2EP	20169
Rubber-covered Top Plates (with Balance Steel)	
190ERCT	20188
1-1/2ERCT	20189
2ERCT	20190
2-1/4ERCT	20191

*NOTE: Ordering Number indicates fastener size.

"C" Container 100 Fastener Sets

A "C" container contains 100 fastener sets. The bottom plates are pre-assembled with bolts and clips. *NOTE: Ordering Number indicates fastener size.

"C" container Ordering Numbers*

Ordering Number	Item Code
Steel	
1C	20014
140C	20012
190C	20013
1-1/2C	20016
2C	20017
2-1/4C	20018
2-1/2C	20019
3C	20020
SP6C	20021

Ordering Number	Item Code
MegAlloy® Top Plates (w/Balance Steel)	
140CMA	20340
190CMA	20341
1-1/2CMA	20344
2CMA	20345
MegAlloy® Top & Bottom Plates (with Steel Bolts & Nuts)	
140CMAP	20370
190CMAP	20371
1-1/2CMAP	20372

*Other "C" containers of special metals are available on a "packaged-to-order" basis.



"E" Box



"C" Container

shop-vac INDUSTRIAL WET/DRY VACUUMS

MODEL 910-21



MODEL 910-19



MODEL 910-49



MODEL 910-50



MODEL 910-52



MODEL 991-01



Model No.	Description	Horsepower (HP)	Drum Size Imp. Gal.	Litres	Accessory Pack	Shipping Weight (lbs.)
910-19	Heavy Duty Wet and Dry Plastic Cannister Vac	1.5	5	22.7	P	17.5
910-21	Heavy Duty Wet and Dry Stainless Steel Vac	1.7	3.6	16.4	P	22
910-49	Heavy Duty Wet and Dry Stainless Steel Vac	1.7	4.8	21.8	A	23
910-50	Heavy Duty Wet and Dry Stainless Steel Vac	1.7	8	36.4	A	24
910-52	Deluxe Wet and Dry Stainless Steel Vac	1.7	16	72.7	A	60
991-01	Deluxe Wet and Dry Stainless Steel Vac	3.5	16	72.7	A	75

P Pack contains: 10' x 1 1/4" Hose with Curved Extension Wand with Positive Lock, Posi Lock Metal Wands, 10" Plastic Master Nozzle, 10" Squeegee Shoe, Dual Surface Nozzle, Crevice Tool, Round Brush, Upholstery Nozzle.

A Pack contains: 12' x 1 1/2" Hose, Interlocking Chrome Wands, 14" Metal Master Nozzle, 14" Squeegee Shoe, 14" Brush Shoe, 14" Rug Shoe.

MODEL 950-05



**MODEL 950-01
MODEL 950-03**



MODEL 950-04



MODEL 970-20



MODEL 970-21



Model No.	Description	Horsepower (HP)	Drum Size Imp. Gal.	Litres	Accessory Pack	Shipping Weight (lbs.)
950-01	Deluxe Wet and Dry Poly Tank	1.7	10	45.5	A	49
950-03	Deluxe Wet and Dry Poly Tank	2.5	10	45.5	A	49
950-04	Deluxe Wet and Dry Poly Tank	2.5	13	59.1	A	50
950-05	Deluxe Wet and Dry Stainless Steel Tank	2.5	8	36.4	A	26
970-20	Deluxe Wet and Dry Vac Metal Tank	2.5	44	200.0	None	85
970-21	Deluxe Wet and Dry - Head Assembly	2.5	N/A	N/A	None	28

A Pack contains: 12' x 1 1/2" Hose, Interlocking Chrome Wands, 14" Metal Master Nozzle, 14" Squeegee Shoe, 14" Brush Shoe, 14" Rug Shoe.



FUNNELS AND MESURES

Funnels

Heavy Galvanized Steel Funnels. Capacity indicates what the funnels will hold when the outlet is blocked.

Part No.	Description	Capacity	Total Height	Diameter	Tip OD
75-001	Utility funnel	1 quart	7"	7"	3/4"
75-002	Offset funnel, with screen	6 quarts	14"	9"	1 1/4"
75-003	Utility banded-top	2 quarts	8"	8"	3/4"
75-004	Regular tractor, with screen	8 quarts	12"	9 1/2"	1"
75-008	Funnel lock-on tractor, with screen and tabs	8 quarts	11 1/2"	10"	1 1/4"
75-015	Funnel	1 pint	5 1/2"	5"	3/4"
75-017	Funnel	7 pints	8 3/4"	9 3/4"	3/4"



Galvanized Measures

Galvanized Measures. Deluxe measures with spill proof tops. Angled spouts for ease of pouring. Rolled edge, easy grip handles. Calibrated fill line. Available in both rigid spout width 7/8" OD tip and flexible spout with 1/2" OD tip models.

Part No.	Spout	Capacity	Overall Height
75-401	Rigid	1 Quart	6 1/2"
75-402	Rigid	2 Quarts	9 1/2"
75-404	Rigid	4 Quarts	11"
75-441	Flexible	1 Quart	6 1/2"
75-442	Flexible	2 Quarts	9 1/2"
75-444	Flexible	4 Quarts	11"

LINCOLN LUBRICATING EQUIPMENT

HEAVY DUTY LEVER GUNS

Rugged, dependable and jam proof, Lincoln heavy duty lever guns offer that and more. We have designed our lever guns with your needs in mind. We feature guns in varying sizes and price ranges, and offer guns with a variety of features. All are rugged and built to last. Whatever you need, Lincoln has the lever gun for you.

MODEL 1142—A heavy-duty, high-pressure, grease gun with three-way loading, 6" extension and hydraulic coupler and 16 oz. bulk or cartridge lube capacity. Overall length is 21¾".

MODEL 1151—Same features as model 1142, but with 21 oz. capacity and 24½" overall length.

MODEL 1121—Rugged and reliable, large 14½ oz. cartridge or 16 oz. bulk capacity lever-action grease gun with three way loading and 10,000 psi maximum pressure.

MODEL 1013—Versatile, dual-pressure lever gun which features 360° swivel nozzle, high or low pressure volume delivery, pistol grip handle, 6" extension and hydraulic coupler, 16 oz. lube capacity and three-way loading. Overall length 22⅞".

MODEL 1145—Same features as model 1013, but has 21 oz. capacity and 25⅝" overall length.

MODEL 1035—Extra heavy-duty gun featuring 6" extension with heavy-duty coupler, 21 oz. bulk or cartridge capacity, three-way loading, nickel plated spring and forced primed. Overall length is 27¾".

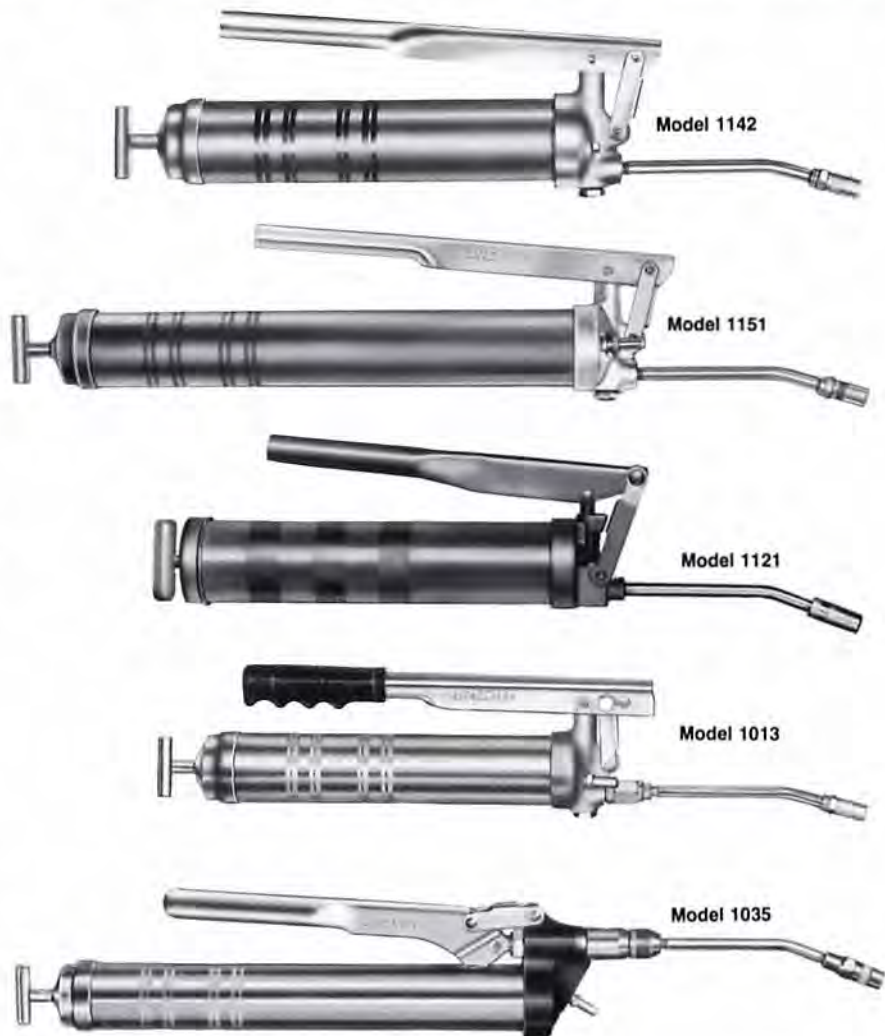

PISTOL GRIP GREASE GUNS



• HANDY 3 WAY LOADING

• EXCLUSIVE FLIP-OVER FOLLOWER

• RUGGED DIE CAST HEAD.

MODEL 1133—Easy to use, pistol grip grease gun with 18" flexible hose with hydraulic coupler, 16 oz. bulk or cartridge lube capacity,

MODEL 1132—Same as model 1133 but has 6" straight pipe with hydraulic coupler.

MODEL 1130—Same as models 1133 and 1132 but has no extension.

MINI GREASE GUN



MODEL 1138—A mini-grease gun with maximum performance features, all metal construction, builds up to 5,000 psi.

MODEL 1139—Set of three 3 oz. replacement grease cartridges.

FILLER NIPPLE



MODEL 91108—Filler nipple for converting old, hand guns to modern way of loading. Includes ball check: ⅛" N.P.T. male thread.

AIR OPERATED GREASE GUN



MODEL 1161—Pistol style, air operated grease gun with fixed and flexible extensions with hydraulic couplers, 50:1 ratio with air input of 30 to 150 psi. and 14 oz. cartridge or suction loading.

LINCOLN AIRLINE ACCESSORIES

SPRING OPERATED REELS



Model 83410

Air Reels

MODEL 83410—Reel and hose assembly. Includes 83408 reel, 83515 ball stop, 72012 connecting hose with 1/4" N.P.T. male thread & 72420 1/4" I.D. 35 ft. hose.

MODEL 83411—Reel and hose assembly. Includes 83408 reel, 83515 ball stop, 72012 connecting hose with 1/4" N.P.T. male thread & 72A300 3/8" I.D. 25 ft. hose.

SELF COILING AIR HOSE



Model 84606

MODEL 84606—Self coiling air hose of tough abrasive resistant material designed for working pressures up to 200 psi. 1/4" I.D. x 25' long. 1/4" NPT male fittings with coiled spring guards on both ends.

TIRE INFLATORS



Model 80423

MODEL 80423—Gauge type tire inflator. Dual chuck, truck gauge for dual tires. Extension cap permits use on passenger cars. Includes 11659 nipple for use with 815 coupler. 0-120 p.s.i. scale in 2 p.s.i. graduations.



Model 66951

MODEL 66951—Air chuck for inflating tires. 1/4" N.P.T. female inlet.

WATER NOZZLE



Model 846

MODEL 846—Water bibb cock for attaching to water service hose. Thumb action trigger and built-in strainer. 1/4" N.P.T. female inlet.

AIR CONTROLS



Model 600004



Model 82413



Model 600108



Model 600208

MODEL 600004—Air line regulator, 1/4" NPTF (F). Maximum pressure 300 psi.

MODEL 82413—Air control assembly. Includes model 66100 air gauge and model 600004 air regulator. Inlet and outlet 1/4" NPT female.

MODEL 600108—Die-cast zinc filter with 40 micron filter element of porous bronze and metal bowl with sight glass. Maximum supply pressure 175 psi. Inlet and outlet 1/2" NPTF (F).

MODEL 600208—Die-cast zinc lubricator with metal bowl with sight glass. Maximum supply pressure 175 psi. Inlet and outlet 1/2" NPTF (F).

AIR BLOW GUNS



Model 960

Model 950

MODEL 950—Handy, thumb-button design air blow gun. 1/2" NPT female. Equipped with pressure restrictor. Meets all Federal Safety Regulations.

MODEL 840—Same as Model 950, less air restrictor.

MODEL 960—Similar to Model 950, except has cast aluminum pistol grip design. Overall height 5 3/4". Inlet 1/4" NPT.

MODEL 940—Same as Model 960, less air restrictor.

AIR COUPLERS & NIPPLES

Heavy Duty



Model 815



Model 11659



Model 11661

MODEL 815—Coupler with 1/4" NPT female inlet. Furnished as standard equipment on all Lincoln Series 20 air motor operated Lubriguns. Maximum air flow 52 SCFM at 100 psi. Length 2 1/4"; diameter 1 1/8"; weight 4 1/2 ozs.

MODEL 11659—Nipple—1/4" NPT male.

MODEL 11661—Nipple—1/4" NPT female.

Lightweight



Model 5862



Model 13329



Model 13331

MODEL 5862—Air coupler with 1/4" NPT female inlet. Interchangeable with Aro 210 and Milton 775. Maximum air flow 48 SCFM at 100 psi. Length 1 1/8"; diameter 1 1/8"; weight 3 1/2 ozs.

MODEL 13329—Nipple—1/4" NPT male.

MODEL 13331—Nipple—1/4" NPT female.

HIGH PRESSURE LUBRIGUNS



Model 917



Model 346P



Model 989

LINCOLN LUBRICATING EQUIPMENT

CONTROL VALVES & SWIVELS



MODEL 740—Standard high pressure control valve for use with Lincoln standard high pressure swivels. Includes 6" extension tube with a 5845 hydraulic coupler.

MODEL 780—Volume shut-off valve for use with fluid lubricants. Includes 82067 shut-off valve with built-in swivel and No. 82070 non-drip swivel nozzle extension.

MODEL 81387—Universal high pressure swivel. 1/2" 27 male x 1/4" NPT male.

REPLACEMENT METERS

Max. Working Pressure—1000 psi



MODEL 877—Motor oil/anti-freeze metering control valve. 16 quart totalizing with 1/4 quart graduation, non-drip nozzle, a 10" hose extension and 1/2" N.P.T. female inlet & outlet.

MODEL 878—Gear lube metering control valve. 8 pint totalizing with 1/4 pint graduation, non-drip nozzle, a rigid extension and 1/2" N.P.T. female inlet & outlet.

REPLACEMENT COUPLERS



Model 5845

MODEL 5852—Small diameter coupler for use with hand guns only.

MODEL 5845—For contacting hydraulic fittings. Reversible coupler jaws double service life.

MODEL 5848—360° coupler adapter. Swivels in a full circle.

EXTENSION ADAPTERS



MODEL 5803—Needle nozzle for contacting flush type fittings or hard to reach hydraulic type fittings.

MODEL 5855—Extension adapter for lubricating recessed fittings.

MODEL 5859—Angle lube adapter. Allows for fast and complete lubrication of front wheel drive cars.

MODEL 83278—For lubricating U-joints and spindles. Includes 34385 rubber tip and 81980 locking sleeve.

MODEL 82784—For contacting hard to reach and flush type fittings. Includes 5803 needle nozzle and 81980 locking sleeve.

NOZZLE EXTENSIONS



MODEL 5812—12" whip hose extension for use with hand and power operated grease guns.

MODEL 5818—18" whip hose extension for use with hand or power operated grease guns. 1/8" N.P.T. male both ends.

MODEL 71512—12" whip hose extension for hand operated grease guns only. 1/8" NPT male both ends.

MODEL 71518—18" whip hose extension for hand operated grease guns only. 1/8" NPT male both ends.

MODEL 5858—Flexible or rigid adapter has overall length of 13", features metal sleeve lock action and 5852 hydraulic coupler. Threaded 1/4" NPT.

GREASE FITTINGS



Lincoln grease fittings are available in attractive blister packed cards of 5, 10, 24 and 30 fittings each and in bulk quantities of 100 and 1,000. Assortment of 100 in six of the most popular thread sizes is also available.

5000 —1/8" pipe th'd straight

5010 —1/4"-28 straight, short th'd

5013 —1/4"-28 straight, long th'd

5050* —1/4" pipe th'd straight

5100* —1/8" pipe th'd with 30° angle

5200 —1/8" pipe th'd with 45° angle

5210 —1/4"-28 short th'd with 45° angle

5300* —1/8" pipe th'd with 65° angle

5400 —1/8" pipe th'd with 90° angle

5410 —1/4"-28 short th'd with 90° angle

*Not available in blister-pack cards.

NO. 66953—easy-out tool for tapping 1/4"-28 threads and removal of both 3/8" and 1/2" hex, straight or angle fittings.

NO. 90776—Easy-out tool for tapping 1/8" N.P.T. threads and removal of 3/16" hex, straight or angle fittings.

GREASE FITTING ASSORTMENTS



MODEL 5469—Dispenser assortment contains 100 assorted grease fittings in six popular sizes. Packed in a transparent plastic box.

MODEL 5470—Economy pack contains 24 assorted grease fittings in six sizes.

MODEL 5468—Mini pack contains 10 assorted fittings. Blister packed on one card.

MODEL 5186—Deluxe assortment contains 100 assorted metric fittings in all sizes. Packed in a transparent, plastic box.

MODEL 5185—Economy pack contains 30 fittings in three 6mm metric sizes.

MODEL 5184—Mini pack contains an assortment of three 6mm sizes.

12 Volt Industry Standard DC Fuel Transfer Pumps

- 12' Hose
- Manual nozzle
- Explosion-proof UL/cUL listed 1/4-HP motor, ball bearing construction
- Corrosion-proof adjustable section pipe
- 2" threaded base for tank openings
- Thermal overload protection
- Rain proof
- Pump may be padlocked



FIL-FR1210C
15 GPM (57 LPM)



FIL-FR4210D
20 GPM (76 LPM)

FIL-FR2404 **24 Volt DC Heavy Duty Pump, Up To 15 GPM (57 LPM)**

- 1/4 HP explosion-proof motor with 2 sealed ball bearings
- 1" NPT inlet, 1" NPT outlet
- 2" NPT thread tank adapter



FIL-FR4204 **12 Volt DC Heavy Duty High Flow Pump, Up To 20 GPM (76 LPM)**

- 1/4 HP explosion-proof motor with 2 sealed ball bearings
- 1" NPT inlet, 1" NPT outlet
- 2" NPT thread tank adapter



FIL-FR604 **115 Volt AC Heavy Duty Pump, Up To 15 GPM (57 LPM)**

- 1/4 HP explosion-proof motor with 2 sealed ball bearings
- 1" NPT inlet, 3/4" NPT outlet
- 2" NPT thread tank adapter



Lube Transfer Cast Iron Pumps

- Weather resistant electric motor driven gerotor gear pump
- Self priming, positive displacement design
- Tank or side mount
- Necessary power to pump viscous fluids
- Kit comes complete with suction pipe, 3/4" x 8 ft. hose, nozzle, and quick-detach adapter
- Can be used to transfer used oil



FIL-LP50P18Q115
4.5 GPM (17 LPM), 115 Volt AC

- 1/3 HP • 50 PSI
- Maximum current: 5.2 Amps
- Power cord: 36" 3 prong
- Pump inlet/outlet size: 1" NPT — 3/4" NPT

FIL-LP50P18Q12
4.5 GPM (17 LPM), 12 Volt DC

- 1/2 HP
- 50 PSI
- Maximum current: 39 Amps
- Pump inlet/outlet size: 1" NPT — 3/4" NPT

FIL-FR112 **Rotary Hand Pump with 8' Hose**

- Effective with medium viscosity liquids, as well as oils, gasoline and diesel fuels
- Transfer at up to 10 GPM (38 LPM) per 100 revolutions
- Built-in check valve and strainer
- UL Listed



FIL-FR152 **Piston Hand Pump with 8' Hose**

- This compact, high flow, dual action design delivers up to 20 GPM (76 LPM) per 100 strokes
- Pump flow can be reversed by rotating piston 180°
- UL Listed



FIL-FR807CL **Basic Flow Meter with 3/4" Inlet & Outlet**

- Mechanical flow meters designed for metering diesel fuel, gasoline, kerosene, mineral spirits, stoddard solvent and heptane
- Operates at 5 to 20 GPM, accurate to +/- 1%.



CIT-C530 **Fuel Transfer Tank**

- Two way rotary pump for siphoning or dispensing. Works great for repairing "in-tank" fuel pumps.
- Two wheel dolly design
 - 42" H x 20" W x 22" D
 - 30 gallon capacity
 - Meets OSHA and FM standards
 - Flame arrester neck - 2" filler
 - 8' clear vinyl hose - 1/2" OD.
 - Ground wire and clamp
 - 14 gauge welded steel
 - Shipping weight 85 lbs.
 - 90 days warranty from date of purchase
 - Shown with optional C536 filter.



CIT-C20 **20 Gallon Parts Cleaner**

- Rugged welded steel
- Removable work shelf
- Parts basket for shaking small parts in solvent
- Self-latching fuse linked fire cover
- 110 Volts/60 cycle solvent pump
- Recirculates 10-12 litre/minute of solvent
- Solvent cap.: 12 Gallons
- ULC/CSA approved



CIT-C216 **16 Gallon Parts Washer**

- Capacity of 8-14 gallon solvent
- Tank: 21" W x 31" L x 9" D
- 110V pump
- CSA approved



CIT-C230 **30 Gallon Parts Washer**

- Capacity of 17-28 gallon solvent
- Tank: 27" W x 35" L x 9" D
- 110V pump
- CSA approved

Steel Hand & Appliance Trucks

Steel Hand Trucks

- 1"x16 ga. welded steel tubing
- Roller-bearing wheels
- 8x14" noseplate
- 600 lb. capacity

Key	Wheels	WxH
A	10x3" pneu.	21x47"
B	10x3" pneu.	21x47"
C	10x3" pneu.	21x51"
D	8x2" semi	18x47"
E	8x2" semi	18x50"

2-In-1 Convertible Steel Hand Trucks

- Converts in seconds to platform truck
- Includes 2 swivel casters
- Ball bearing wheels
- 1"x15 ga. steel tube construction

Wheel Size/Type	Lbs. Capacity	
	Vert.	Horiz.
8x1½" semi	300	400
10x2½" semi	400	500
10x3½" pneum.	500	600

Appliance Hand Trucks

- Belt secures appliance to truck
- 8x2" semi-pneumatic wheels
- 24"Wx60"H
- 800 lb. capacity
- 5x24" noseplate

Key	Belt
F	Standard
G	Ratchet

DRUM HANDLING EQUIPMENT



125

127

920

DRUM HAND TRUCKS

- For carrying 45-gallon barrels and drums upright
- Manoeuvre in tight areas where powered forklifts cannot operate
- Safety chime drum hook slides along central vertical bar to adjust to drum height—holds drum securely
- Double forks and widespread handlebars for leverage and handling ease
- All-welded tubular steel frame with plastic handgrips and puncture-proof, moldon rubber wheels
- Model 920 is equipped with 6" rear wheels to facilitate travel on uneven surfaces as well as the loading of drums onto pallets

Model	Dimensions	Capacity	Wheels	Weight
125		1000 lb.	10 x 2"	70 lb.
127	60 x 24"	1200 lb.	10 x 2 1/2"	73 lb.
920		1000 lb.	10 x 2 1/2"	70 lb.



DRUM DOLLY 40

- Handles 45 gallon drums
- All-welded steel construction
- Dimensions: 24" diameter
- Casters: 3 x 1 1/8"

Model	Capacity	Weight
40	900 lb	22 lb



DRUM DOLLY 950

Move full, open 45 gallon drums without spilling. Low level frame allows easy loading of drums. Truck can be pushed or pulled by moving the hinged handle forward or backward. All welded steel construction. Rolls smoothly on two 8" rubber casters and one 5" swivel rubber caster. 1000 lb. capacity.

Item	Model	Capacity	Weight
520092	950	1000 lb	35 lb



925



926

Model 925

- Ideal for storing and draining; without casters

Model 926

- Ideal for moving and draining; with 4 rigid casters

DRUM CRADLES—900 Series

- One man can load and unload drums easily, safely and quickly
- Ideal for moving, draining or storing 45 gallon drums
- All welded construction
- To put the barrel in horizontal position, simply set barrel against cradle, engage the hook of the sliding loading bar on the top rim of drum, then pull on the handle—toes of the cradle will automatically go under the drum

Model	Capacity	Weight
925		30 lb.
926	1000 lb.	35 lb.



DRUM FAUCETS



MOLASS GATE VALVES
2" - 3"



DRUM DEHEADER



DRUM PLUG WRENCH

ENGINE CRANES



JET PORTABLE SHOP CRANES AND ENGINE HOISTS

- * Ruggedly constructed telescoping boom and legs give added stability and maneuverability.
- * Heavy duty hydraulic cylinder has a built in overload device.
- * Comes complete and ready to use.
- * Hooks and 3/8" x 17" chain extension is included

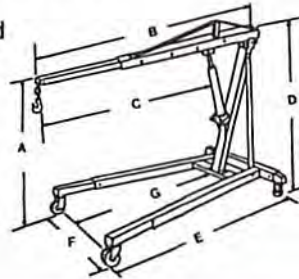

SPECIFICATIONS:

MODEL NUMBER	PRODUCT NUMBER	BOOM POSITION	CAPACITY LBS	A MAX	A MIN	B	C	D	E MAX	F MAX	G MAX	WHEEL DIA.	WEIGHT LBS
SH4000	191012	1	4000	88-5/8"	31"	53-3/16"	33"	60"	92"	37"	73-1/2"	3-1/2"	286
		2	3000	93-3/4"	26"	62-3/16"	42"						
		3	2000	98-7/8"	20-3/4"	71-3/16"	51"						
		4	1000	103-3/4"	16"	80-3/4"	60"						



PALLET PULLER

- Double-scissor design tightens as you pull
- 2 1/4" high grabbing surfaces for stringers up to 4 1/2" thick
- Comes with 32" long pull chain
- Weigh only 19 lb.

Dimensions	Capacity
12 x 16"	1250 lb.

JACKALL JACK

48" CAP.
8000 LBS.



HYDRAULIC HAND PALLET TRUCK

JET HYDRAULIC HAND PALLET TRUCK

- * High quality 5,500 lb. capacity.
- * Lowered height of 2-7/8" for smaller pallet openings.
- * Touch-control neutral lever.
- * Polyurethane enamel coating for a durable finish.
- * Automatic-return handle assumes upright position when work is done.
- * Unique oil pressure pump, with load limiter.
- * "D" handle operated from the side as well as from standard rear position.
- * Polyurethane rubber covered steel wheels with ball bearings.
- * Wide, easily maneuvered steer wheels.
- * Solid steel lifting rods.
- * Zerk grease fittings for easy lubrication.

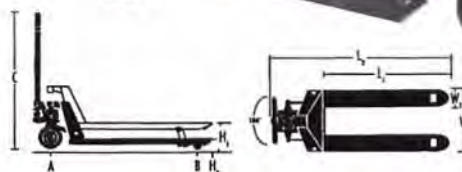

SPECIFICATIONS:

MODEL NUMBER	PRODUCT NUMBER	RATED CAPACITY (LBS.)								SHIP WEIGHT LBS.
W1	W2	L1	L2	H1	H2	A	B			
PT-2748J	190917	5,500								195
27"	6"	48"	63"	6-1/4"	2-1/2"	6-1/4" x 2-3/4"	2-1/2" x 4"			

HYDRAULIC BOTTLE JACKS



JET INDUSTRIAL BOTTLE JACKS

- * These well-established JET industrial hydraulic bottle jacks have earned a reputation for extra heavy duty performance, reliability and dependability.
- * Tested to over 150% of rated capacities.
- * Electrically welded base and cylinder assures strength and eliminates leaks.
- * Rigidly adheres to JIS standards.
- * Available in standard and low profile models.
- * Not affected by temperature extremes.
- * All models work in upright, angle or horizontal positions.
- * Equipped with convenient extension screw for low pick up height adjustment.
- * Cleated steel lift saddle for safest operator conditions.
- * Fully serviceable; common release valve assemblies and other interchangeable parts allow quick repairs.



SPECIFICATIONS: Standard Models

MODEL NUMBER	PRODUCT NUMBER	RATED CAPACITY	CLOSED HEIGHT	PISTON HEIGHT	HEAD SCREW HEIGHT	MAXIMUM HEIGHT	BASE SIZE	HANDLE TYPE	WEIGHT (LBS.)
JHJ-2	140101	2 ton	7-1/8"	4-1/2"	2"	13-9/16"	4-5/16"x2-9/16"	2 piece	6
JHJ-3	140102	3 ton	7-1/2"	4-1/2"	2-3/8"	14-3/8"	4-1/2"x2-13/16"	2 piece	6
JHJ-5	140103	5 ton	7-7/8"	4-3/4"	2-3/4"	15-3/8"	5-3/16"x15/16"	3 piece	8
JHJ-8	140104	8 ton	7-7/8"	4-3/4"	2-3/4"	15-3/8"	6"x3-1/2"	3 piece	12
JHJ-12-1/2	140105	12-1/2 ton	9-1/2"	5-7/8"	3-1/8"	18-1/2"	6-1/2"x4-3/16"	3 piece	18
JHJ-17-1/2	140107	17-1/2 ton	10-7/16"	6-1/2"	3-1/8"	20-1/16"	7-1/8"x4-5/8"	3 piece	23
JHJ-22-1/2	140109	22-1/2 ton	10-5/8"	6-1/4"	--	16-5/16"	7-3/16"x5-1/16"	3 piece	27
JHJ-35	140111	35 ton	11"	6-1/4"	--	17-5/16"	7-9/16"x5-9/16"	1 piece	41
JHJ-60	140112	60 ton	12"	6-3/4"	--	18-11/16"	9-5/16"x7-3/8"	1 piece	82

SPECIFICATIONS: Low Profile Models

MODEL NUMBER	PRODUCT NUMBER	RATED CAPACITY	CLOSED HEIGHT	PISTON HEIGHT	HEAD SCREW HEIGHT	MAXIMUM HEIGHT	BASE SIZE	HANDLE TYPE	WEIGHT (LBS.)
JHJ-12-1/2LP	140106	12-1/2 ton	6-3/4"	3-3/4"	3"	13-3/8"	6-1/2"x4-3/16"	1 piece	14
JHJ-17-1/2LP	140108	17-1/2 ton	6-3/4"	3-1/2"	2-3/4"	13"	7-1/8"x4-5/8"	1 piece	18
JHJ-22-1/2LP	140110	22-1/2 ton	7-1/8"	3-3/8"	1-9/16"	12"	7-3/16"x5-1/16"	1 piece	22

JET BOAT WINCHES

- * Winches are coated with "Posi-Glaze", an oven cured epoxy providing exceptional resistance to rust, salt and chemical corrosion.
- * One piece pinion gear and shaft design eliminates gear to shaft bonding failures.
- * Oil impregnated bearings ensure smooth operation.
- * High tensile alloy steel is used for all shafts and gears.
- * Frames are embossed for extra strength.



SPECIFICATIONS:

MODEL NUMBER	PRODUCT NUMBER	LOAD CAPACITY	GEAR RATIO	HUB DIAMETER	REEL CAPACITY - ROPE				REEL CAPACITY - CABLE	
					5/16"	3/8"	7/16"	1/2"	1/8"	3/16"
GPW1200	113106	1200	4.2:1	3/4"	50'	25'	20'	-----	200'	90'
GPW2500	113107	2500	5.1:1/12.2:1	1"	-----	50'	35'	30'	-----	170'

MECHANICAL JACKS

THE SIMPLEX PLUS

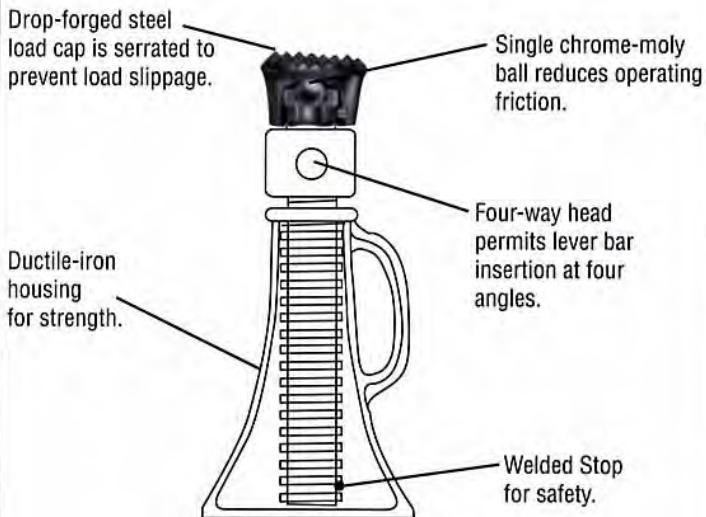
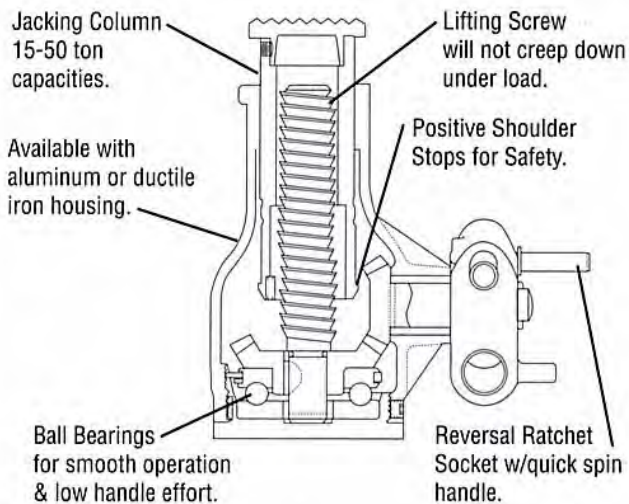
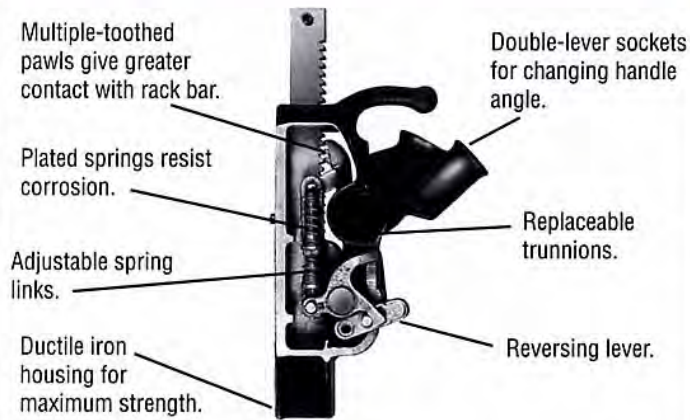

SIMPLEX MECHANICAL JACKS



RATCHET JACKS



SUPERJACKS®



SCREW JACKS

PUMP AND CYLINDER SETS



Simplex Pump & Cylinder Sets Provide Pre-Matched Hand Pump, Hose & Cylinder For Ordering Convenience.

BENEFITS/FEATURES

Eliminate the hassle of matching the right hand pump to the right cylinder by ordering Simplex pre-matched pump & cylinder sets. All hand pumps have been carefully chosen to provide maximum efficiency and service, and each set comes with a 6' hose equipped with a high flow coupler. For more information on hand pump performances & cylinder speeds, see page 29.

- Maximum versatility/wide choice of cylinders.
- Maximum performance with matched cylinders.
- Use upright, inverted or horizontally.
- Maximum control & safety.
- Control the cylinder away from the lift.
- Available with single speed or two speed pump.



Flat Jacks & Low Profile Sets

Model Single Speed Pump	Model Two Speed Pump	Cap. (tons)	Stroke (in)	Closed Height (in)	Included In Set				Optional Gauge	Optional Gauge Adapter
					Cylinder Model	Pump Model Single Speed	Pump Model Two Speed	Type Of Hose		
S101	ST101	10	7/16	1 11/16	RFS10	P41	P42	HC6	GT10	GA1
S201	ST201	20	1 1/2	3 15/32	RLS201					
S302	ST302	30	2 7/16	4 5/8	RLS302					
S502	ST502	50	2 3/8	4 13/16	RLS502					
S1002	ST1002	100	2 1/4	5 9/16	RLS1002					

Standard Spring Return Sets

S102	ST102	10	2 1/8	4 25/32	R102	P41	P42	HC6	GT10	GA1
S106	ST106	10	6 1/8	9 3/4	R106					
S1010	ST1010	10	10 1/8	13 3/4	R1010					
S252	ST252	25	2	6 1/2	R252					
S254	ST254	25	4	8 1/2	R254					
S256	ST256	25	6 1/4	10 3/4	R256	P41	P140	HC6	GT25	GA1
N/A	ST2514	25	14 1/4	18 3/4	R2514	N/A				
N/A	ST556	55	6 1/4	11 1/8	R556				GT50	

Hard-Kor™ Sets

S302HC	ST302HC	30	2	5	RC302	P41	P42	HC6	GT30	GA1
S306HC	ST306HC	30	6	9 3/4	RC306	P70	P42			

Gat'r Jaw Sets

SS2000	SST2000	1	4	1/2	S2000	P41	P42	HC6	G5	GA1
SS3000	SST3000	1.5	9	3/4	S3000					

Light weight Aluminum Sets

N/A	ST508	50	8	14 23/32	RAS508	N/A	P140	HC6	G5	GA1
-----	-------	----	---	----------	--------	-----	------	-----	----	-----

MANUAL ADJUSTABLE TROLLEYS



JET SBT SERIES BALL BEARING TROLLEYS

- * New SBT series features double sealed ball bearings.
- * Use on straight or curved track.
- * Safety lugs provide insurance against falling.
- * Can be installed or removed at any point along the track.
- * Adjustable to fit various sizes of flange and I-beams.
- * Built-in bumper guards.
- * Can be used with H and I-beams.
- * Meets ANSI and EEC specifications.

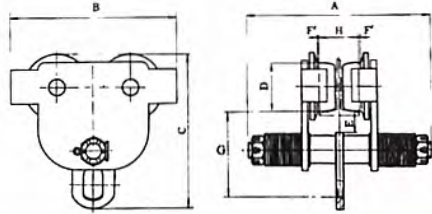

SPECIFICATIONS:

PRODUCT NUMBER	CAP'Y (LBS.)	I-BEAM FLANGE WIDTH	MIN. RADIUS CURVE	NET WEIGHT (LBS.)	DIMENSIONS IN INCHES								
					A	B	C	D	E	F	G	H Min	H Max
120251	1100	3-1/4"-5-1/2"	36"	16	10-1/4	8-1/2	8-1/8	2-1/4	1-1/4	1/8	4-41/64	3-1/4	5-1/2
120252	2200	4"-5-1/2"	40"	28	10-3/4	10-1/4	9-3/8	2-15/16	1-1/4	1/8	5-13/64	4	5-1/2
120253	3300	4"-5-1/2"	40"	42	11-1/4	10-3/4	10	3-3/8	1-1/8	1/8	5-1/4	4	5-1/2
120254	4400	4"-6"	43"	46	13-5/8	11-7/8	10-15/16	3-1/2	1-1/8	1/8	6-1/16	4	6
120255	6600	4"-6"	51"	77	14-3/8	13-1/2	13-15/16	4-5/16	13/16	1/8	7-21/32	4	6
120256	11000	4-1/4"-8-1/32"	55"	110	15-1/8	15-3/8	15-29/32	4-3/4	13/16	1/8	8-3/4	4-1/4	8-1/32
120257	22000	4-5/8"-8-1/32"	67"	196	15-15/16	18-1/2	19-5/8	5-29/32	1-3/4	1/8	11	4-5/8	8-1/32

PLATE CLAMPS



JET VA SERIES (VERTICAL TYPE)

- * VA series clamps are vertical type with safety lock.
- * Suitable for lifting and inverting loads.
- * Cam and jaws feature wear limit signal trends, punch marks to detect overload, checking zone for work insertion.

MODEL NUMBER	PRODUCT NUMBER	WEIGHT CAPACITY	THICKNESS CAPACITY	NET WEIGHT (LBS.)
VA-050	109201	1/2 ton	0-7/8"	6.8
VA-100	109202	1 ton	0-63/64"	11.7
VA-200	109204	2 ton	0-1-13/32"	18
VA-300	109205	3 ton	0-1-9/16"	30
VA-500	109206	5 ton	0-1-63/64"	46



JET DRUM LIFTER

- * Compact and lightweight.
- * Will lift drums with or without lids.
- * Easy to attach and detach.
- * Spring loaded cam insures secure grip under load or no load conditions.

MODEL NUMBER	PRODUCT NUMBER	WEIGHT CAPACITY	NET WEIGHT (LBS.)
DL-100	109242	1 ton	7.9

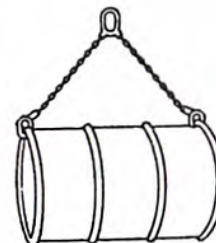

HOISTS

VGD VLH Type 1 Lever Hoists

Hoist No.	Tonnage Rating	Lift	Capacity (lbs)	Load Chain	Weight (lbs)	Vanguard Code
VLH 12	1/2	w/o	1,000	5x12	7.00	3855 0005
VLH 12x5	1/2	5	1,000	5x15	8.80	3855 0505
VLH 12x10	1/2	10	1,000	5x15	10.60	3855 1005
VLH 34	3/4	w/o	1,500	6x18	13.20	3855 0007
VLH 34x5	3/4	5	1,500	6x18	15.90	3855 0507
VLH 34x10	3/4	10	1,500	6x18	18.50	3855 1007
VLH 34x15	3/4	15	1,500	6x18	21.20	3855 1507
VLH 34x20	3/4	20	1,500	6x18	23.80	3855 2007
VLH 112	1 1/2	w/o	3,000	8x24	19.20	3855 0015
VLH 112x5	1 1/2	5	3,000	8x24	24.70	3855 0515
VLH 112x10	1 1/2	10	3,000	8x24	29.50	3855 1015
VLH 112x15	1 1/2	15	3,000	8x24	34.20	3855 1515
VLH 112x20	1 1/2	20	3,000	8x24	39.00	3855 2015
VLH 3	3	w/o	6,000	10x30	37.50	3855 0030
VLH 3x5	3	5	6,000	10x30	46.30	3855 0530
VLH 3x10	3	10	6,000	10x30	53.60	3855 1030
VLH 3x15	3	15	6,000	10x30	60.90	3855 1530
VLH 3x20	3	20	6,000	10x30	68.40	3855 2030
VLH 6	6	w/o	12,000	10x30	50.70	3855 0060
VLH 6x5	6	5	12,000	10x30	68.40	3855 0560
VLH 6x10	6	10	12,000	10x30	82.90	3855 1060
VLH 6x15	6	15	12,000	10x30	97.50	3855 1560
VLH 6x20	6	20	12,000	10x30	111.80	3855 2060

Lever hoist with overload protection and/or custom lengths available upon request



VGD VCH Type 1 Chain Hoists

Hoist No.	Tonnage Rating	Lift	Capacity (lbs)	Load Chain	Weight (lbs)	Vanguard Code
VCH 12	1/2	W/O	1,000	6x18	13.2	3850 0005
VCH 12x10	1/2	10	1,000	6x18	24.3	3850 1005
VCH 12x20	1/2	20	1,000	6x18	35.3	3850 2005
VCH 1	1	W/O	2,000	6x18	17.6	3850 0010
VCH 1x10	1	10	2,000	6x18	28.7	3850 1010
VCH 1x20	1	20	2,000	6x18	39.7	3850 2010
VCH 112	1 1/2	W/O	3,000	8x24	22.1	3850 0015
VCH 112x10	1 1/2	10	3,000	8x24	36.4	3850 1015
VCH 112x20	1 1/2	20	3,000	8x24	50.7	3850 2015
VCH 2	2	W/O	4,000	8x24	28.7	3850 0020
VCH 2x10	2	10	4,000	8x24	44.1	3850 1020
VCH 2x20	2	20	4,000	8x24	59.1	3850 2020
VCH 3	3	W/O	6,000	8x24	35.3	3850 0030
VCH 3x10	3	10	6,000	8x24	59.5	3850 1030
VCH 3x20	3	20	6,000	8x24	83.8	3850 2030
VCH 5	5	W/O	10,000	10x30	62.8	3850 0050
VCH 5x10	5	10	10,000	10x30	100.3	3850 1050
VCH 5x20	5	20	10,000	10x30	134.9	3850 2050

... Chain hoists with overload protection and/or custom lengths available upon request

... 10T and 20T chain hoists are also available as a special order from our factory



KITO L4LB SERIES LEVER CHAIN HOISTS

3/4 to 9 metric tonne capacity, tough, smooth-operating lever hoists for industrial and commercial use

KITO L4 Series Lever Hoists are built with premium-grade components for long life in demanding industrial and contracting applications. L4 lever hoists feature double-reduction gearing for reduced size and weight, steel housings for durability, and industry-leading quality.

Features

- At rated capacity, load-bearing parts are only stressed to 25% of their limit
- Abrasion resistant, case-hardened load chain is made from heat-treated alloy steel for high, uniform strength
- Forged carbon steel hook design will not fracture under excessive load
- Safe, reliable mechanical brake activates instantly, holds the load securely
- Double reduction gearing requires minimum manual power to operate
- Spring-loaded freewheel for fast, easy load chain freewheeling
- Open load sheave allows easy inspection and cleaning without dismantling the unit
- 360° handle rotation for a sure grip from any operating position
- Compact design for lightweight portability
- Five-start thread on brake ensures a level braking surface to ease load break-out
- Articulating top hook allows you to properly centre the load
- High-impact steel housing with similar weight to aluminum due to compact design
- Sealed gears and brake protected against damage from dust and water



Specifications

Model	Max. Capacity (tonne)	Std. Lift (ft)	Hand Pull to Lift Full Load (kg)	Ship Weight (lbs)	Load Chain Code	Load Chain Falls	Weight per Additional 5 ft of Lift (lbs)
L4LB008	0.75	5	29	15	KLB4056	1	3
L4LB015	1.5	5	29	22	KCF071	1	4
L4LB030	3	5	35	36	KCB3090	1	6
L4LB060	6	5	36	62	KCB3090	2	11
L4LB090	9	5	37	97	KCB3090	3	17

KITO CF SERIES MANUAL CHAIN HOISTS

1/2 to 5 metric tonne capacity, economical, smooth-running hoists for shop and light industrial use

KITO CF Series Manual Chain Hoists are built with quality components to provide years of reliable service. CF manual chain hoists feature heat-treated components, sealed bearings, and industry-leading quality.

Features

- At rated capacity, load-bearing parts are only stressed to 25% of their limit
- Abrasion resistant, case-hardened load chain is made from heat-treated alloy steel for high, uniform strength
- Forged carbon steel hook design will not fracture under excessive load
- Safe, reliable mechanical brake activates instantly, holds the load securely
- Compact design for lightweight portability
- Articulating top hook allows you to properly centre the load
- Sealed gears and brake protected against damage from dust and water
- Maintenance-free sealed bearings increase reliability and reduce the pull required to lift loads
- Heat treated load bearing parts are hardened for long, trouble-free life
- Die cast aluminum housing for lightweight portability

Specifications

Model	Max. Capacity (tonne)	Std. Lift (ft)	Hand Pull to Lift Full Load (kg)	Chain Pulled to Lift One Metre (m)	Ship Weight (lbs)	Load Chain Code	Load Chain Falls	Hand Chain Code	Hand Chain Falls	Weight per Additional 5 ft of Lift (lbs)
CF005	0.5	8	30	19	24	KCF050	1	KHCF050	2	5
CF010	1	8	36	31	31	KCF063	1	KHCF050	2	6
CF015	1.5	8	42	41	42	KCF071	1	KHCF050	2	7
CF020	2	10	40	63	51	KCF063	2	KHCF050	2	9
CF030	3	10	46	81	68	KCF071	2	KHCF050	2	11
CF050	5	10	46	134	88	KCF071	3	KHCF050	2	15



KITO EFS SERIES ELECTRIC CHAIN HOISTS

1/4 to 2 metric tonne capacity, single phase (115V) hoists for everyday shop use

KITO EFS Series Electric Chain Hoists are engineered for daily use in shop, farm, or light industry. EFS chain hoists feature advanced hoist technology, easy serviceability, and industry-leading quality.

Features

- Load-bearing parts are only stressed to 20% of their limit at rated capacity
- Abrasion resistant, case-hardened load chain is made from heat-treated alloy steel for high, uniform strength
- Forged carbon steel hook design will not fracture under excessive load
- Advanced fail-safe pull rotor brake is electrically activated and requires no adjustment
- Spur gears immersed in oil bath ensure quiet, smooth operation and long life
- Unique chain guide design for smooth chain travel
- Slip clutch protects the hoist against overtravel and overload damage
- 360° swivel bottom hook with built-in bearing, for easy positioning
- Weathertight construction resists dust and water
- High capacity condensers for long life



Specifications

Model	Max. Capacity (tonne)	Std. Lift (ft)	Lift Speed (ft/min)	Hoist Motor H.P.	ASME Hoist Duty Class	Max. Starts per Hour	%ED	Short Time Rating (min)	Rated Current 115V (amps)	Ship Weight (lbs)	Load Chain Code	Load Chain Falls	Max. Lift (ft)	Weight per Additional 5 ft of Lift (lbs)
EFS003S	0.25	10	16	0.53	H3	150	25	15	6.8	80	KES050	1	50	3
EFS005L	0.5	10	7	0.53	H3	150	25	15	6.8	90	KES050	2	50	5
EFS005S	0.5	10	14	0.53	H3	150	25	15	11.8	110	KES063	1	50	4
EFS010L	1	10	5	0.53	H3	150	25	15	11.8	120	KES063	2	50	7
EFS010S	1	10	9	0.73	H3	150	25	15	12.1	145	KES071	1	50	5
EFS020L	2	10	5	0.73	H3	150	25	15	12.1	155	KES071	2	50	9

KITO TF2, TS2, TMH, AND MR SERIES TROLLEYS

Industrial quality trolleys built for long life and reliable operation



Model	Max. Capacity (tonne)	Ship Wt. (lbs)	Min. Radius for Curve (mm)	Flange Width			Std Drop (ft)	Travel Speed (ft/min)	Travel Motor H.P.
				Std. (mm)	W20 Ext. (mm)	W30 Ext. (mm)			
Plain Trolley - NO Safety Lugs									
TFP2005	1/2	7	350	50 - 102	103 - 203	204 - 305	---	---	---
TFP2010	1	11	450	58 - 127	128 - 203	204 - 305	---	---	---
TFP2020	2	24	550	82 - 153	---	154 - 305	---	---	---
TFP2030	3	40	650	82 - 153	---	154 - 305	---	---	---
TFP2050	5	96	2000	125 - 178	---	179 - 305	---	---	---
Plain Trolley - WITH Safety Lugs									
TSP2005	1/2	10	1100	50 - 102	103 - 203	204 - 305	---	---	---
TSP2010	1	18	1300	58 - 127	128 - 203	204 - 305	---	---	---
TSP2020	2	31	1500	82 - 153	---	154 - 305	---	---	---
TSP2030	3	51	1700	82 - 153	---	154 - 305	---	---	---
TSP2050	5	116	2300	100 - 178	---	179 - 305	---	---	---
TSP100	10	220	3000	150 - 220	---	221 - 305	---	---	---
Motorized Trolley - Single Speed - 220V, 440V, 575V / Three Phase									
MR010L	1	68	800	58 - 127	---	128 - 305	15	40	0.5
MR010S	1	68	800	58 - 127	---	128 - 305	15	80	0.5
MR020L	2	86	800	82 - 178	---	179 - 305	15	40	0.5
MR020S	2	86	800	82 - 178	---	179 - 305	15	80	0.5
MR030L	3	106	1000	82 - 178	---	179 - 305	15	40	0.5
MR030S	3	106	1000	82 - 178	---	179 - 305	15	80	0.5
MR050L	5	152	1800	82 - 178	---	179 - 305	15	40	1
MR050S	5	152	1800	82 - 178	---	179 - 305	15	80	1
MR100L	10	238	2500	150 - 220	---	221 - 305	15	40	1
MR200L	20	499	---	150 - 220	---	221 - 305	15	40	1 x 2

GRIP PULLERS



JET WIRE ROPE PULLING HOISTS

- * May be used in any position to lift, pull, lower or stretch heavy loads.
- * Operated manually by engaging clutch and working the handle.
- * Uses standard ASA wire rope.
- * Additional wire rope may be used with pulley blocks.
- * Shear pins in the handle will break under severe overload.
- * Extra pins are provided and are easily installed.
- * Safety latches are standard.
- * Super strong, wear resistant jaws.

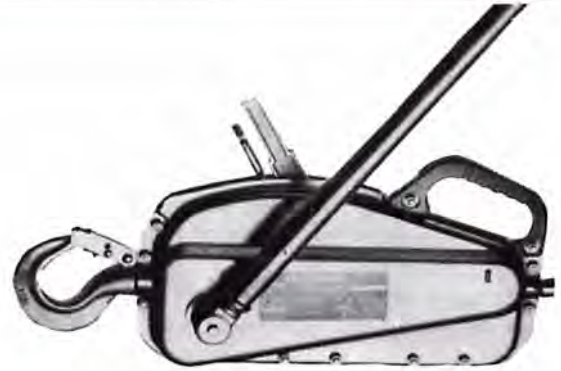

SPECIFICATIONS:

MODEL NUMBER	PRODUCT NUMBER	PULLING CAPACITY (LBS.)	LIFTING CAPACITY (LBS.)	HANDLE LENGTH	DIMENSIONS	STANDARD WIRE ROPE DIAMETER	SPEED PER MIN.	NET WT. (LBS.)	SHIP WT (LBS.)
JG-75NC	111122	2,750	1,650	29-1/2"	18-3/16"x7-5/8"x4-3/8"	5/16"	10 FPM	18	23
JG-150NC	111123	5,500	3,300	41"	23-5/8"x9-3/8"x5-5/8"	7/16"	10 FPM	40	45
JG-300NC	111124	11,000	6,600	46-1/2"	27-3/4"x9"x6"	5/8"	10 FPM	66	70

OPTIONAL ACCESSORIES FOR JET/SUMO GRIP PULLERS

- * Wire rope for JET/SUMO Series grip pullers.
- * Safety hook included.

SPECIFICATIONS:

PRODUCT NUMBER	TO FIT MODEL NUMBER	DIAMETER	LENGTH	NET WEIGHT (LBS.)
111152	JG-75/SGP-75A	5/16"	66'	15
111153	JG-150/SGP-150A	7/16"	66'	28
111154	JG-300/SGP-300	5/8"	66'	41
111162	JG-75/SGP-75A	5/16"	100'	21
111163	JG-150/SGP-150A	7/16"	100'	39
111164	JG-300/SGP-300	5/8"	100'	75



CABLE PULLERS



JET CABLE PULLERS

- * Heavy duty double pawl ratcheting system for optimum safety and efficiency.
- * 3-piece ratchet wheels are welded together to form one strong plate.
- * All steel construction.
- * Concealed spring-lever control prevents accidental release.
- * Safety latches are standard on both hooks.
- * Standard snatch block allows powerful 2 ton pulling power.



SPECIFICATIONS:

MODEL NUMBER	PRODUCT NUMBER	CAPACITY	MAXIMUM LIFT (FT)	WIRE ROPE DIAMETER	NET WEIGHT
JCP-200	111215	2 tons	12 @ 1 ton 5 @ 2 tons	3/16"	8 lbs.

CASTERS



RESILEX

Ideal for textile, laundry, hospital and food industries

Non-marking, super elastic material, shock-absorbing, silent and maintenance free. 3 year guarantee against bond failure.

Size Ø x W	Overall Height	Capacity lb.	Swivel	Item	Rigid
4 x 1 1/4"	6"	330			
5 x 1 1/4"	6 7/8"				



PROTECH 1900 SERIES

Ideal for textile, laundry, hospital and food industries

Non-marking, super shock-absorbing, silent and maintenance free.

Size Ø x W	Overall Height	Capacity lb.	Swivel	Item	Rigid
4 x 1 1/4"	5 1/4"	250			
5 x 1 1/4"	6 1/4"				



PROTECH EMAXX

Excellent for hospitals, food industry, heavy service equipment and factory use

Great for stock carts & platform trucks, garbage bins, wire shelving units. Heavy-duty 3/4" kingpin, virtually maintenance free. Wheel width: 2"

Size Ø x W	Overall Height	Capacity lb.	Swivel	Item	Rigid
4 x 2"	5 1/4"	250			
5 x 2"	6 1/4"	360			
6 x 2"	5 1/2"	450			
8 x 2"	9 1/2"	600			



GREY URETHANE

All-purpose caster

Non-marking, easy rolling, recommended for most surfaces

Size Ø x W	Overall Height	Capacity lb.	Swivel	Item	Rigid
4 x 1 1/4"	5 1/4"	250			
5 x 1 1/4"	6 1/4"				



HARD RUBBER

Light and medium duty casters

Ideal for a wide range of applications, from office to industry. Double ball bearing, self-lubricating nut and bolt axle assembly, heat-treated raceway.



Size Ø x W	Overall Height	Capacity lb.	Swivel	Item	Rigid
3 x 1 1/4"	3 13/16"	175			
4 x 1 1/4"	5"	250			
5 x 1 1/4"	6 1/16"	225			

MAXI SQUARE Scaffold

CONTRACTOR SERIES

MODEL	MAXI SQUARE SCAFFOLD		
CISC			
DIMENSIONS	HEIGHT	LENGTH	WIDTH
• Scaffold:	74" - (188 cm)	73" - (185 cm)	29" - (73.7 cm)
• Box :	5 1/2" - (14 cm)	77 1/2" - (197 cm)	30 1/2" - (77.5 cm)
COATING	Yellow thermosetting polyester finish		
• Structure :	Plywood 5/8" (1.6 cm) thick with protective steel edge banding		
• Platform (1) :			
HEIGHT INCREMENT	2" - (5 cm)		
STACKING	1 unit	6' (182 cm)	* Always use outriggers and guardrails when stacking units.
	2 units	11'6" * (353 cm)	
	3 units	17'2" * (524 cm)	
MATERIAL	Structure : Square steel tube 1 1/2" (2.5 cm ²)		
OPTIONS	CISGR	Guardrail system 35 lbs	
	CISD4	Set of 4 outriggers (with casters) 28 lbs	
	CICAS5	5" (12.7 cm) swiveling caster with locking system	
MAXIMUM LOAD	700 lbs - (317.5 kg)		
WEIGHT	146 lbs - (66.2 kg)		



Spring loaded locking mechanism

Platform locking mechanism

5" double lock casters

>> Meets CSA and OSHA standards

MINI Scaffold Step Ladder

MODEL	MINI™ SCAFFOLD STEP LADDER		UPC
IMCN			778300100200
DIMENSIONS	HEIGHT	LENGTH	WIDTH
• Scaffold :	46" - (117 cm)	39" - (99.06 cm)	21.5" - (54.61 cm)
• Box :	4" - (10.16 cm)	42" - (106.68 cm)	22.5" - (57.15 cm)
COATING	Yellow thermosetting polyester finish		
• Structure :	Yellow thermosetting polyester finish		
• Platforms (2)	Anti-slip black thermosetting polyester finish		
HEIGHT INCREMENT	12" - (30 cm)		
MATERIAL	Structure : ø 1" (2.5 cm) 16 gauge sturdy steel		Platform : 16 gauge steel
OPTIONS	IMPN	Black anti-sip platform	
	C1CAS4	4" (10 cm) Swiveling caster with locking system	
	C4CAS4	Unit	
	C4CAS4	Pack of 4 caster	
MAXIMUM LOAD	500 lbs - (226 kg)		
WEIGHT	52.8 lbs - (24		

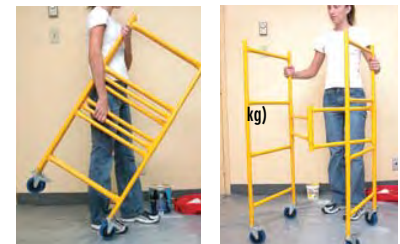

>> Meets CSA and OSHA standards



**300 lb
RATED**

6500 SERIES



EXTRA-HEAVY DUTY FIBERGLASS PLATFORM STEP

CSA Approved Grade 1, ANSI Type 1A

IDEAL FOR ALL TYPES OF FIXED HEIGHT WORK

- Durable non-conductive "C" channel side rails in high visibility safety yellow
- Large safe and comfortable standing platform, 14" x 18"
- Wide 3" slip-resistant serrated aluminum steps for safe climbing
- Rugged outside Zinc coated steel spreader arms
- Each step reinforced with Zinc coated steel diagonal braces providing strength and stiffness
- Rear horizontal struts every 22" reinforced with Zinc coated steel brace offer maximum rigidity
- Heavy-duty slip-resistant safety shoes

MODEL	SIZE	OPEN HEIGHT	VERTICAL HEIGHT TO PLATFORM	BASE WIDTH	BASE DEPTH	APPROX. WEIGHT lbs
6504	4'	46"	24"	21"	30"	17
6505	5'	57"	35"	23"	36"	22
6506	6'	68"	46"	24"	42"	25
6508	8'	90"	68"	26"	53"	33
6510	10'	113"	92"	29"	67"	41
6512	12'	135"	115"	31"	75"	50

EXTRA-HEAVY DUTY FIBERGLASS "GRATE" STEP

CSA Approved Grade 1, ANSI Type 1A

DESIGNED FOR USE ON GRATED FLOORS

- Durable non-conductive "C" channel side rails in high visibility safety yellow
- Front and rear stabilizer feet provide safe surface contact on grated floors
- Wide 3" slip-resistant serrated aluminum steps for safe climbing
- Inside spreader arms complete with "wrap-around" brackets to strengthen spreader to rail connection and protect spreader arms during storage/loading/transport
- Every other step reinforced with Zinc coated steel diagonal braces providing strength and stiffness
- Full rear "L" horizontal struts are reinforced with Zinc coated steel diagonal braces
- Stabilizers feature slip-resistant serrated rubber shoes

MODEL	SIZE	OPEN HEIGHT	HIGHEST STANDING HEIGHT	BASE WIDTH	BASE DEPTH	APPROX. WEIGHT lbs
5906	6'	68"	45"	35"	39"	27
5908	8'	90"	67"	37"	50"	35
5910	10'	113"	90"	40"	61"	44
5912	12'	137"	114"	43"	74"	59

**300 lb
RATED**

5900 SERIES



fiberglass

SUPER-HEAVY DUTY FIBERGLASS STEP

CSA Approved Grade 1, ANSI Type 1AA

THE BRUTE IS OUR STRONGEST AND MOST RUGGED LADDER, DESIGNED AND BUILT TO WITHSTAND A LIFETIME OF DEMANDING INDUSTRIAL USE.

- Extra strong non-conductive "C" channel side rails in high visibility safety yellow
- Super tough copolymer top for strength and durability
- Wide 3" slip-resistant serrated aluminum steps for safe climbing
- Inside spreader arms complete with "wrap-around" sleeves that strengthen spreader-to-rail connection and protect spreader arms during storage/loading/transit
- Each step is double braced with Zinc coated steel diagonal braces providing incredible strength and stiffness
- Full rear "L" horizontal struts reinforced with Zinc coated steel diagonal braces offer maximum rigidity
- Heavy-duty aluminum "wrap-around" sleeves at base of rails for maximum protection

MODEL	SIZE	OPEN HEIGHT	HIGHEST STANDING HEIGHT	BASE WIDTH	BASE DEPTH	APPROX. WEIGHT lbs
6804	4'	46"	23"	20"	28"	15
6805	5'	57"	34"	21"	34"	19
6806	6'	68"	45"	23"	39"	27
6807	7'	79"	56"	24"	45"	31
6808	8'	90"	67"	25"	50"	35
6810	10'	113"	90"	29"	61"	44
6812	12'	136"	113"	31"	72"	59

375 lb RATED

6800 SERIES



EXTRA-HEAVY DUTY FIBERGLASS STEP

CSA Approved Grade 1, ANSI Type 1A

CANADA'S # 1 FIBERGLASS STEP LADDER

- Durable non-conductive "C" Channel side rails in high visibility safety yellow
- Super tough copolymer top for strength and durability
- Slip-resistant serrated aluminum steps for safe climbing
- Inside spreader arms complete with "wrap-around" brackets to strengthen spreader to rail connection and protect spreader arms during storage/loading/transport
- Reinforced with Zinc coated steel diagonal braces on the front of every other step and double bracing on bottom step for added strength and stiffness
- Full rear "L" horizontal struts reinforced with Zinc coated steel diagonal braces offer maximum rigidity
- Extra-large PVC rubber safety boots are heavy-duty and provide increased rail protection and slip-resistance

MODEL	SIZE	OPEN HEIGHT	HIGHEST STANDING HEIGHT	BASE WIDTH	BASE DEPTH	APPROX. WEIGHT lbs
6402	2'	24"	11"	17"	17"	8
6403	3'	34"	11"	19"	23"	12
6404	4'	46"	23"	20"	28"	15
6405	5'	57"	34"	21"	34"	19
6406	6'	68"	45"	23"	39"	23
6407	7'	79"	56"	24"	44"	27
6408	8'	90"	67"	26"	50"	30
6410	10'	113"	90"	29"	61"	38
6412	12'	137"	114"	32"	74"	52

300 lb RATED

6400 SERIES



**300 lb
RATED**

6900 SERIES



EXTRA-HEAVY DUTY FIBERGLASS STEP

CSA Approved Grade 1, ANSI Type 1A

THE ECONOMICAL TYPE 1A ALTERNATIVE

- Durable non-conductive "C" channel side rails in high visibility safety yellow
- Super tough copolymer top for strength and durability
- Wide 3" slip-resistant serrated aluminum steps for safe climbing
- Inside spreader arms complete with "wrap-around" sleeves that strengthen spreader-to-rail connection and protect spreader arms during storage/loading/transit
- Rear horizontal struts every 22", Top and bottom struts reinforced with Zinc coated steel diagonal braces
- Reinforced with Zinc coated steel diagonal braces at top and bottom steps
- Extra-large PVC rubber safety boots are heavy-duty and provide rail protection and slip-resistance

MODEL	SIZE	OPEN HEIGHT	HIGHEST STANDING HEIGHT	BASE WIDTH	BASE DEPTH	APPROX. WEIGHT lbs
6903	3'	34"	11"	19"	23"	12
6904	4'	46"	23"	20"	28"	15
6905	5'	57"	34"	21"	34"	18
6906	6'	68"	45"	23"	39"	21
6907	7'	79"	56"	24"	44"	25
6908	8'	90"	67"	26"	51"	28
6910	10'	113"	90"	29"	61"	36
6912	12'	137"	114"	32"	74"	48

HEAVY DUTY FIBERGLASS STEP

CSA Approved Grade 1, ANSI Type 1

HIGH STRENGTH TO WEIGHT RATIO PROVIDES AN ECONOMICAL ALTERNATIVE FOR GENERAL CONTRACTOR AND DIY WORK

- Durable non-conductive "C" channel front rails in high visibility safety orange
- Super tough copolymer top for strength and durability
- Wide 3" slip-resistant serrated aluminum steps for safe climbing
- Rugged outside Zinc coated steel spreader arms
- Rear horizontal struts every 22", Top and bottom struts reinforced with Zinc coated steel diagonal braces
- Reinforced with Zinc coated steel diagonal braces at top and bottom steps
- Heavy-duty slip-resistant safety shoes

MODEL	SIZE	OPEN HEIGHT	HIGHEST STANDING HEIGHT	BASE WIDTH	BASE DEPTH	APPROX. WEIGHT lbs
6304	4'	46"	23"	20"	30"	17
6305	5'	57"	34"	21"	34"	18
6306	6'	68"	45"	23"	43"	20
6307	7'	79"	56"	24"	44"	23
6308	8'	90"	67"	26"	55"	26
6310	10'	113"	90"	29"	61"	34

**250 lb
RATED**

6300 SERIES



**300 lb
RATED**

5700 SERIES



EXTRA-HEAVY DUTY FIBERGLASS EXTENSION

CSA Approved Grade 1, ANSI Type 1A

A VARIATION OF OUR MOST POPULAR EXTENSION LADDER WITH PIVOT FEET

- Durable non-conductive fiberglass side rails in high visibility safety yellow
- Riveted rung to rail design maintains continuous strength of fibers and allows for easy repair
- Slip-resistant serrated round rungs for safe climbing
- Top cross over bar allows for ladder to be raised and lowered from front and provides torsional stiffness
- Premium heavy-duty rung locks for durability
- Large heavy-duty pivot feet with slip-resistant rubber pads and ice pick

MODEL	SIZE	MAX. OPEN LENGTH	BASE SECTION		FLY SECTION		APPROX. WEIGHT lbs
			OUTSIDE WIDTH	INSIDE WIDTH	OUTSIDE WIDTH	INSIDE WIDTH	
5716	16'	13'	17 3/8"	15"	16 5/8"	14 1/4"	38
5720	20'	17'	17 3/8"	15"	16 5/8"	14 1/4"	44
5724	24'	21'	17 3/8"	15"	16 5/8"	14 1/4"	52
5728	28'	25'	17 3/8"	15"	16 5/8"	14 1/4"	59
5732	32'	28'	17 3/8"	15"	16 5/8"	14 1/4"	66

EXTRA-HEAVY DUTY FIBERGLASS EXTENSION

CSA Approved Grade 1, ANSI Type 1A

A VARIATION OF OUR MOST POPULAR EXTENSION LADDER WITH RAISE FROM REAR PULLEY SYSTEM

- Durable non-conductive fiberglass side rails in high visibility safety yellow
- Riveted rung to rail design maintains continuous strength of fibers and allows for easy repair
- Slip-resistant serrated round rungs for safe climbing
- Traditional raise from the rear pulley design
- Premium heavy-duty rung locks
- Exclusive "1-Piece" foot assembly with spur wheel provides unequalled strength, durability and torsional stiffness

MODEL	SIZE	MAX. OPEN LENGTH	BASE SECTION		FLY SECTION		APPROX. WEIGHT lbs
			OUTSIDE WIDTH	INSIDE WIDTH	OUTSIDE WIDTH	INSIDE WIDTH	
5416	16'	13'	17 3/8"	15"	16 5/8"	14 1/4"	38
5420	20'	17'	17 3/8"	15"	16 5/8"	14 1/4"	44
5424	24'	21'	17 3/8"	15"	16 5/8"	14 1/4"	52
5428	28'	25'	17 3/8"	15"	16 5/8"	14 1/4"	59
5432	32'	28'	17 3/8"	15"	16 5/8"	14 1/4"	66

**300 lb
RATED**

5400 SERIES



9200/6200/5700/5400 OPTIONS

Cable Hooks
Part # 99063



Swivel "V" Rung
Part # 99125



Pole Strap
Part # 99061



Rigid "V" Rung
Part # 99130



Rubber End Caps
Part # 99129



FEATHERLITE
INDUSTRIAL LADDERS

fiberglass

**300 lb
RATED**

6900 SERIES



EXTRA-HEAVY DUTY FIBERGLASS EXTENSION

CSA Approved Grade 1, ANSI Type 1A

THE ECONOMICAL TYPE 1A ALTERNATIVE

- Durable non-conductive fiberglass side rails in high visibility safety yellow
- Rung through rail design
- Slip-resistant serrated "D" rungs for safe climbing and comfort
- Premium heavy-duty rung locks for durability
- Black ABS, high impact non-marring end caps
- Large heavy-duty pivot feet with slip-resistant rubber pads and ice pick

MODEL	SIZE	MAX. OPEN LENGTH	BASE SECTION		FLY SECTION		APPROX. WEIGHT lbs
			OUTSIDE WIDTH	INSIDE WIDTH	OUTSIDE WIDTH	INSIDE WIDTH	
6916	16'	13'	17"	14 5/8"	16 1/2"	14 1/4"	36
6920	20'	17'	17"	14 5/8"	16 1/2"	14 1/4"	42
6924	24'	21'	17"	14 5/8"	16 1/2"	14 1/4"	50
6928	28'	25'	17"	14 5/8"	16 1/2"	14 1/4"	56
6932	32'	28'	17"	14 5/8"	16 1/2"	14 1/4"	62

HEAVY DUTY FIBERGLASS EXTENSION

CSA Approved Grade 1, ANSI Type 1

HIGH STRENGTH TO WEIGHT RATIO PROVIDES AN ECONOMICAL ALTERNATIVE FOR GENERAL CONTRACTORS AND DIY WORK

- Durable non-conductive fiberglass side rails in high visibility safety orange
- Rung through rail design
- Slip-resistant serrated "D" rungs for safe climbing and comfort
- Premium heavy-duty rung locks for durability
- Black ABS, high impact non-marring end caps
- Large heavy-duty pivot feet with slip-resistant rubber pads and ice pick

MODEL	SIZE	MAX. OPEN LENGTH	BASE SECTION		FLY SECTION		APPROX. WEIGHT lbs
			OUTSIDE WIDTH	INSIDE WIDTH	OUTSIDE WIDTH	INSIDE WIDTH	
6316	16'	13'	17"	14 5/8"	16 1/2"	14 1/4"	31
6320	20'	17'	17"	14 5/8"	16 1/2"	14 1/4"	36
6324	24'	21'	17"	14 5/8"	16 1/2"	14 1/4"	43

**250 lb
RATED**

6300 SERIES



FEATHERLITE
INDUSTRIAL LADDERS

fiberglass

**375 lb
RATED**

9200-AA SERIES



SUPER-HEAVY DUTY FIBERGLASS EXTENSION

CSA Approved Grade 1, ANSI Type 1AA

OUR STRONGEST AND MOST RUGGED FIBERGLASS EXTENSION LADDER, DESIGNED AND BUILT TO WITHSTAND A LIFETIME OF DEMANDING INDUSTRIAL USE.

- Durable non-conductive fiberglass side rails in high visibility safety yellow
- Riveted rung to rail design maintains continuous strength of fibers and allows for easy repair
- Slip-resistant serrated "D" rungs for safe climbing and comfort
- Traditional raise from the rear pulley design
- Premium heavy-duty rung locks for durability
- Large heavy-duty pivot feet with slip-resistant rubber pads and ice pick

MODEL	SIZE	MAX. OPEN LENGTH	BASE SECTION		FLY SECTION		APPROX. WEIGHT lbs
			OUTSIDE WIDTH	INSIDE WIDTH	OUTSIDE WIDTH	INSIDE WIDTH	
9216-AA	16'	13'	17 3/8"	15"	16 5/8"	14 1/4"	40
9220-AA	20'	17'	17 3/8"	15"	16 5/8"	14 1/4"	47
9224-AA	24'	21'	17 3/8"	15"	16 5/8"	14 1/4"	56
9228-AA	28'	25'	17 3/8"	15"	16 5/8"	14 1/4"	64
9232-AA	32'	28'	17 3/8"	15"	16 5/8"	14 1/4"	72

EXTRA-HEAVY DUTY FIBERGLASS EXTENSION

CSA Approved Grade 1, ANSI Type 1A

THE #1 CHOICE OF CONTRACTORS ACROSS THE COUNTRY

- Durable non-conductive fiberglass side rails in high visibility safety yellow
- Riveted rung to rail design maintains continuous strength of fibers and allows for easy repair
- Slip-resistant serrated rungs for safe climbing (available in round or "D" profile)
- Top cross over bar allows for ladder to be raised or lowered from front and provides torsional stiffness
- Premium heavy-duty rung locks for durability
- Exclusive "1-Piece" foot assembly with spur wheel provides unequalled strength, durability and torsion resistance.

	MODEL	SIZE	MAX. OPEN LENGTH	BASE SECTION		FLY SECTION		APPROX. WEIGHT lbs
				OUTSIDE WIDTH	INSIDE WIDTH	OUTSIDE WIDTH	INSIDE WIDTH	
ROUND RUNG	6216	16'	13'	17 3/8"	15"	16 5/8"	14 1/4"	38
	6220	20'	17'	17 3/8"	15"	16 5/8"	14 1/4"	44
	6222	22'	19'	17 3/8"	15"	16 5/8"	14 1/4"	48
	6224	24'	21'	17 3/8"	15"	16 5/8"	14 1/4"	52
	6228	28'	25'	17 3/8"	15"	16 5/8"	14 1/4"	59
	6232	32'	28'	17 3/8"	15"	16 5/8"	14 1/4"	66
"D" RUNG	6216D	16'	13'	17 3/8"	15"	16 5/8"	14 1/4"	39
	6220D	20'	17'	17 3/8"	15"	16 5/8"	14 1/4"	46
	6222D	22'	19'	17 3/8"	15"	16 5/8"	14 1/4"	50
	6224D	24'	21'	17 3/8"	15"	16 5/8"	14 1/4"	55
	6228D	28'	25'	17 3/8"	15"	16 5/8"	14 1/4"	63
	6232D	32'	28'	17 3/8"	15"	16 5/8"	14 1/4"	70
	*6236D	36'	32'	19"	15 1/2"	17 3/4"	14 1/4"	96
	*6240D	40'	35'	19"	15 1/2"	17 3/4"	14 1/4"	106

* Traditional raise from the rear pulley system

**300 lb
RATED**

6200 SERIES



9200/6200/5700/5400 OPTIONS



FEATHERLITE
INDUSTRIAL LADDERS

aluminum

**300 lb
RATED**

4400 SERIES



EXTRA-HEAVY DUTY ALUMINUM STEP

CSA Approved Grade 1, ANSI Type 1A

BUILT TO LAST IN ANY INDUSTRIAL APPLICATION

- Super tough copolymer top for strength and durability
- Extra-wide 3 1/2" slip-resistant serrated aluminum steps for safe climbing
- Solid triangular braces on steps and rear horizontal struts provide unequalled rigidity
- Rugged outside zinc coated steel spreader arms
- Heavy duty hinged utility tray for holding tools and paint accessories (10" x 10")
- Heavy-duty slip-resistant safety shoes

MODEL	SIZE	OPEN HEIGHT	HIGHEST STANDING HEIGHT	BASE WIDTH	BASE DEPTH	APPROX. WEIGHT lbs
4404	4'	46"	24"	20"	29"	14
4406	6'	68"	46"	23"	41"	20
4408	8'	90"	68"	26"	54"	26
4410	10'	113"	91"	29"	66"	33
4412	12'	135"	114"	32"	78"	41
4414	14'	158"	134"	35"	88"	51
4416	16'	181"	160"	38"	102"	59

EXTRA-HEAVY DUTY ALUMINUM STEP

CSA Approved Grade 1, ANSI Type 1A

HIGH STRENGTH TO WEIGHT RATIO PROVIDES AN ECONOMICAL ALTERNATIVE FOR GENERAL CONTRACTOR WORK

- Super tough copolymer top for strength and durability
- Wide 3" slip-resistant serrated aluminum steps for safe climbing
- Rugged outside Zinc coated steel spreader arms
- Heavy duty hinged utility tray for holding tools and paint accessories (10 x 10)
- Heavy-duty slip-resistant safety shoes

MODEL	SIZE	OPEN HEIGHT	HIGHEST STANDING HEIGHT	BASE WIDTH	BASE DEPTH	APPROX. WEIGHT lbs
*3402	2'	22"	11"	16"	18"	5
*3403	3'	34"	23"	17"	24"	8
3404	4'	46"	24"	19"	29"	12
3405	5'	57"	34"	20"	35"	14
3406	6'	68"	46"	21"	41"	17
3408	8'	91"	68"	24"	54"	22
3410	10'	114"	91"	26"	66"	28

* no utility tray

**300 lb
RATED**

3400 SERIES



FEATHERLITE
INDUSTRIAL LADDERS

EXTRA-HEAVY DUTY ALUMINUM PLATFORM STEP

CSA Approved Grade 1, ANSI Type 1A

IDEAL FOR INDUSTRIAL FIXED HEIGHT WORK

- Large comfortable slip-resistant platform, 14" x 18"
- Wide 3 1/2" slip-resistant serrated aluminum steps for safe climbing
- Solid triangular braces on steps and rear horizontal struts provide unequalled rigidity
- Outside "J" spreader arms
- Heavy-duty slip-resistant safety shoes

300 lb
RATED

4500 SERIES



MODEL	SIZE	OPEN HEIGHT	HEIGHT TO PLATFORM	BASE WIDTH	BASE DEPTH	APPROX. WEIGHT lbs
4506	6'	68"	46"	24"	42"	22
4508	8'	93"	69"	27"	54"	28
4510	10'	113"	92"	30"	65"	35
4512	12'	135"	115"	33"	78"	43
4514	14'	157"	136"	36"	87"	52
4516	16'	180"	158"	39"	102"	60

HEAVY DUTY ALUMINUM PLATFORM STEP

CSA Approved Grade 1, ANSI Type 1

IDEAL FOR IN FIXED GENERAL HEIGHT WORK

- Large comfortable slip-resistant platform, 14" x 18"
- Wide 3" slip-resistant serrated aluminum steps for safe climbing
- Outside "J" spreader arms
- Heavy-duty slip-resistant safety shoes

250 lb
RATED

3500 SERIES



MODEL	SIZE	OPEN HEIGHT	HEIGHT TO PLATFORM	BASE WIDTH	BASE DEPTH	APPROX. WEIGHT lbs
3504	4'	46"	23"	21"	28"	13
3506	6'	68"	46"	24"	42"	19
3508	8'	90"	68"	26"	54"	24
3510	10'	114"	92"	29"	66"	30

LIGHT DUTY ALUMINUM PLATFORM STEP

CSA Approved Grade 3, ANSI Type 3

IDEAL FOR PAINTING AND CHORES AROUND THE HOUSE

- 1" tubular construction, makes this ladder light weight and allows for compact storage
- Handrail with comfort foam grip for added safety
- Fold down utility tray for tools and paint accessories
- Rubber slip-resistant safety feet
- Platform provides a large safe and comfortable standing area

200 lb
RATED

1300 SERIES



MODEL	SIZE	OPEN HEIGHT	HEIGHT TO PLATFORM	BASE WIDTH	BASE DEPTH	APPROX. WEIGHT lbs
1304	4'	55"	22"	18"	27"	8

aluminum

**300 lb
RATED**

4600 SERIES

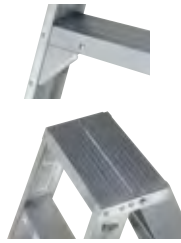

EXTRA-HEAVY DUTY ALUMINUM 2-WAY STEP

CSA Approved Grade 1, ANSI Type 1A

DOUBLE FRONT CONSTRUCTION ALLOWS TWO CLIMBERS TO ACCESS THE LADDER FROM OPPOSITE SIDES

- Wide aluminum top with extra-thick brackets for strength and durability
- Wide 3 1/2" slip-resistant serrated aluminum steps for safe climbing
- Solid triangular step braces provide unequalled rigidity
- Outside "J" spreader arms
- Heavy-duty slip-resistant safety shoes

MODEL	SIZE	OPEN HEIGHT	HIGHEST STANDING HEIGHT	BASE WIDTH	BASE DEPTH	APPROX. WEIGHT lbs
4606	6'	67"	46"	23"	56"	25
4608	8'	90"	68"	26"	73"	32
4610	10'	112"	90"	29"	89"	41

HEAVY DUTY 2-WAY STEP

CSA Approved Grade 1, ANSI Type 1

DOUBLE FRONT CONSTRUCTION ALLOWS TWO CLIMBERS TO ACCESS THE LADDER FROM OPPOSITE SIDES

- Aluminum top for strength and durability
- Wide 3" slip-resistant serrated aluminum steps for safe climbing
- Outside "J" spreader arms
- Heavy-duty slip-resistant safety shoes

**250 lb
RATED**



3600 SERIES



MODEL	SIZE	OPEN HEIGHT	HIGHEST STANDING HEIGHT	BASE WIDTH	BASE DEPTH	APPROX. WEIGHT lbs
3604	4'	44"	23"	19"	39"	14
3606	6'	68"	45"	21"	57"	21
3608	8'	90"	67"	24"	72"	29
3610	10'	112"	89"	26"	89"	36

3700 SERIES

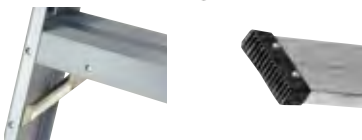

HEAVY DUTY ALUMINUM SAWHORSE

THE IDEAL DRYWALL AND GENERAL CONTRACTOR'S ACCESS TOOL

- Wide aluminum top for strength and durability
- Wide 3" slip-resistant serrated aluminum steps for safe climbing
- Outside "J" spreader arms
- Rubber slip-resistant safety shoes
- Different sizes can be combined for planking applications

MODEL	SIZE	OPEN HEIGHT	BASE WIDTH	BASE DEPTH	APPROX. WEIGHT lbs
3702	2'	23"	32"	25"	10
3703	3'	35"	34"	32"	14
3704	4'	47"	35"	39"	19

FEATHERLITE
INDUSTRIAL LADDERS

aluminum

**300 lb
RATED**

4100 SERIES



EXTRA-HEAVY DUTY ALUMINUM STRAIGHT LADDER

CSA Approved Grade 1, ANSI Type 1A

BUILT FOR DEMANDING INDUSTRIAL APPLICATIONS

- Rigid "Box Section" side rails, unequalled for strength and durability
- Yellow ABS, high impact non-marring end caps
- Slip-resistant round serrated aluminum rungs
- Heavy-duty ribbed swivel feet

MODEL	SIZE	OUTSIDE WIDTH	INSIDE WIDTH	APPROX. WEIGHT lbs
4108	8'	14 5/8"	12 7/8"	13
4110	10'	14 5/8"	12 7/8"	16
4112	12'	14 5/8"	12 7/8"	19
4114	14'	14 5/8"	12 7/8"	22
4116	16'	14 5/8"	12 7/8"	25
4118	18'	14 5/8"	12 7/8"	28
4120	20'	14 5/8"	12 7/8"	31
4122	22'	15 3/4"	13 3/4"	41
4124	24'	15 3/4"	13 3/4"	44

HEAVY DUTY STRAIGHT LADDER

CSA Approved Grade 1, ANSI Type 1

HIGH STRENGTH TO WEIGHT RATIO PROVIDES AN EASILY PORTABLE INDUSTRIAL STRAIGHT LADDER

- Heavy duty "C" channel rail construction
- Side rails: 2 1/2" x 1" for sizes 8' through 14'
- Side rails: 3" x 1" for sizes 16' through 20'
- Slip-resistant serrated "D" rungs for safe climbing and comfort
- Black ABS, high impact non-marring end caps
- Heavy-duty ribbed swivel feet

MODEL	SIZE	OUTSIDE WIDTH	INSIDE WIDTH	APPROX. WEIGHT lbs
7108	8'	16 3/4"	14 5/8"	10
7110	10'	16 3/4"	14 5/8"	13
7112	12'	16 3/4"	14 5/8"	15
7114	14'	16 3/4"	14 5/8"	18
7116	16'	16 3/4"	14 5/8"	23
7118	18'	16 3/4"	14 5/8"	27
7120	20'	16 3/4"	14 5/8"	29

**250 lb
RATED**

7100 SERIES



FEATHERLITE
INDUSTRIAL LADDERS

aluminum

**300 lb
RATED**

4200D SERIES



EXTRA-HEAVY DUTY ALUMINUM EXTENSION

CSA Approved Grade 1, ANSI Type 1A

OUR SIGNATURE PRODUCT—POSSIBLY THE BEST DESIGNED AND MANUFACTURED LADDER IN THE WORLD

- Rigid "Box Section" side rails, unequalled for strength and durability
- Side-mounted rope pulley and slide guide system keeps rope clear of climbers feet and allows easy raising and lowering of the fly section.
- Yellow ABS, high impact non-marring end caps
- Premium heavy-duty rung locks
- Slip-resistant serrated "D" rungs for safe climbing and comfort
- Heavy-duty ribbed swivel feet with ice pick
- 16' through 28' models have 2 7/8" x 7/8" side rails
- 32' through 44' models have 3 1/4" x 1" side rails

MODEL	SIZE	MAX. OPEN LENGTH	BASE SECTION		FLY SECTION		APPROX. WEIGHT lbs
			OUTSIDE WIDTH	INSIDE WIDTH	OUTSIDE WIDTH	INSIDE WIDTH	
4216D	16'	13'	17"	15 1/4"	14 1/2"	12 3/4"	29
4220D	20'	17'	17"	15 1/4"	14 1/2"	12 3/4"	37
4224D	24'	21'	17"	15 1/4"	14 1/2"	12 3/4"	44
4228D	28'	25'	17"	15 1/4"	14 1/2"	12 3/4"	50
4232D	32'	29'	18 1/2"	16 1/2"	15 7/8"	13 7/8"	69
4236D	36'	32'	18 1/2"	16 1/2"	15 7/8"	13 7/8"	78
4240D	40'	35'	18 1/2"	16 1/2"	15 7/8"	13 7/8"	86
4244D	44'	39'	18 1/2"	16 1/2"	15 7/8"	13 7/8"	94
*4360	60'	50'	21 3/4"	19"	16"	14"	128

*THREE SECTION EXTENSION, MIDDLE SECTION OUTSIDE WIDTH: 18 1/2", INSIDE WIDTH: 16 1/2"
*ROUND RUNG *NOT CSA APPROVED

EXTRA-HEAVY DUTY ALUMINUM EXTENSION

CSA Approved Grade 1, ANSI Type 1A

RUGGED "I" BEAM EXTENSION SUITABLE FOR DEMANDING INDUSTRIAL APPLICATIONS

- Heavy-duty "I" beam construction, 3 1/16" x 1 1/4" rails provide stability, torque resistance and high strength to weight ratio
- Heavy-duty serrated rungs prevent slipping for safe and sure climbing. (available in round or "D" profile)
- Yellow ABS, high impact non-marring end caps
- Premium heavy-duty rung locks
- Heavy-duty ribbed swivel feet with ice picks

MODEL	SIZE	MAX. OPEN LENGTH	BASE SECTION		FLY SECTION		APPROX. WEIGHT lbs
			OUTSIDE WIDTH	INSIDE WIDTH	OUTSIDE WIDTH	INSIDE WIDTH	
3216D	16'	13'	17 3/4"	15 1/4"	16 1/8"	13 5/8"	31
3220D	20'	17'	17 3/4"	15 1/4"	16 1/8"	13 5/8"	36
3224D	24'	21'	17 3/4"	15 1/4"	16 1/8"	13 5/8"	43
3228D	28'	25'	17 3/4"	15 1/4"	16 1/8"	13 5/8"	53
3232D	32'	29'	17 3/4"	15 1/4"	16 1/8"	13 5/8"	60
3236D	36'	32'	17 3/4"	15 1/4"	16 1/8"	13 5/8"	69
3240D	40'	35'	17 3/4"	15 1/4"	16 1/8"	13 5/8"	77

"D" RUNG

**300 lb
RATED**

3200 SERIES



FEATHERLITE
INDUSTRIAL LADDERS

ROLLING STEEL

MEETS OR EXCEEDS CSA SAFETY STANDARDS AS PER ANSI A14.7

NO HAND RAILS SERIES

- 15" Platform depth
- 1" 16 ga. Round tubing construction
- 3" Swivel spring loaded casters
- 24" wide x 7 1/2" deep non-slip perforated step material
- 26" Overall width
- No Hand rail
- Painted blue enamel

42" HAND RAILS SERIES

- 15" Platform depth
- 1" 16 ga. Round tubing construction
- 6" x 2" Polyolefin rear wheels
- 5" x 1 1/4" RSX rubber swivel casters
- 24" Wide x 7 1/2" deep non-slip perforated step material
- 42" High hand rail
- Painted blue enamel



NO HAND RAILS SERIES

MODEL	STEPS	PLATFORM HEIGHT	STEP WIDTH	BASE WIDTH	BASE DEPTH	WHEEL ASSEMBLY	SHIPPING SIZE	APPROX WEIGHT lbs
1NH	1	9"	24"	26"	19"	3" Spring Loaded Caster	26" x 20" x 10"	30
2NH	2	18"	24"	26"	24 1/2"	3" Spring Loaded Caster	26" x 24" x 18"	40
3NH	3	27"	24"	26"	29 1/2"	3" Spring Loaded Caster	26" x 31" x 27"	53
4NH	4	36"	24"	26"	32 1/2"	3" Spring Loaded Caster	26" x 40" x 36"	62
5NH	5	45"	24"	26"	38"	3" Spring Loaded Caster	26" x 44" x 45"	95

42" HAND RAILS SERIES

MODEL	STEPS	PLATFORM HEIGHT	STEP WIDTH	BASE WIDTH	BASE DEPTH	WHEEL ASSEMBLY	SHIPPING SIZE	APPROX WEIGHT lbs
1H	1	9"	24"	26"	19"	3" Spring Loaded Caster	26" x 20" x 52"	32
2H	2	18"	24"	26"	24 1/2"	3" Spring Loaded Caster	26" x 24" x 60"	42
3H	3	27"	24"	26"	29 1/2"	3" Spring Loaded Caster	26" x 31" x 69"	55
4H	4	36"	24"	33"	34 1/2"	5' Front Caster, 6" Rear Wheels	33" x 40" x 78"	87
5H	5	45"	24"	33"	40"	5' Front Caster, 6" Rear Wheels	33" x 44" x 87"	97
6H	6	54"	24"	33"	45 1/4"	5' Front Caster, 6" Rear Wheels	33" x 44" x 9'	111
7H	7	63"	24"	33"	50 1/2"	5' Front Caster, 6" Rear Wheels	33" x 44" x 10'	122
8H*	8	72"	28"	36"	55 3/4"	5' Front Caster, 6" Rear Wheels	36" x 37" x 10 1/2'	142
9H*	9	81"	28"	36"	61"	5' Front Caster, 6" Rear Wheels	36" x 37" x 11'	154
10H*	10	90"	28"	36"	66 1/4"	5' Front Caster, 6" Rear Wheels	36" x 37" x 12'	166
11H*	11	99"	28"	36"	71 1/2"	5' Front Caster, 6" Rear Wheels	36" x 37" x 13'	178
12H*	12	108"	28"	36"	76 1/4"	5' Front Caster, 6" Rear Wheels	36" x 37" x 14'	190
13H*	13	117"	28"	36"	82"	5' Front Caster, 6" Rear Wheels	36" x 37" x 15'	202
14H*	14	126"	28"	36"	87 1/4"	5' Front Caster, 6" Rear Wheels	36" x 37" x 15 1/2'	214
15H*	15	135"	28"	36"	92"	5' Front Caster, 6" Rear Wheels	36" x 37" x 16 1/2'	226
16H*	16	144"	28"	36"	97 3/4"	5' Front Caster, 6" Rear Wheels	36" x 37" x 17'	238

* collapsed for shipping

3-way & articulating

HEAVY DUTY ALUMINUM 3-WAY

CSA Approved Grade 1, ANSI Type 1

A TOUGH VERSATILE LADDER FOR TRADESMEN OR DIY'ERS

- Easily converts from a step ladder to extension to stairway ladder that locks surely and safely into all positions
- Durable extruded aluminum rails and slip-resistant serrated steps and rungs
- Heavy duty hardware to ensure rigidity in all positions
- Fixed rubber safety shoes on front section, swivel feet on back section
- Black ABS, high impact non-marring end caps



MODEL	STEP SIZE	EXTENSION SIZE	MAX. EXTENSION OPEN LENGTH	APPROX. WEIGHT lbs
2706	6'	12'	9'	22
2707	7'	14'	11'	25
2708	8'	16'	13'	28

ALUMINUM ARTICULATING LADDER

MODEL 3316 - CSA Approved Grade 1, ANSI Type 1A

MODEL 3312 - CSA Approved Grade 1, ANSI Type 1

A VERSATILE TOOL FOR A WIDE VARIETY OF COMMERCIAL AND RESIDENTIAL JOBS

- Compact and multifunctional
- Sturdy "C" channel rail construction
- Serrated rungs prevent slipping for safe sure climbing
- Positive, visual hinge locking indication in any position
- Folds easily for storage and transport
- 3316 has stabilizer feet on each end that provide superior stability
- 3312 has flared ends for excellent stability



MODEL	STEP SIZE	EXTENSION SIZE	SCAFFOLD SIZE	APPROX. WEIGHT lbs
3312	6'	12'	3'	26
3316	8'	16'	4'	46

HEAVY DUTY FIBERGLASS ARTICULATING LADDER

CSA Approved Grade 1, ANSI Type 1

A NON-CONDUCTIVE MULTI-PURPOSE LADDER FOR COMMERCIAL OR RESIDENTIAL JOBS

- Compact and multifunctional
- Sturdy non-conductive fiberglass "C" channel construction
- Serrated rungs prevent slipping for safe sure climbing
- Positive, visual hinge locking indication in any position
- Folds easily for storage and transport
- Stabilizer feet on each end that provide superior stability

MODEL	STEP SIZE	EXTENSION SIZE	SCAFFOLD SIZE	APPROX. WEIGHT lbs
3312FG	6'	12'	3'	30



FEATHERLITE
INDUSTRIAL LADDERS

JAWS TELESCOPIC LADDER

JLT SERIES - CSA Approved Grade 1, ANSI Type 1AA

JJT SERIES - CSA Approved Grade 1, ANSI Type 1

THE STRONGEST BEST BUILT MULTI-POSITION LADDER SYSTEM AVAILABLE

- Compact and multifunctional, Replaces all conventional ladders
- Easily folds for storage or transport
- Flared ends with slip-resistant feet provide superior stability in any position
- Polymer rung locks are virtually indestructible
- Extra deep side rails make Jaws stiffer and stronger
- Mechanical interlocking tooth hinges for superior strength and 5 locking positions
- Extruded 6061-T6 marine alloy—for strength and corrosion resistance
- Welded outer rungs
- JLT Series has Extra-strong "Box-beam" rails for maximum strength and durability
- JJT Series has wide inner steps for comfort



JJT SERIES



JLT SERIES



MODEL	FOLDED HEIGHT	EXTENSION RANGE	WORKING HEIGHT	STEP LADDER RANGE	SCAFFOLD HEIGHT	APPROX. WEIGHT lbs
JJT 14	3'5"	6'3" to 10'6"	6'3" to 14'0"	3'2" to 5'3"	Up to 3'	21
JJT 17	4'5"	7'3" to 14'6"	7'3" to 17'0"	4'2" to 7'3"	Up to 4'	26
JLT 18	4'9"	9'0" to 15'0"	9'0" to 18'0"	4'6" to 7'6"	Up to 4'	36
JLT 22	5'9"	11'0" to 19'0"	11'0" to 22'0"	5'6" to 9'6"	Up to 5'	41
JLT 26	6'9"	13'0" to 23'0"	13'0" to 26'0"	6'6" to 11'6"	Up to 6'	50

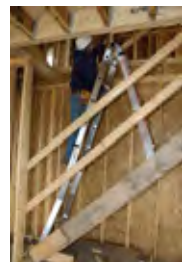
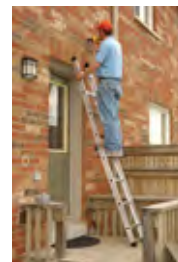

Leg Leveler Part #JLL30



Wall Stand-off Part #WSO40



Step/Tray Part #JIS10 *JLT Series Only



Utility Tray Part #JUT20

accessories & replacement parts



Utility Tray Part #99163
fits 6300, 6400, 6900 Series



Utility Tray Part #99019
fits 2400 Series



Wall Stand-off
Part #WSO40



Wheels
Part #99326



LEVELOK Leg Leveler
Part #21145



Wall Stand-off
Part #99066



Roof Ladder Lock
Part #99062



P= PAIR S=SINGLE

FIBERGLASS STEPS
6900
6800
6600 (4' to 12')
6600 (14' & 16')
6500
6400
6300
5900
5800

TOP CAP S	SAFETY FEET 4	UTILITY TRAY S
99180	99003	99163
99180	99105	N/A
N/A	99004	N/A
N/A	99005	N/A
N/A	99105	N/A
99180	99003	99163
99180	99105	99163
99180	N/A	99163
99002	99105	99006

ALUMINUM STEPS
4600
4500
4400
3700
3600
3500
3400
2400
1400

TOP CAP S	SAFETY FEET 4	UTILITY TRAY S
N/A	99104	N/A
N/A	99102	N/A
99180	99102	99164
N/A	99139	N/A
N/A	99106	N/A
N/A	99105	N/A
99181	99105	99163
99002	99101	99019
99016	99008	99007

* Spreader arms are available, please specify left or right side, model and size
* NEW RUBBER BOOT FOR 6400, 6900, AND 6600

* Spreader arms are available, please specify left or right side, model and size

FIBERGLASS EXTENSIONS
9200
6900
6300
6200
6200D (16' to 32')
6200D (36' & 40')
5800
5700
5400

END CAP P	PULLEY & BRACKET S	RUNG LOCKS P	FLY RUNG S	BASE RUNG S	SAFETY FEET P
99122	99017	99186	99170-F	99170-B	99131
99122	99011	99186	N/A	N/A	99131
99122	99011	99186	N/A	N/A	99131
99122	99009	99128	99171-F	99171-B	99123
99122	99009	99186	99170-F	99170-B	99123
99018	99010	21122	99012-F	99012-B	99014
99122	99011	99186	N/A	N/A	99131
99122	99009	99128	99171-F	99171-B	99131
99122	99135-ET	99128	99171-F	99171-B	99123

* Replacement rope available, please specify ladder model and size when ordering (available in White Marine Grade, Yellow Poly or Black Poly.)

replacement parts

ALUMINUM EXTENSIONS

4360
 4200D (16' to 28')
 4200D (32' to 44')
 3200
 3200D
 2200 (16' TO 20')
 2200 (24' TO 40')
 1200

END CAP P	RUNG LOCKS P	SAFETY FEET P
99155	99191	99116
99118	99185	99116
99119	99185	99116
99113	99128	99114
99113	99186	99114
99172	99186	99109
99173	99186	99109
99015	99186	99109



* Replacement rope available, please specify ladder model and size when ordering (available in White Marine Grade, Yellow Poly or Black Poly.)

STRAIGHTS

7100
 6100
 6100PS
 6100MH
 5700
 4100 (8' to 10')
 4100 (22' to 24')

END CAP P	RUNG S	FEET P
99172	N/A	99108
99122	99171-B	99123
99122	99171-B	99123
99122	99171-F	99127
99122	99171-B	99131
99118	N/A	99116
99119	N/A	99116

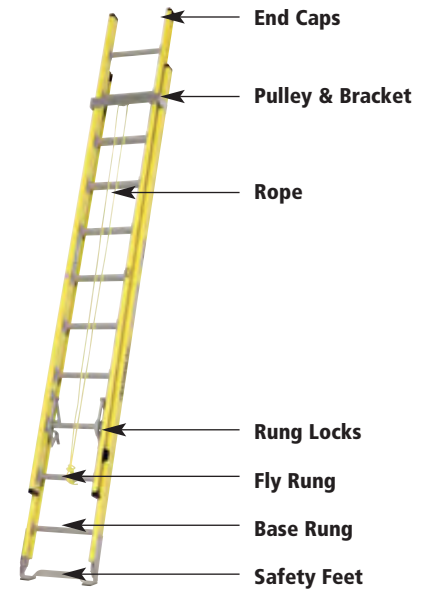

* Replacement rope available, please specify ladder model and size when ordering (available in White Marine Grade, Yellow Poly or Black Poly.)

JAWS

JLT26
 JLT22
 JLT18
 JJT17
 JJT14

COMPLETE' HINGE LOCK S	KNOB AND BOLT S	ELD S	SPREADER BAR S	RUNG END CAP S	OUTSIDE SECTION S	OUTSIDE FOOT S	INSIDE FOOT S
ZZZ06	ZZZ02A	ZZZ07	ZZZ10	ZZZ03	ZZZ26	ZZZ08	ZZZ09
ZZZ06	ZZZ02A	ZZZ07	ZZZ10	ZZZ03	ZZZ12	ZZZ08	ZZZ09
ZZZ06	ZZZ02A	ZZZ07	ZZZ10	ZZZ03	ZZZ11	ZZZ08	ZZZ09
ZZZ13	ZZZ02B	ZZZ14	ZZZ10	ZZZ03	ZZZ19	ZZZ15	ZZZ16
ZZZ13	ZZZ02B	ZZZ14	ZZZ23	ZZZ03	ZZZ18	ZZZ15	ZZZ16

MULTIS

3312
 3316
 3312FG

KNOB AND BOLT S	Foot S
ZZZ02B	ZZZ21
ZZZ02A	N/A
ZZZ02B	N/A



FEATHERLITE
 INDUSTRIAL LADDERS

SOLAR®



**SOL-1007C
Battery Charger**

- 6/2 Amp, 6/12 Volt
- 6 Amp, 6/12 Volt moderate charge
- 2 Amp, 12 Volt slow charge/warming



**SOL-1010C
High Rate Battery Charger**

- 10/2 Amp, 6/12 Volt
- 10 Amp, 6/12 Volt moderate charge
- 2 Amp, 12 Volt slow charge/warming



**SOL-1014C
Pulse Automatic Battery Charger**

- 10/2 Amp, 6/12 Volt moderate charge
- 2 Amp, 12 Volt slow charge/warming
- Automatic mode monitor to avoid overcharging



**SOL-1050C
Battery Charger/Engine Starter**

- 10/2/55 Amp, 6/12 Volt manual
- 95 Amp maximum output
- 55 Amp, engine starter
- 10 Amp, 6/12 Volt moderate charger
- 2 Amp, 12 Volt slow charge/warming



**SOL-1060C
Fully Automatic Battery Charger/Engine Starter/Monitor**

- 105 Amp maximum output
- 55 Amp, UL rated engine starter
- 10 Amp, 6/12 Volt moderate charger
- 2 Amp, 12 Volt slow charge/warming



**SOL-1160
Battery Charger/Engine Starter/Monitor**

- Fully automatic 15/2/100 Amp
- 145 Amp maximum output
- 100 Amp UL rated engine starter
- 15 Amp, 6/12 Volt moderate charge
- 2 Amp, 12 Volt slow charge



**SOL-1002C
On Board Charger**

1.5 Amp trickle charging and maintaining of 12 Volt batteries. Can be mounted permanently on vehicle.

**CEN-3R101
Coolant & Battery
Refractometer**



Measure freezing point of either propylene or ethylene glycol based cooling systems.

- Range: 32°F to -60°F (0°C to -50°C)



**SOLAR
OCTANE SERIES**



**SOL-OS6110
12 Volt Battery Charger with Engine Start**

- Charge Rates: 40A/15A/2A
- Engine Starting Amps: 200A
- Cable Length/Gauge: 72"/6 AWG
- Ship Weight: 43 lbs
- Warranty: 2 years limited



**SOL-OS6120
6/12 Volt Battery Charger/Starter/Tester**

- Charge Rates: 6V - 40A; 12V - 40A/15.
- Engine Starting Amps: 6V - 130A; 12V - 200A
- Cable Length/Gauge: 72"/6 AWG
- Ship Weight: 43 lbs
- Warranty: 2 years limited



**SOL-OS6130
6/12 Volt Battery Charger/Starter/Tester**

- Charge Rates: 6V - 60A; 12V - 60A/40A/2A
- Engine Starting Amps: 6V - 185A; 12V - 250A
- Cable Length/Gauge: 72"/6 AWG
- Ship Weight: 51 lbs
- Warranty: 2 years limited



**SOL-OS6140
6/12 Volt Battery Charger/Starter/Tester**

- Charge Rates: 6V /12V - 0.3 - 60 Amps
- Engine Starting Amps: 6V - 185A; 12V - 225A
- Cable Length/Gauge: 72"/6 AWG
- Ship Weight: 56 lbs
- Warranty: 2 years limited



**SOL-OS6150
6/12/24 Volt Fleet Charger with Engine Starter**

- Charge Rates: 6V - 60A; 12V - 60A/40A; 24V - 30A
- Engine Starting Amps: 6V - 160A; 12V - 225A
- Cable Length/Gauge: 72"/6 AWG
- Ship Weight: 54 lbs
- Warranty: 2 years limited



SOL-ES2500
900 Peak Amps 12V
Booster Pac™

- Compact, portable power supply
- Powerful enough to jump start car, truck and marine engines
- Excellent for service stations, car dealerships, tow trucks, body shops
- 23" cable and heavy duty clamps
- DC accessories outlet



SOL-ES5000
1500 Peak Amps 12V
Professional Booster Pac™

- Superior cranking power - the Genesis battery is up to three times as powerful as equally sized conventional batteries
- Deep discharge recovery - can recover from extreme discharged conditions
- 43" cable and heavy duty clamps
- DC accessories outlet



SOL-JNC660
1700 Peak Amps
12 Volt Jump Starter

- Battery status indicator gauge
- 46" heavy-duty #4 cables
- DC outlet to power 12 Volt accessories
- 1 year limited warranty



SOL-ES6000
3000 Peak Amps
Truck Pac™

- 12 Volt portable power source
- 12 Volt dedicated high output unit
- Dual high performance ES Series batteries
- 54" cable and heavy duty clamps



SOL-ES8000
1500 Peak Amps 24V
Truck Pac™

- 24 Volt portable power source
- 24 Volt dedicated high output unit
- Dual ES Series batteries
- 54" cable and heavy duty clamps



SOL-ES1224
3200/1600 Peak Amps
12/24V Truck Pac™

- 2 gauge 60" cable and heavy duty clamps
- Two 12V ES Series batteries
- 12V systems use batteries in parallel
- 24V systems use batteries in series
- Charger included



SOL-BA5
12 Volt Electronic Battery Tester

- Tests multiple battery types, including Conventional, Maintenance-Free, AGM, Gel Cell, Marine and Deep Cycle batteries
- Operating range: 100 - 1200 CCA (< +/-10% Tolerance); 7V-15V
- Reverse polarity and over-voltage protection
- One year limited warranty



SOL-BA7
12 Volt Electronic Battery & System Tester

- Tests multiple battery types, including Conventional, Maintenance-Free, AGM, Gel Cell, Marine and Deep Cycle batteries
- Operating range: 100 - 1200 CCA (< +/-10% Tolerance); 7V-15V
- Reverse polarity and over-voltage protection
- One year limited warranty



SOL-BA327
Digital Battery and System Tester with Integrated Printer

- 6 and 12 Volt battery testing
- 6, 12 and 24 Volt system testing
- 40-2000 CCA operating range
- Compatible with many battery types, including flooded, AGM and Gel Cell
- Extra-long 10' leads
- Backlit screen for clear viewing in low light
- Storage case

Pro-Logix Automatic Battery Chargers

- Active Filtering Technology with Charge Control Circuitry adjusts power delivery based on the characteristics of the battery being charged
- Quad-Phase charging process delivers optimal charge
- Compatible with a wide variety of battery types and sizes, including Conventional, Maintenance Free, AGM, Gel Cell, Deep Cycle and Marine batteries



SOL-PL2208
8 Amp Automatic Charger

SOL-PL2212
12 Amp Automatic Charger

SOL-PL2216
16 Amp Automatic Charger



- SOL-Pi1500X**
150W Power Inverter
- Ideal for powering small electronic devices
 - 150W Continuous/300W Peak
 - (1) 110 Vac outlet
 - (1) USB outlet
 - 12V Adapter power connection



- SOL-Pi15000X**
1500W Power Inverter
- 1500W Continuous/3000W Peak
 - **Digital display** provides status of input voltage and output wattage
 - (3) AC outlets
 - Includes mounting plate

- SOL-Pi12000X**
1200W Power Inverter
- Designed to deliver power to a wide variety of electronics, appliances and power tools.
 - 1200W Continuous/2400W Peak
 - (2) 110 Vac outlets
 - Battery cable power connection

- SOL-Pi20000X**
2000W Power Inverter
- 2000W Continuous/4000W Peak
 - **Digital display** provides status of input voltage and output wattage
 - (3) AC outlets
 - Includes mounting plate



CIA-5640R
26 Watt Professional Work Light
 • 12 Amp tool tap
 • 40 feet, 16/3 SJT heavy duty cord

CIA-5825R
13 Watt Fluorescent Work Light with Spot Work Light & Tool Tap
 • 40 feet, 16/3 SJT Cord, metal reel
 • 10,000 hour rated bulb
 • 10 amp tap



CIA-SL8903
50' 14/3 SJTW Triple Tap Professional Retractable Cord Reel
 • 13 Amp max. rating
 • 13 Amp circuit breaker
 • 3 grounded receptacles
 • Brackets



CIA-SL8907
13 Watt, 50' 14/3 SJTW Professional Fluorescent Worklight on Retractable Reel
 • 13 Amp max. rating
 • 13 Amp circuit breaker
 • Impact resistant housing
 • Brackets and magnet included



CIA-5140R
Incandescent Reel-Type Utility Light
 • 40 feet, 16/3 SJT black cord with on/off switch and 10 Amp tap
 • Metal cage



CIA-5430R
Heavy Duty Triple-Tap Retractable Reel
 • 30 feet, 16/3 SJT black cord
 • 10 Amp rating



CIA-SL8908
26 Watt, 50' 14/3 SJTW Professional Fluorescent Worklight on Retractable Reel
 • Twice the light!
 • 13 Amp max. rating
 • 13 Amp circuit breaker
 • Shatter resistant lens
 • Brackets and magnet included



CIA-SL976
26 Watt Professional Fluorescent Angle Light
 • 25' 16/3 SJT cord
 • 12 Amp tap



CIA-5935
13 Watt Professional Tubular Fluorescent Light with Spot Work Light & Tool Tap
 • 25' 16/3 SJT cord
 • 12 Amp tap
 • Clear top for spot lighting



Professional Incandescent Trouble Lights with Metal Cage
 • 16/3 SJTOW-A yellow cord
 • On/Off switch
 • 14.4 Amp tap

CIA-5125
25 Feet

CIA-5150
50 Feet

CIA-SL103
Replacement Fluorescent Lamp
 13 Watt/7000K



BAY-NSP1260
11" Three-Mode Multi-Function™ Night Stick®
 • Flashlight mode:
 1 LED, 150 Lumens, 10 hours run time
 • Floodlight mode full power:
 60 LED, 120 lumens, up to 4 hours run time
 • Floodlight mode half power:
 60 LED, 60 lumens, up to 10 hours run time
 • Dual-light mode:
 66 LED, 270 lumens, up to 3 hours run time
 • Includes: 2 AA batteries, clip magnet and dual position stand
 • 1 year warranty



BAY-NSP1136
8.8" Dual-Mode Multi-Function™ Pocket Night Stick®
 • Flashlight: 65 lumens, 12 hours run time
 • Floodlight: 72 lumens, 7 hours run time
 • Dual-light: 5 hours run time
 • Bright LEDs, 35,000 hour life
 • Rugged housing
 • Includes (4) AAA alkaline batteries
 • Weight: 5.7 oz
 • 1 year warranty



CIA-SL1006
1000 Watt Twin Head Worklight and Stand
 • Dual 500 Watt halogen fixtures mounted to a removable light track
 • Adjustable 8' tripod
 • 18/3 SJTW cord
 • Includes a spare bulb and case



CIA-SL1003
500 Watt Halogen Worklight with Stand
 • 6 ft. 18/3 SJTW cord
 • Weatherproof ON/OFF switch
 • Tempered glass lens

GLOBE



PORTABLE HALOGEN LAMPS 500W.
 PEDESTAL ONE HEAD 500W. HALOGEN LAMP
 PEDESTAL 2 X 500W HEADS HALOGEN LAMP



MULTI-PLUS 6



HALOGEN LAMPS
 150 WATTS - 130V.
 300 WATTS - 130V.
 500 WATTS - 130V.



ROUGH SERVICE BULBS
 50W. - 100W. - 150W.



FLUORESCENT 48" - 72"



FLOOD LAMPS
 50W.-75W.-100W.-150W.

WOODS



EXTENSION CORDS
 No.10019 12/3 x 50'
 No.10020 12/3 x 100'



EXTENSION CORDS (ORANGE)
 No. 403 16/3 x 3M.
 No. 405 16/3 x 5M.
 No. 410 16/3 x 10M.
 No. 415 16/3 x 15M.

EXTENSION CORDS (YELLOW)

No. 515 14/3 x 15M.
 No. 530 14/3 x 30M.

EXTENSION CORDS (ORANGE)

No. 615 14/3 x 15M.
 No. 630 14/3 x 30M.



TROUBLE LAMPS
 No. D210
 No. D310
 No. D315

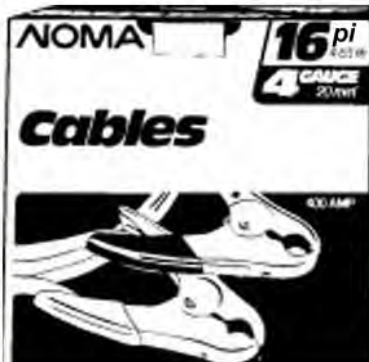

ELECTRICAL WIRE 16/2 - 16/3
 ROLLS OF 250'

EAGLE

CONNECTORS





Specification Grade Plugs and Connectors

2 Pole, 2 Wire
15A 125V

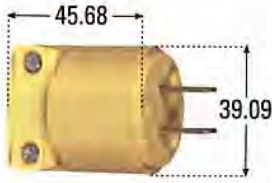

4862



4882



4862AN



3862

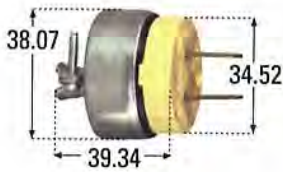

2862



2882



254

Specification Grade Plugs and Connectors

Features:

- Solid brass plug blades are firmly embedded in body.
- Terminal screw clamps are designed to contain wire and prevent binding.
- Terminal screws backed out — ready for wiring.
- Terminals in individual chambers to positively insulate conductors.
- Vinyl angle plugs have eight possible positions for maximum convenience.

Vinyl Plugs and Connectors

Catalogue No.

Rating A V	EEMAC	Description	Cord Diameter	Colour	Plug	Connector
15 125	1-15	Straight	6.35- 16.62mm	Yellow	4862	4882
		Angle	6.35- 16.62mm	White	4862ANW	—

Nylon Kwiklok Plugs and Connectors

Catalogue No.

Rating A V	EEMAC	Description	Cord Diameter	Colour	Plug	Connector
15 125	1-15	Straight	6.35- 17.0mm	Yellow	3862	3882

Vinyl Armoured Plugs and Connectors

Catalogue No.

Rating A V	EEMAC	Description	Cord Diameter	Colour	Plug	Connector
15 125	1-15	Straight	6.35- 15.86mm	Yellow	2862	2882
		Straight Polarized	6.35- 15.86mm	Yellow	2862-6	—
		Straight	6.35- 15.23mm	Black	—	254

All measurements in this catalogue are expressed in mm (millimeters) unless otherwise indicated.



1-15P



1-15R

**Straight
Blade
Plugs and
Connectors**

**EAGLE
ELECTRIC**

PORTABLE LAMPS AND BATTERIES



6 VOLTS LANTERN



6 VOLTS BATTERIES



RADAR LIGHT

RAYOVAC



MAG-LITE



Mini Maglite 2 AA batteries



Maglite 2 to 6 "C" batteries



Maglite 2 to 6 "D" batteries



F-2698-2 2 x 2 "D" batteries rubber lamp



F-2440-2B tough plastic 2 x 2 "D" batteries lamp

DURACELL



MN 1604-1 9 VOLTS



MN 2400-1 "AAA" 1.5 VOLTS



MN 1500-1 "AA" 1.5 VOLTS



MN 1400-1 "C" 1.5 VOLTS



MN 1300-1 "D" 1.5 VOLTS

ENGINEERING FILES



FARMER'S FILE (AXE FILE)

General purpose files for sharpening axes, mowers, scythes and other edge tools - Parallels in both width and thickness - Self handled - Single cut on both sides - Not cut on edges.

PRODUCT NUMBER	DESCRIPTION	CUT	PKG.
531128	8" Farmer's File	Second	12
531130	10" Farmer's File	Second	12

TAPER SAW FILE

Designed especially for use on saw and blade teeth - Slim for sharpening saws with 6 to 8 teeth per inch - X slim for sharpening saws with 8 to 13 teeth per inch - Triangular section - 60° angles between 3 sides - Equal sides taper towards point - Single cut on edges and sides - Cross dimensions become smaller on extra slim.



PRODUCT NUMBER	DESCRIPTION	CUT	PKG.
532522	6"	Slim	12
532524	6"	Extra Slim	12

Files must be bought in package quantities or multiples thereof.

PIPELINER FILE

Designed specifically for use on steel pipe applications. Half round section which is flat on one side and curved on the other - parallel in both width and thickness - single cut.



PRODUCT NUMBER	DESCRIPTION	CUT	PKG.
532542	14" Half Round Pipeliner	Bastard	6

FILE CARDS

Used for cleaning debris out of all types of file teeth to extend life and cutting action.

PRODUCT NUMBER	DESCRIPTION	PKG.
532911	File Card	12

JET FILE HANDLES

PRODUCT NUMBER	DESCRIPTION	CUT	PKG.
532901	1	Small Files	12
532902	2	4" Files	12
532903	3	5" Files and Chain Saw Files	12
532904	4	6" Files	12
532905	5	8" Files	12
532906	6	10" Files	12
532907	7	12" Files	12
532908	8	14" Files	12

JET-KUT™ PREMIUM ENGINEERING FILES



ROUND FILES

For use on various size holes - Especially designed to file or enlarge holes, circular openings or rounded grooves too small for half round file - With a round section, it tapers toward the point - Bastard and 2nd Cut file is double cut - Smooth is single cut.

PRODUCT NUMBER	DESCRIPTION	CUT	PKG.
531606	6" Round File	Bastard	12
531608	8" Round File	Bastard	12
531610	10" Round File	Bastard	12
531612	12" Round File	Bastard	6
531626	6" Round File	Second	12
531628	8" Round File	Second	12
531630	10" Round File	Second	12
531632	12" Round File	Second	6
531646	6" Round File	Smooth	12
531648	8" Round File	Smooth	12
531650	10" Round File	Smooth	12
531652	12" Round File	Smooth	6

FLAT FILES

General purpose file for smoothing surfaces and rapidly removing sharp edges and burs - For use on iron and steel flatwork - Regular square section - Tapers off in both width and thickness toward the point - Double cut on both sides - Single cut on edge.

PRODUCT NUMBER	DESCRIPTION	CUT	PKG.
531306	6" Flat Files	Bastard	12
531308	8" Flat Files	Bastard	12
531310	10" Flat Files	Bastard	12
531312	12" Flat Files	Bastard	6
531314	14" Flat Files	Bastard	6
531326	6" Flat Files	Second	12
531328	8" Flat Files	Second	12
531330	10" Flat Files	Second	12
531332	12" Flat Files	Second	6
531334	14" Flat Files	Second	6
531346	6" Flat Files	Smooth	12
531348	8" Flat Files	Smooth	12
531350	10" Flat Files	Smooth	12
531352	12" Flat Files	Smooth	6
531354	14" Flat Files	Smooth	6

THREE SQUARE FILES

For filing internal angles or cleaning out corners inaccessible to flat files - Also for filing taps and cutters in the annealed state - Triangular section 60° angles between three sides - Surface tapers toward the point - All sides are double cut.

PRODUCT NUMBER	DESCRIPTION	CUT	PKG.
531806	6" Three Square	Bastard	12
531808	8" Three Square	Bastard	12
531810	10" Three Square	Bastard	12
531826	6" Three Square	Second	12
531828	8" Three Square	Second	12
531830	10" Three Square	Second	12
531846	6" Three Square	Smooth	12
531848	8" Three Square	Smooth	12
531850	10" Three Square	Smooth	12

HALF ROUND FILES

General purpose file for filing both flat and concave surfaces - Also for rounding out holes as well as leaving a smooth finish - Half round section, which is flat on one side and curved on the other - Tapers toward the point and has double cut sides.

PRODUCT NUMBER	DESCRIPTION	CUT	PKG.
531406	6" Half Round	Bastard	12
531408	8" Half Round	Bastard	12
531410	10" Half Round	Bastard	12
531412	12" Half Round	Bastard	6
531414	14" Half Round	Bastard	6
531426	6" Half Round	Second	12
531428	8" Half Round	Second	12
531430	10" Half Round	Second	12
531432	12" Half Round	Second	6
531434	14" Half Round	Second	6
531446	6" Half Round	Smooth	12
531448	8" Half Round	Smooth	12
531450	10" Half Round	Smooth	12
531452	12" Half Round	Smooth	6
531454	14" Half Round	Smooth	6

CHAIN SAW FILES

Designed specifically for filing the collets of chain saws - Special round file with special spiral double cut edges.

PRODUCT NUMBER	DESCRIPTION	CUT	PKG.
531205	8"x5/32" Round	Double	12
531206	8"x3/16" Round	Double	12
531207	8"x7/32" Round	Double	12

MILL FILES

General purpose file for sharpening saws, axes, farm tools and other edged tools - Also used in lathe work, draw filing and finishing of hard materials - Regular square section - Tapers in width toward the point - 2 Square edges - Single cut on both sides and edges.

PRODUCT NUMBER	DESCRIPTION	CUT	PKG.
531506	6" Mill File	Bastard	12
531508	8" Mill File	Bastard	12
531510	10" Mill File	Bastard	12
531512	12" Mill File	Bastard	6
531548	8" Mill File	Smooth	12
531550	10" Mill File	Smooth	12
531552	12" Mill File	Smooth	6

FILE MAINTENANCE INSTRUCTIONS

- Hold firm
- Cut on forward stroke only
- Use full length of file on each stroke

MEASUREMENTS

The length of the file is the measurement from point to shoulder, exclusive of the tang.

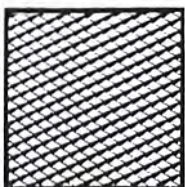

Bastard

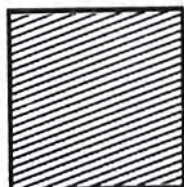

Second Cut

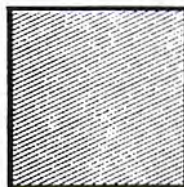

Smooth

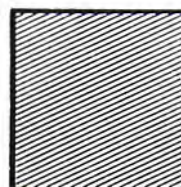

Single cut



Double cut

HACKSAW BLADES



12" BI-HARD COBALT

JET premium grade Bi-Hard Cobalt hacksaw blades are made of high quality cobalt, heat treated to four hardnesses across the blade. An excellent performing, shatterproof, long lasting blade for a multitude of applications.

PRODUCT NUMBER	SIZE	TEETH	PKG.	BOX
566231	12"x1/2"x.025	18TPI	10	100
566232	12"x1/2"x.025	24TPI	10	100
566233	12"x1/2"x.025	32TPI	10	100



CARBIDE CIRCULAR SAW BLADES



JET-KUT™

MULTI-PURPOSE CARBIDE CIRCULAR SAW BLADES

The blade that will do it all! JET-KUT multi-purpose blades are the only circular saw blades needed for most construction, renovation, light metal fab, extrusion, manufacturing, siding and roofing work. JET-KUT multi-purpose blades are ideal for use on wood, nail embedded wood, plastics, pipe, tin, copper, brass, aluminum, composites, extrusions and even smaller dimension mild steel. This is great news for the professional user; you can now switch from one material to the next without changing blades. German engineering has combined top grade tungsten carbide, a special tooth configuration, high technology bonding agents and first quality steel blanks to make JET-KUT the best multi-purpose blade available today.

PRODUCT NUMBER	MODEL NUMBER	SIZE	MACHINES USED ON
566542	PRED-748T	7-1/4"x5/8" - 48 Tooth	circular saws
566553	PRED-848T	8"x5/8" - 48 Tooth	circular saws
566577	PRED-1054T	10"x5/8" - 54 Tooth	mitre and table saws

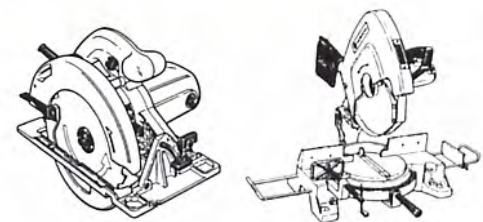

JET-KUT™

CARBIDE CIRCULAR SAW BLADES

JET-KUT carbide circular saw blades come in a wide range of sizes and types. These industrial quality blades are ideal for use on circular saws, table saws and mitre saws. Heavy duty carbide tips are securely fastened to SAE 1080 carbon steel plates which are hardened to R.C. 40+, offering straight smooth cuts and long life.

PRODUCT NUMBER	SIZE (DIA. x HOLE)	TEETH	APPLICATION	MACHINES USED ON
566540	7-1/4"x5/8" (Dia.)	24T	wood	circular saws
566541	7-1/4"x5/8" (Dia.)	40T	wood	circular saws
566551	8-1/4"x5/8" (Dia.)	24T	wood	circular saws
566552	8-1/4"x5/8" (Dia.)	40T	wood	circular saws
566573	10"x5/8"	24T	wood	mitre and table saws
566574	10"x5/8"	40T	wood	mitre and table saws
566575	10"x5/8"	60T	wood	mitre and table saws
566576	10"x5/8"	80TC	aluminum	mitre and table saws



RESIN FIBRE SANDING DISCS



4" - 7" ALUMINUM OXIDE

**GENERAL
PURPOSE**

JET aluminum oxide discs are the standard of the metalworking industry and are the most popular discs used for general metal removal. Excellent for use on all metal grinding and finishing applications, rust and scale removal and deburring operations.

PRODUCT NUMBER	SIZE	GRIT	PKG. / CASE
502402	4"x5/8"	24	25/100
502403	4"x5/8"	36	25/100
502404	4"x5/8"	50	25/100
502405	4"x5/8"	60	25/100
502406	4"x5/8"	80	25/100
502407	4"x5/8"	100	25/100
502408	4"x5/8"	120	25/100
502411	4-1/2"x7/8"	16	25/100
502412	4-1/2"x7/8"	24	25/100
502413	4-1/2"x7/8"	36	25/100
502414	4-1/2"x7/8"	50	25/100
502415	4-1/2"x7/8"	60	25/100
502416	4-1/2"x7/8"	80	25/100
502417	4-1/2"x7/8"	100	25/100
502418	4-1/2"x7/8"	120	25/100
502421	5"x7/8"	16	25/100
502422	5"x7/8"	24	25/100
502423	5"x7/8"	36	25/100
502424	5"x7/8"	50	25/100
502425	5"x7/8"	60	25/100
502426	5"x7/8"	80	25/100
502427	5"x7/8"	100	25/100
502428	5"x7/8"	120	25/100
502441	7"x7/8"	16	25/100
502442	7"x7/8"	24	25/100
502443	7"x7/8"	36	25/100
502444	7"x7/8"	50	25/100
502445	7"x7/8"	60	25/100
502446	7"x7/8"	80	25/100
502447	7"x7/8"	100	25/100
502448	7"x7/8"	120	25/100

Discs sold in package quantities or multiples thereof



4 1/2" - 7" ALUMINA ZIRCONIA

**HIGH
PERFORMANCE**

Alumina Zirconia is a well established, high performance grain developed in the early seventies and is very popular where productivity and life are the important factors. It is a very sharp, tough grain that offers long life and aggressive cool cutting action. These discs are excellent for heavy weld and metal grinding on steel and stainless steel, particularly in coarse grits. Ideal for medium to heavy pressure grinding.

PRODUCT NUMBER	SIZE	GRIT	PKG. / CASE
502506	4-1/2"x7/8"	24	25/100
502507	4-1/2"x7/8"	36	25/100
502512	5"x7/8"	24	25/100
502513	5"x7/8"	36	25/100
502514	5"x7/8"	50	25/100
502516	5"x7/8"	80	25/100
502527	7"x7/8"	24	25/100
502528	7"x7/8"	36	25/100
502529	7"x7/8"	50	25/100



DIAMOND BLADES

JET-KUT™

4 - 10" DRY/WET CONTINUOUS RIM TILE BLADES

- JET-KUT™ Premium Series tile saw blades are continuous rim, dry/wet cutting diamond blades for use on all popular makes of tile saws
- Model TC5 may also be used on right angle grinders
- Model TC7-2X may also be used on angle grinders or circular saws
- For use on tub saws

PREMIUM SERIES

PROD. NO.	MOD. NO.	Size	Application	Rim Height
568601	TC4-2X	4" x .070 x 20mm(5/8")	Ceramic tile	.197"
568614	TC5	5" x .070 x 7/8"(5/8",20mm)		.197"
568631	TC7-2X	7" x .067 x Dia.(7/8",5/8")		.197"
568641	TC8-2X	8" x .095 x 5/8"		.197"
568661	TC10-2X	10" x .095 x 5/8"		.197"



- JET-KUT Super Premium Series tile saw blades are continuous rim, dry/wet cutting diamond blades for use on tile saws
- High diamond concentration makes these super high performance blades extremely fast cutting and long lasting. Ideal for the professional user cutting tile, ceramics, granite and thin marble

SUPER PREMIUM SERIES

PROD. NO.	MOD. NO.	Size	Application	Rim Height
567405	SPTC4	4" x .052 x 20mm(5/8")	Tile, ceramics, granite and thin marble under 1 cm	.295"
567430	SPTC8	8" x .067 x 5/8"		.295"
567440	SPTC10	10" x .067 x 5/8"		.295"



4" - 7" DRY TUCK POINTING BLADES

- Dry cutting diamond tuck pointing blades are used on angle grinders for fast efficient removal of mortar joints when restoring or repairing brick buildings

SUPER PREMIUM SERIES

PROD. NO.	MOD. NO.	Dimensions	Segment Height
568729	TDP04-150	4" x .250 x 7/8" (5/8")	.275"
568739	TDP05-150	5" x .250 x 7/8" (5/8")	.275"
568759	TDP07-150	7" x .250 x 7/8" (5/8")	.275"



4" - 7" DRY SEGMENTED CUP WHEELS

- Dry cutting segmented cup wheels are designed to remove concrete, masonry and stone at an extremely fast rate
- 5" available in single row and double row
- For use on angle grinders – 5/8"-11NC threaded

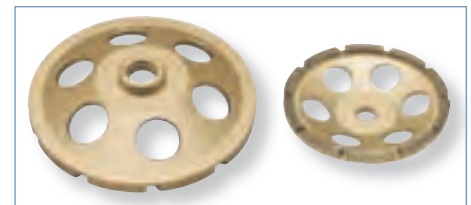

PREMIUM SERIES

PROD. NO.	MOD. NO.	Dimensions	Number of Rows
568501	DSW-4C	4" x 5/8" - 11	Single
568503	DSW-5C	5" x 5/8" - 11	Single
568504	DDW-5C	5" x 5/8" - 11	Double
568507	DSW-7C	7" x 5/8" - 11	Single
568508	DSW-7D	7" x 5/8" - 11	Double

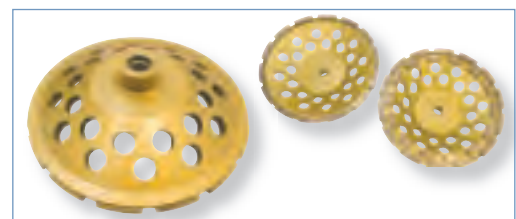

DIAMOND BLADES

JET-KUT™

12" - 16" DRY SEGMENTED BLADES FOR PORTABLE GAS AND ELECTRIC SAWS

- JET-KUT™ high speed dry cutting diamond blades are extremely popular for use on gas powered and portable electric machines
- The most efficient and best all round method of cutting masonry, concrete, asphalt, and interlocking paving brick
- Constant depth of cut, faster cutting action, far longer life and less down time make dry diamond blades a better value than conventional abrasive blades
- To ensure adequate cooling and long blade life dry diamond blades should be operated using an intermittent cutting action



ECONO SERIES

PROD. NO.	MOD. NO.	Dimensions	Application	Segment Height
569801	EHS-12C-20M	12" x .110 x 20mm	cured concrete, masonry materials	.275"
569811	EHS-14C-20M	14" x .110 x 20mm		.275"



PREMIUM SERIES

PROD. NO.	MOD. NO.	Dimensions	Application	Segment Height
568812	HSD-12C	12" x .110 x 1"	cured concrete, masonry materials	.275"
568814	HSD-12C-20M	12" x .110 x 20mm		.275"
568824	HSD-14C	14" x .110 x 1"		.275"
568826	HSD-14C-20M	14" x .110 x 20mm		.275"
568836	HSD-16C	16" x .138 x 1"		10mm
568829	HSD-14G-20M	14" x .125 x 20mm	granite	10mm
568813	HSD-12A	12" x .110 x 1"	asphalt, green concrete	.275"
568815	HSD-12A-20M	12" x .110 x 20mm		.275"
568825	HSD-14A	14" x .125 x 1"		.275"
568827	HSD-14A-20M	14" x .125 x 20mm		.275"
568838	HSD-16A	16" x .138 x 1"		10mm
568810	HSD-12DI-20M	12" x .110 x 20mm	ductile iron	10mm
568830	HSD-14DI-20M	14" x .125 x 20mm		10mm





ALLSTEEL™

Our most versatile grinding wheel

These grinding wheels are designed to deliver top performance when working on both steel and stainless steel. They incorporate the latest developments in grain and bonding technology to lower your grinding costs. Operator safety and comfort, fast removal rates and outstanding life are key features that will let you do more work in less time — guaranteed!

1/8" TYPE 27

Dia.	Thick.	Arbor	Order No.	Grade	Max RPM	Std Pkg.
4 1/2"	1/8"	7/8"	08-C 452	A-30-AS	13,300	25
5"	1/8"	7/8"	08-C 502	A-30-AS	12,200	25
6"	1/8"	7/8"	08-C 602	A-30-AS	10,200	25
7"	1/8"	7/8"	08-C 702	A-30-AS	8,600	25
9"	1/8"	7/8"	08-C 902	A-30-AS	6,800	25

1/4" TYPE 27

Dia.	Thick.	Arbor	Order No.	Grade	Max RPM	Std Pkg.
4 1/2"	1/4"	7/8"	08-C 450	A-24-AS	13,300	10
5"	1/4"	7/8"	08-C 500	A-24-AS	12,200	10
6"	1/4"	7/8"	08-C 600	A-24-AS	10,200	10
7"	1/4"	7/8"	08-C 700	A-24-AS	8,600	10
9"	1/4"	7/8"	08-C 900	A-24-AS	6,800	10

SPIN-ON TYPE 27S

Dia.	Thick.	Arbor	Order No.	Grade	Max RPM	Std. Pkg.
4 1/2"	1/8"	5/8"-11	08-B 452	A-30-COMBO	13,300	25
4 1/2"	1/4"	5/8"-11	08-B 450	A-24-HPS	13,300	10
5"	1/8"	5/8"-11	08-B 502	A-30-COMBO	12,200	25
5"	1/4"	5/8"-11	08-B 500	A-24-HPS	12,200	10

Always use 1/8" wheels with flange 30-B 017 listed on page 67.

Always use 1/4" wheels with flange 30-B 036 listed on page 67.

SPIN-ON TYPE 28S

Dia.	Thick.	Arbor	Order No.	Grade	Max RPM	Std. Pkg.
4 1/2"	1/4"	5/8"-11	08-B 451	A-24-HPS	13,300	10
5"	1/4"	5/8"-11	08-B 501	A-24-HPS	12,200	10

1/8" TYPE 27

Dia.	Thick.	Arbor	Order No.	Grade	Max RPM	Std. Pkg.
3"	1/8"	3/8"	08-B 312	A-24-COMBO	20,000	25
4"	1/8"	3/8"	08-B 412	A-24-COMBO	15,000	25
4"	1/8"	5/8"	08-B 402	A-24-COMBO	15,000	25
4 1/2"	1/8"	7/8"	08-B 462	A-30-COMBO	13,300	25
5"	1/8"	7/8"	08-B 512	A-30-COMBO	12,200	25
6"	1/8"	7/8"	08-B 602	A-30-COMBO	10,200	25
7"	1/8"	7/8"	08-B 712	A-30-COMBO	8,600	25
9"	1/8"	7/8"	08-B 912	A-30-COMBO	6,800	25



CUP WHEELS

Walter cup wheels are widely used for rough grinding or snagging work on concrete or steel. Supplied with deeply anchored wrap-around steel hub for maximum safety and long life. 5/8"-11 threaded arbor for spin-on mounting.

TYPE 11

Dia.	Arbor	Order No.	Max RPM	Std. Pkg.
4"	5/8"-11	12-A 004	9,100	1
5"	5/8"-11	12-A 005	8,600	1
6"	5/8"-11	12-A 006	6,800	1

Dia.	Arbor	Order No.	Max RPM	Std. Pkg.
4"	5/8"-11	12-B 004	9,100	1
5"	5/8"-11	12-B 005	8,600	1
6"	5/8"-11	12-B 006	6,800	1

- ▶ For heavy duty grinding with excellent wheel life

- ▶ For rough grinding on concrete, stone, non-ferrous metals and very hard cast iron. Extremely fast cutting

ZIPCUT™

High performance cutting with angle grinders and circular saws

They cut faster, freer and cooler, requiring less power than standard thin cut-off wheels. They are heavily reinforced for extra safety and yet are very flexible and resilient to resist twisting and bending and will give a true and straight cut every time.

TYPE 1

Dia.	Thickness	Arbor	Order No.	Grade	Max RPM	Std. Pkg.
7"	1/16" (.062")	5/8"	11-T 070	A-30-ZIP	8,600	25
8"	1/16" (.062")	5/8"	11-T 080	A-30-ZIP	7,600	25

TYPE 1

Dia.	Thickness	Arbor	Order No.	Grade	Max RPM	Std. Pkg.
4 1/2"	3/64" (.045")	7/8"	11-T 042	A-60-ZIP	13,300	25
5"	3/64" (.045")	7/8"	11-T 052	A-60-ZIP	12,200	25
6"	3/64" (.045")	7/8"	11-T 062	A-60-ZIP	10,200	25
7"	1/16" (.062")	7/8"	11-T 072	A-30-ZIP	8,600	25
9"*	5/64" (.078")	7/8"	11-T 092	A-30-ZIP	6,800	25

TYPE 27

Dia.	Thickness	Arbor	Order No.	Grade	Max RPM	Std. Pkg.
4 1/2"	3/64" (.045")	7/8"	11-T 142	A-60-ZIP	13,300	25
5"	3/64" (.045")	7/8"	11-T 152	A-60-ZIP	12,200	25
6"	3/64" (.045")	7/8"	11-T 162	A-60-ZIP	10,200	25
7"	1/16" (.062")	7/8"	11-T 172	A-30-ZIP	8,600	25
9"	5/64" (.078")	7/8"	11-T 192	A-30-ZIP	6,800	25



ZIP+™

Superior performance cutting

This new generation of cut-off wheels are specially formulated for the most demanding cutting applications with portable angle grinders. They feature an integrated rib design for better rigidity, cooler cutting and straighter cuts. Used daily by metal fabricators, maintenance departments, sheet metal shops, welding shops, mechanical contractors, equipment manufacturers, automotive shops, etc.



TYPE 1

Dia.	Thickness	Arbor	Order No.	Grade	Max RPM	Std. Pkg.
4 1/2"	1/16" (.062")	7/8"	11-T 242	A-46-ZIP	13,300	25
5"	1/16" (.062")	7/8"	11-T 252	A-46-ZIP	12,200	25

TYPE 27

Dia.	Thickness	Arbor	Order No.	Grade	Max RPM	Std. Pkg.
4 1/2"	1/16" (.062")	7/8"	11-T 453	A-46-ZIP	13,300	25
5"	1/16" (.062")	7/8"	11-T 503	A-46-ZIP	12,200	25
6"	1/16" (.062")	7/8"	11-T 603	A-46-ZIP	10,200	25

► Cut fast, cool and free allowing the operator to work with minimal pressure for best control.

► Equipped with a metal hub cladding for extra strength, control and safety

► The preferred wheel for flush cutting in confined spaces.

PORTACUT™



High speed cutting with gas and electric power saws

These premium wheels stand out as the most reliable cut-off wheels for all on-site cutting jobs. They are specially reinforced for added safety and formulated for an optimal cutting speed and wheel life ratio.



TYPE 1

Dia.	Thick.	Arbor	Order No.	Grade	Max RPM	Std. Pkg.
12"	1/8"	20 mm STIHL	11-A 121	A-24	6,300	10
12"	1/8"	7/8" PARTNER	11-A 122	A-24	6,300	10
12"	1/8"	1"	11-A 123	A-24	6,300	10
14"	1/8"	20 mm STIHL	11-A 141	A-24	5,400	10
14"	1/8"	7/8" PARTNER	11-A 142	A-24	5,400	10
14"	1/8"	1"	11-A 143	A-24	5,400	10

- ▶ General purpose cutting of steel and cast iron



- ▶ Designed for cutting of concrete, concrete blocks, stone, asphalt, etc.
- ▶ General purpose cutting of reinforced concrete pipes, ductile iron, PVC and other plastic pipes

TYPE 1

Dia.	Thick.	Arbor	Order No.	Grade	Max RPM	Std. Pkg.
12"	1/8"	20 mm STIHL	11-D 121	C-24	6,300	10
12"	1/8"	7/8" PARTNER	11-D 122	C-24	6,300	10
12"	1/8"	1"	11-D 123	C-24	6,300	10
14"	1/8"	20 mm STIHL	11-D 141	C-24	5,400	10
14"	1/8"	7/8" PARTNER	11-D 142	C-24	5,400	10
14"	1/8"	1"	11-D 143	C-24	5,400	10



- ▶ The wheel of choice for solids
- ▶ Fast cutting rate with long wheel life

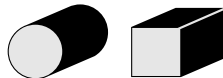

- ▶ The wheel of choice for tubing and extrusions
- ▶ Optimised for use on low power chop saws – reduces load on machine and creates less burr

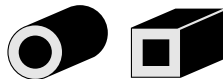

- ▶ Fast and free cutting in all types of aluminum and non-ferrous metals
- ▶ Unique formulation which guarantees no clogging

CHOPCUT™

Performance cutting with portable chop saws

These wheels have been specifically developed for use on portable abrasive chop saws. They put minimum load on the motor and are therefore easy on the operator as well as on the saw.

GENERAL PURPOSE TYPE 1

Dia.	Thick.	Arbor	Order No.	Grade	Max RPM	Std. Pkg.
12"	3/32"	1"	10-Q 123	A-30-HC+	5,200	10
14"	3/32"	1"	10-Q 143	A-30-HC+	4,400	10
16"	7/64"	1"	10-Q 163	A-30-HC+	3,800	10

HIGH PERFORMANCE TYPE 1

Dia.	Thick.	Arbor	Order No.	Grade	Max RPM	Std. Pkg.
12"	3/32"	1"	10-P 123	A-30	5,200	10
14"	3/32"	1"	10-P 143	A-30	4,400	10
16"	7/64"	1"	10-P 163	A-30	3,800	10

ALU TYPE 1

Dia.	Thick.	Arbor	Order No.	Grade	Max RPM	Std. Pkg.
12"	3/32"	1"	10-L 123	A-30-ALU	5,200	10
14"	3/32"	1"	10-L 143	A-30-ALU	4,400	10

BENCH GRINDING WHEELS

- ▶ For general purpose grinding work on bench and pedestal grinders
- ▶ Grits 24 and 36 for fast and rough grinding
- ▶ Grit 46 for intermediate requirements
- ▶ Grits 60 and 80 for a finer finish work
- ▶ All 6", 7", 8" and 10" wheels are supplied with nested reducer bushings to fit on 1", 3/4", 5/8" and 1/2"-shafts



TYPE 1

Dia.	Thickness	Arbor	Order No.	Grade	Max RPM	Std. Pkg.
6"	3/4"	1"	12-E 324	36 coarse	4,100	1
6"	3/4"	1"	12-E 325	46 medium	4,100	1
6"	3/4"	1"	12-E 328	80 fine	4,100	1
6"	1"	1"	12-E 344	36 coarse	4,100	1
6"	1"	1"	12-E 345	46 medium	4,100	1
6"	1"	1"	12-E 348	80 fine	4,100	1
7"	1"	1"	12-E 444	36 coarse	3,600	1
7"	1"	1"	12-E 447	60 fine	3,600	1
7"	1 1/4"	1"	12-E 454	36 coarse	3,600	1
7"	1 1/4"	1"	12-E 457	60 fine	3,600	1
8"	7/8"	1"	12-E 533	24 coarse	3,600	1
8"	7/8"	1"	12-E 537	60 fine	3,600	1
8"	1"	1"	12-E 543	24 coarse	3,600	1
8"	1"	1"	12-E 545	46 medium	3,600	1
8"	1"	1"	12-E 547	60 fine	3,600	1
8"	1 1/4"	1"	12-E 553	24 coarse	3,600	1
8"	1 1/4"	1"	12-E 557	60 fine	3,600	1
10"	1"	1"	12-E 643	24 coarse	2,500	1
10"	1"	1"	12-E 647	60 fine	2,500	1
10"	1 1/4"	1"	12-E 653	24 coarse	2,500	1
10"	1 1/4"	1"	12-E 657	60 fine	2,500	1

TYPE 1

CARBIDE

Dia.	Thickness	Arbor	Order No.	Grade	Max RPM	Std. Pkg.
6"	3/4"	1"	12-E 329	80 fine	4,100	1
7"	1"	1"	12-E 449	80 fine	3,600	1
7"	1 1/4"	1"	12-E 459	80 fine	3,600	1
8"	7/8"	1"	12-E 539	80 fine	3,600	1
8"	1"	1"	12-E 549	80 fine	3,600	1
8"	1 1/4"	1"	12-E 559	80 fine	3,600	1
10"	1"	1"	12-E 649	80 fine	2,500	1



ACCESSORIES

REDUCER BUSHINGS

Order No.

Set 3/4" wide, from 1" to 3/4", 5/8" and 1/2"

12-E 006

Set 1" wide, from 1" to 3/4", 5/8" and 1/2"

12-E 007

Pair of bushings from 1" to 7/8"

12-E 008

WHEEL DRESSERS

Order No.

Standard type

12-E 001

Heavy duty

12-E 002



REPLACEMENT WHEELS

Set for 12-E 001

12-E 004

Set for 12-E 002

12-E 005



Enduro-Flex™ THE ONE STEP FINISHING DISC

Today's Enduro-Flex one-step finishing discs not only meet but surpass the challenges that the metal fabricating and finishing industry faces daily. A new, ultra sharp and refined zirconium grain stays sharper longer to remove more material faster. A special top coat continuously cools and lubricates the disc for smooth, vibration-free grinding and sanding from start to finish.

SPIN-ON



- ▶ Patented backing has now even more reinforcing ribs for added safety
- ▶ Backing can be trimmed down easily for a customized feel

- ▶ Premium J-weight cloth backing for long life and flexibility
- ▶ Perfect for making strip belts for use with the Line-Mate system belt drive roller
- ▶ Ideal for use in maintenance shops, machine shops, manufacturing plants



- ▶ Woven backing is extra tough but tears straight for easy sizing
- ▶ Long life, cool cut



Dia.	Arbor	Grit	Order No.	Max RPM	Std. Pkg.
4 1/2"	5/8"-11	40	06-B 454	13,300	10
4 1/2"	5/8"-11	60	06-B 456	13,300	10
4 1/2"	5/8"-11	80	06-B 458	13,300	10
4 1/2"	5/8"-11	120	06-B 462	13,300	10
5"	5/8"-11	40	06-B 504	12,200	10
5"	5/8"-11	60	06-B 506	12,200	10
5"	5/8"-11	80	06-B 508	12,200	10
5"	5/8"-11	120	06-B 512	12,200	10
6"	5/8"-11	40	06-B 604	10,200	10
6"	5/8"-11	60	06-B 606	10,200	10
6"	5/8"-11	80	06-B 608	10,200	10
6"	5/8"-11	120	06-B 612	10,200	10

Always use with flange 30-B 017

SHOP ROLLS

ALL METALS

Width	Length	Grit	Order No.	Std. Pkg.
1"	50 yards	60	14-C 106	1
1"	50 yards	80	14-C 108	1
1"	50 yards	100	14-C 110	1
1"	50 yards	120	14-C 112	1
1"	50 yards	180	14-C 118	1
1"	50 yards	240	14-C 124	1
1"	50 yards	320	14-C 132	1
1-1/2"	50 yards	60	14-C 206	1
1-1/2"	50 yards	80	14-C 208	1
1-1/2"	50 yards	100	14-C 210	1
1-1/2"	50 yards	120	14-C 212	1
1-1/2"	50 yards	180	14-C 218	1
1-1/2"	50 yards	240	14-C 224	1
1-1/2"	50 yards	320	14-C 232	1
2"	50 yards	60	14-C 306	1
2"	50 yards	80	14-C 308	1
2"	50 yards	100	14-C 310	1
2"	50 yards	120	14-C 312	1
2"	50 yards	180	14-C 318	1
2"	50 yards	240	14-C 324	1
2"	50 yards	320	14-C 332	1

SHEETS

ALL METALS

Dimensions	Grit	Order No.	Std. Pkg.
9" x 11"	40	14-A 904	25
9" x 11"	60	14-A 906	25
9" x 11"	80	14-A 908	25
9" x 11"	100	14-A 910	25
9" x 11"	120	14-A 912	25
9" x 11"	180	14-A 918	25
9" x 11"	240	14-A 924	25
9" x 11"	320	14-A 932	25

Type 1 Chopsaw/Miter Saw Wheels

For Cutting Only

FLEXOVIT

Bench top chopsaws and miter saws offer the advantages of fast, safe, abrasive cutting at a very affordable price. Because of this, these saws can be found at practically every size manufacturing facility and construction site, in production, fabrication or maintenance.

Without a properly designed wheel, the limited horsepower of these machines can hinder performance, reducing wheel and machine life. On the other hand, a well formulated cutoff wheel will deliver more cuts in a wider range of metal types and profiles, without overtaxing the saw. After two decades of development, Flexovit's chopsaw wheel program offers two unsurpassed High Performance metal/stainless specs, as well as two Specialist grades, one for hard materials and larger solids, the other for cutting drywall studs.

Improve performance and lower your 'cost per cut' with Flexovit chopsaw blades.



**HIGH
PERFORMANCE**

- Maximum Productivity
- Exceptional Value
- State-of-the-Art Engineering



S P E C I A L I S T

METAL, STAINLESS

A30RB-Fast Cut

An optimum mix of cutting speed and wheel life make this an excellent 'general purpose' wheel for profiles and solids in carbon or alloy steels.

A30SB-Long Life

Extended wheel life, particularly for lighter gauge cutting in steel and alloys.

C30UB-Heavy Duty

Excellent for cutting tiles, concrete blocks and brick.

Type 1	DIMENSIONS Dia.xThk.xArbor	MAX RPM	METAL, STAINLESS		CONCRETE Heavy Duty	Box Qty.
			Fast Cut	Long Life		
			A30RB	A30SB	C30UB	
	10"x3/32"x5/8"	6,112		F3579		10
	10"x1/8"x5/8"	6,112	F3941		L3818	10
	12"x3/32"x1"	5,092		F4808		10
	12"x3/32"x1"	5,092	F4818			10
	14"x3/32"x1"	4,365	F5521			10
	14"x3/32"x1"	4,365		F5527		10
	16"x3/32"x1"	3,820	F6521			10

S P E C I A L I S T

STAINLESS

A30QB-Free Cut

When cutting stainless or other hard alloys, or for getting through large solids without bogging down in the cut, use this exceptionally fast cutting specification.

DRYWALL STUD

A30TB-Clean Cut

Stands up to the wearing action of sharp metal edges. This wheel cuts more drywall bundles per dollar than any other product.



SPECIALIST®

- Job Focused
- Peak Performance

Type 1

DIMENSIONS Dia.xThk.xArbor	MAX RPM	STAINLESS Free Cut	DRYWALL STUD Clean Cut, Max Life	Box Qty.
		A30QB	A30TB	
12"x3/32"x1"	5,092	F4819		10
14"x3/32"x1"	4,365	F5523		10
14"x3/32"x1"	4,366		F5528	10
16"x5/32"x1"	3,820		F6528	10

Walk-Behind Concrete Saw Wheels

Type 1
For Cutting Only



S P E C - S E L E C T

ASPHALT, GREEN CONCRETE

C16UB-Heavy Duty Extra coarse silicon carbide grain and a tough but free cutting bond make the C16UB an ideal blade for aggressive asphalt and green concrete sawing.

HPC16AG-Extra Heavy Duty An extra heavy duty, high performance blade for asphalt and green concrete sawing. The new HPC16AG is a 'warm pressed' grade. Provides maximum life. Built for 18 to 65 H.P. saws.

ASPHALT, CONCRETE

C16 G.P.-G. Purpose An economical general purpose wheel for asphalt and concrete.

CURED CONCRETE

C20SB-Heavy Duty Fast cutting on cured concrete, the C20SB works well regardless of aggregate.

C16TB For use on high horsepower saws (35HP and up), C16TB is excellent for cured concrete cutting and joint widening.



HIGH PERFORMANCE

- Maximum Productivity
- Exceptional Value
- State-of-the-Art Engineering

DIMENSIONS Dia.xThk.xArbor	MAX RPM	ASPHALT, GREEN CONCRETE		CURED CONCRETE		Box Qty.	
		General Purpose	Heavy Duty	Extra Heavy Duty	Heavy Duty		Heavy Duty
		C16 G.P.	C16UB (-T*)	HPC16AG	C20SB (-T*)		C16TB (-T*)
12"x5/32"x1"(D-1)	5,095				L5319		10
	5,092		L5339				10
14"x3/16"x1"(D-1)	4,365				L5902		10
		L5910					10
				L6020			10
			L6017			L6051	10
14"x1/4"x1"(D-1)	4,365				L6320 *		10
				L6329			10
			L6327		L6321	L6330	10
14"x3/8"x1"(D-1)	4,365		L6445 *		L6440 *	L6550 *	5
				L6447			5
							5
18"x3/16"x1"(D-1)	3,015		L8081		L8083		10
18"x1/4"x1"(D-1)	3,015				L8321		10
				L8082			5
18"x3/8"x1"(D-1)	3,015			L8350			5

* Indicates 14" wheels with 3 layers of fiberglass reinforcements.
(D-1) indicates single drive pinhole.



HIGH PERFORMANCE

- Maximum Productivity
- Exceptional Value
- State-of-the-Art Engineering

Masonry Saw Wheels

Type 1
For Cutting Only



S P E C - S E L E C T

BRICK, BLOCK

C24SB-Long Life A long life wheel for common brick, light aggregate cement block and fireclay.

C24RB-G. Purpose A general purpose wheel for concrete masonry products - brick and block.

C20TB-Soft Material For light weight cinder and concrete block.

FLEXOVIT

DIMENSIONS Dia.xThk.xArbor	MAX RPM	BRICK, BLOCK			Box Qty.
		Long Life	Soft Material	General Purpose	
		C24SB	C20TB	C24RB	
14"x1/8"x1"	4,365	L5907	L5586	L5927	10
18"x1/8"x1"	3,015	L7776			10
20"x1/8"x1"	2,710	L8951			10



Type 1 High Speed Gas & Electric Saw Wheels

For Cutting Only



**HIGH
PERFORMANCE**

- Maximum Productivity
- Exceptional Value
- State-of-the-Art Engineering



S P E C I A L I S T

STEEL

A24/30SB-Heavy Duty A durable, hard working blade for a variety of metal cutting applications on the job site. Excellent for rebar, steel pipe, sheet metal and structural steel or stainless.

CONCRETE

C30UB-Heavy Duty The contractors' choice for all-around performance when cutting concrete and masonry products, including brick, block and pipe. Also cuts PVC and ductile iron pipe (for best results on ductile, see Specialist AC24SB-Ductile, Cast Iron, listed below).

FLEXOVIT

Type 1	DIMENSIONS Dia.xThk.xArbor	MAX RPM	STEEL	CONCRETE	Box Qty.
			Heavy Duty		
			A24/30SB	C30UB	
	12"x1/8"x20mm	6,300	F5078	L5315	10
	12"x1/8"x7/8"	6,300	F5286	L5316	10
	12"x1/8"x1"	6,300	F5292	L5317	10
	14"x1/8"x20mm	5,460	F5653	L5703	10
	14"x1/8"x7/8"	5,400	F5650	L5708	10
	14"x1/8"x1"	5,400	F5687	L5727	10

S P E C I A L I S T

SHEET METAL, DECKING

A24TB-Long Life Built to withstand the wear of sharp metal edges, this blade stands up to sheet metal, roof decking and auto dismantling jobs.

RAILTRACK

A30PB-Extra Fast Cut Designed for rail cropping. Straight, fast cuts on all sizes and weights of rail.

DUCTILE, CAST IRON

AC24SB-Heavy Duty For sewer and water construction and maintenance. Cuts ductile iron, cast iron and concrete lined pipe.

ASPHALT, GREEN CONCRETE

C16UB-Long Life Made of extra coarse silicon carbide, C16UB provides aggressive free cutting action, in a wide range of aggregates.

PRESTRESSED CONCRETE

C30SB-Heavy Duty Designed for extra fast cutting in prestressed concrete.



SPECIALIST®

- Job Focused
- Peak Performance

DIMENSIONS Dia.xThk.xArbor	MAX RPM	SHEET METAL DECKING	RAIL TRACK	DUCTILE CAST IRON	ASPHALT GR. CONCRETE	PRESTRESSED CONCRETE	Box Qty.
		Long Life	Extra Fast Cut	Heavy Duty	Long Life	Heavy Duty	
		A24TB	A30PB	AC24SB	C16UB	C30SB	
12"x1/8"x20mm	6,300			L5017			10
12"x1/8"x7/8"	6,300			L5018		L5310	10
12"x1/8"x1"	6,300		F5098	L5019		L5312	10
12"x5/32"x20mm	6,300	F5293					10
12"x5/32"x7/8"	6,300	F5299			L5330		10
12"x5/32"x1"	6,300	F5314			L5332		10
14"x1/8"x20mm	5,460			L5617	L5334		10
14"x1/8"x7/8"	5,400			L5618			10
14"x1/8"x1"	5,400		F5681	L5619			10
14"x5/32"x20mm	5,460	F5693					10
14"x5/32"x1"	5,400	F5614			L5710		10
16"x1/8"x1"	4,500		F6681		L5712		10



S P E C I A L E C T

CARBON WIRE

.014-.035

For general purpose cleaning and deburring.

STAINLESS WIRE

.014-.020

Ideal for applications on aluminum, stainless steel and high strength alloys, and other applications. All Flexovit stainless steel brushes are made with 302 stainless.

Crimped Wire Cups

For light cleaning and paint removal. Ideal for flat surfaces and edge cleaning.



DIMENSIONS Dia.xThread	MAX RPM	CARBON		STAINLESS	Box/ Crt. Qty.
		.014	.020	.014	
2-3/4"x5/8-11	12,500	C1690			1/6
				C1740	1/6
2-3/4"xM14-2.0	12,500	C1700			1/6
				C1745	1/6
2-3/4"xM10-1.25	12,500	C1710			1/6
				C1750	1/6
2-3/4"xM10-1.5	12,500	C1720			1/6
				C1755	1/6
2-3/4"x1/2-13	12,500	C1730			1/6
				C1760	1/6
3-1/2"x5/8-11	12,500	C1695			1/6
				C1697	1/6
4"x5/8-11	8,000		C1800		1/6
5"x5/8-11	7,000		C1810		1/6
6"x5/8-11	6,600		C1830		1/6

Knotted Wire Cups

For high impact, heavy duty cleaning or rough scale removal. Knock-off bridles on select sizes restrain the knots from flaring out and preventing premature wire breakage.

The bridle can be removed as the brush wears down, exposing new wire.



DIMENSIONS Dia.xThread	MAX RPM	CARBON			STAINLESS	Box Crt. Qty.
		.014	.020	.035	.020	
2-3/4"x5/8-11	12,500		C1480			1/6
		C1575				1/6
2-3/4"xM14-2.0	12,500		C1490		C1580	1/6
					C1590	1/6
2-3/4"xM10-1.25	12,500		C1500			1/6
					C1600	1/6
2-3/4"xM10-1.5	12,500		C1510			1/6
					C1610	1/6
2-3/4"x1/2-13	12,500		C1520			1/6
					C1620	1/6
3-1/2"x5/8-11	12,500	C1483				1/6
			C1485			1/6
					C1585	1/6
4"x5/8-11	7,000		C1630			1/6
4"x5/8-11, Knock-Off Bridle	8,500		C1632			1/6
5"x5/8-11, Knock-Off Bridle	8,500		C1637			1/6
					C1638	1/6
6"x5/8-11	6,600		C1640			1/6
				C1650		1/6
6"x5/8-11, 2 Rows	6,000				C1660	1/6
			C1670			1/6
6"x5/8-11, Knock-Off Bridle	6,500			C1680		1/6
			C1642			1/6

DIMENSIONS Pad ThreadxMachine Thread	THREADED INSERT ADAPTOR	Box Qty.
5/8"-11 to M10-1.25	SK0125	1
5/8"-11 to M10-1.5	SK0150	1
5/8"-11 to 3/8"-24	SK0324	1

Reusable inserts convert common 5/8"-11 threaded arbor to metric or 3/8"-24 thread.













Carbide Burs

For Grinding

FLEXOVIT

Designed for fast material removal on most metals, Flexovit carbide burs have precision ground tungsten carbide tips, silver brazed to a 1/4" diameter hardened steel shank. The "double cut" construction, with its chisel tooth cutting pattern, produces small granular chips instead of long sliver chips, eliminating loading of the flutes and minimizing chatter.

Carbide burs are ideal for shaping and enlarging holes in steel, removing welds and smoothing castings. They are an excellent alternative to mounted points in hard-to-reach or confined areas. For aluminum, fiberglass, plastics and nonferrous metal, select an aluminum cut bur with a coarse pitch flute style for easy chip flow with no loading and extremely fast stock removal.

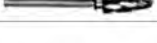
PROFILE	DIMENSIONS Dia.xLengthxShank	SHAPE	U.S.C.T.I. NUMBER	PRODUCT CODE	Box Qty.
DOUBLE CUT SERIES FOR STEEL AND STAINLESS WITH 1/4" SHANK					
	1/4"x5/8"x1/4" SHANK	CYLINDER	SA-1	VA15M2	1
	3/8"x3/4"x1/4" SHANK	CYLINDER	SA-3	VA18O2	1
	1/2"x1"x1/4" SHANK	CYLINDER	SA-5	VA20R2	1
	1/4"x5/8"x1/4" SHANK	BALL NOSE CYLINDER	SC-1	VC15M2	1
	3/8"x3/4"x1/4" SHANK	BALL NOSE CYLINDER	SC-3	VC18O2	1
	1/2"x1"x1/4" SHANK	BALL NOSE CYLINDER	SC-5	VC20R2	1
	1/4"x3/16"x1/4" SHANK	BALL	SD-1	VD15D2	1
	3/8"x5/16"x1/4" SHANK	BALL	SD-3	VD18G2	1
	1/2"x7/16"x1/4" SHANK	BALL	SD-5	VD20J2	1
	1/4"x3/8"x1/4" SHANK	OVAL	SE-1	VE15I2	1
	3/8"x5/8"x1/4" SHANK	OVAL	SE-3	VE18M2	1
	1/2"x7/8"x1/4" SHANK	OVAL	SE-5	VE20P2	1
	1/4"x5/8"x1/4" SHANK	ROUND NOSE TREE	SF-1	VF15M2	1
	3/8"x3/4"x1/4" SHANK	ROUND NOSE TREE	SF-3	VF18O2	1
	1/2"x1"x1/4" SHANK	ROUND NOSE TREE	SF-5	VF20R2	1
	1/4"x5/8"x1/4" SHANK	POINTED TREE	SG-1	VG15M2	1
	3/8"x3/4"x1/4" SHANK	POINTED TREE	SG-3	VG18O2	1
	1/2"x1"x1/4" SHANK	POINTED TREE	SG-5	VG20R2	1
	1/4"x5/8"x1/4" SHANK	BALL NOSE CONE	SL-1	VL15M2	1
	3/8"x1-1/16"x1/4" SHANK	BALL NOSE CONE	SL-3	VL18S2	1
	1/2"x1-1/8"x1/4" SHANK	BALL NOSE CONE	SL-4	VL20T2	1
	1/4"x1/2"x1/4" SHANK	POINTED CONE	SM-1	VM15K2	1
	3/8"x5/8"x1/4" SHANK	POINTED CONE	SM-4	VM18M2	1
	1/2"x7/8"x1/4" SHANK	POINTED CONE	SM-5	VM20P2	1
FOR ALUMINIUM AND NONFERROUS WITH 1/4" SHANK					
	3/8"x3/4"x1/4" SHANK	CYLINDER	SA-3NF	VA18O5	1
	1/2"x1"x1/4" SHANK	CYLINDER	SA-5NF	VA20R5	1
	3/8"x3/4"x1/4" SHANK	BALL NOSE CYLINDER	SC-3NF	VC18O5	1
	1/2"x1"x1/4" SHANK	BALL NOSE CYLINDER	SC-5NF	VC20R5	1
	3/8"x5/16"x1/4" SHANK	BALL	SD-3NF	VD18I5	1
	1/2"x7/16"x1/4" SHANK	BALL	SD-5NF	VD20K5	1
	3/8"x3/4"x1/4" SHANK	ROUND NOSE TREE	SF-3NF	VF18O5	1
	1/2"x1"x1/4" SHANK	ROUND NOSE TREE	SF-5NF	VF20R5	1

Hand Scratch Wire Brushes

For Cleaning & Conditioning

Constructed of high quality, stiff black horsehair and tin shafts, Flexovit's acid swab brushes hold up to the application demands of acid solder, gunk, lubricants, and adhesives.



BRUSH TYPE	DIMENSIONS	Wire Size & Material	HAND BRUSH	Box Qty.
	WidthxLength			
ACID SWAB BRUSH	3/8"x3/4" TRIM	HORSEHAIR	C1920	144
	1/2"x7/8" TRIM	HORSEHAIR	C1930	144
	5/8"x7/8" TRIM	HORSEHAIR	C1940	144
SCRATCH BRUSH	3x19 ROWS, CURVED HANDLE	.014 CARBON	C1950	12
	4x19 ROWS, CURVED HANDLE	.014 CARBON	C1960	12
	3x19 ROWS, CURVED HANDLE	.012 STAINLESS	C1970	12
	3x19 ROWS, CURVED HANDLE, W/ SCRAPER	.014 CARBON	C1980	12
	4x16 ROWS, SHOE HANDLE	.014 CARBON	C1990	12
	4x16 ROWS, SHOE HANDLE	.012 STAINLESS	C2000	12
	3x7 ROWS, CURVED HANDLE	.006 STAINLESS	C2010	12
WELDER'S TOOTH BRUSH	3x7 ROWS, LACE BACK, CURVED HANDLE	.006 STAINLESS	C2020	12
CHIPPING HAMMER	3X15 ROWS	.014 CARBON	C2060	12

DIES • TAPS • HANDLES

FRACTIONAL ROUND DIES

RD SERIES NC or NF



FRACTIONAL HAND TAPS TAPER PLUG BOTTOMING



ROUND DIES TAPS

THREAD SIZE	T.P.I.	
	N.S.	N.S.
4	32	36
6	36	48
8	40	—
10	30	—
12	32	—
14	20	24

MACHINE SCREW TAPS

4	32	36 •
5	36	—
6	—	36
6	48	—
8	—	40
10	30	40
12	32	—
14	20	24

PIPE TAPS



1/8	27	—
1/4	18	—
3/8	18	—
1/2	14	—
3/4	14	—
1	11.1/2	—
1.1/8	—	8
1.1/4	11.1/2	8
1.3/8	—	8
1.1/2	11.1/2	8

ROUND DIE STOCK HANDLES



DS-1	13/16
DS-2	1
DS-3	1.5/16
DS-4	1.1/2
DS-5	2

ADJUSTABLE TAP WRENCHES



TW3	1/8 - 1/2
TW4	1/4 - 3/4
TW5	1/2 - 1
TW6	3/4 - 1.1/2
TW7	1 - 2.1/2

"T" TAP HANDLE



NO	DESCRIPTION
T10	1/18" to 3/16" Tap Capacity

HEAVY DUTY "T" TAP HANDLE



NO	DESCRIPTION
T40	1/4" to 1/2" Tap Capacity

HEXAGON-RETHREADING DIES



NF OR NC THREAD

1/4	20	28
5/16	18	24
3/8	16	24
7/16	14	20
1/2	13	20
9/16	12	18
5/8	11	18
3/4	10	16
7/8	9	14
1	8	12
1.1/8	7	12
1.1/4	7	12
1.3/8	6	12
1.1/2	6	12
1.3/4	5	—
2	4.1/2	—

UNIBIT®



Style #	Number of Holes	Hole Sizes	Increments	Shank Size	Max. Material Thickness	Carded Stock #
1	13	1/8" - 1/2"	1/32"	1/4"	1/8"	10231
2	6	3/16" - 1/2"	1/16"	1/4"	3/8"	10232
3	9	1/4" - 3/4"	1/16"	3/8"	1/8"	10233
4	12	3/16" - 7/8"	1/16"	3/8"	1/8"	10234
5	10	1/4" - 1-3/8"	1/8"	1/2"	1/8"	10235
9	2	7/8" and 1-1/8" (1/2" and 3/4" KO)	-	1/2"	1/8"	10239

BI-METAL RECIPROCATATING BLADES



ALL PURPOSE RECIPROCATATING BLADES



PART NUMBER	BLADE LENGTH	TEETH PER INCH	DESCRIPTION	WIDTH / LENGTH	STANDARD PACK QTY.
RB636W	6"	6T	Wood & Nail Slope	3/4" x 6" x .050	5
RB656WS	6"	6T	Wood & Nail Scroll	3/4" x 6" x .050	5
RB956W	9"	6T	Wood & Nail	3/4" x 9" x .050	5
RB125W	12"	6T	Wood & Nail	3/4" x 12" x .050	5
RB414M	4"	14T	Short Metal Cutting	5/8" x 4" x .035	5
RB418M	4"	18T	Short Metal Cutting	5/8" x 4" x .035	5
RB424M	4"	24T	Short Metal Cutting	5/8" x 4" x .035	5
RB610HDM	6"	10T	HD Metal Cutting	3/4" x 6" x .035	5
RB614HDM	6"	14T	HD Metal Cutting	3/4" x 6" x .035	5
RB618HDM	6"	18T	HD Metal Cutting	3/4" x 6" x .035	5
RB624HDM	6"	24T	HD Metal Cutting	3/4" x 6" x .035	5
RB810HDM	8"	10T	HD Metal Cutting 10/14 V.P.	3/4" x 8" x .035	5
RB814HDM	8"	14T	HD Metal Cutting	3/4" x 8" x .035	5
RB818HDM	8"	18T	HD Metal Cutting	3/4" x 8" x .036	5
RB1218HDM	12"	18T	HD Metal Cutting	3/4" x 12" x .035	5
RB636DW	6"	6"	Drywall V Head	3/4" x 6" x .035	5
RBCCRF	8"	CARBIDE GRIT	Cast Iron-Ceramic Tile	3/4" x 8" x .050	1



Jig Saw Blades

● European style

For Metabo, AEG, Bosch, Elu, Hitachi, Holz Her, Makita 4304, 4304T, 4305T, 4323 & 4324, Dewalt 313, 318K, 321, 321K & 323K, Milwaukee 6266-6, 6267-20 & 6276-6, Porter Cable 9543 and Walter jig saws.

● Universal style

For Black & Decker, Craftsman, Hitachi, Millers Falls, Makita 4304, 4304T, 4305, 4305T, Milwaukee, Ryobi, Shopmate, Skil, Wen, Porter Cable 97549 and Dewalt 313, 318K, 321, 321K & 323K jig saws.

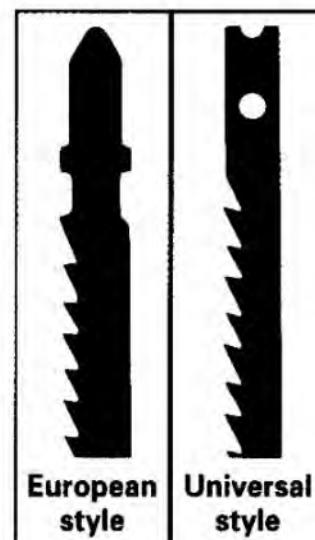

TAURUS REGULAR

Hard nylon two piece sleeve, metal nose cap, suitable for machines in forward and reverse mode. Hand tightening style.



Model No.	Drilling capacity mm	Mount	A mm	B mm	C mm	Max machine rating	Packaging style	Weight g
LD10F12R	1.5-10	1/2" x 20	42.7	55	62	Suitable for machines in forward and reverse mode only	Individual box	180
LD10F12RB							Blister card	
LD10F38R		3/8" x 24					Individual box	
LD10F38RB							Blister card	
LDPL13F12R	2-13	1/2" x 20	42.7	56	72	Suitable for machines in forward, reverse and percussion mode up to 450 W	Individual box	195
LDPL13F12RB							Blister card	
LDPL13F38R		3/8" x 24					Individual box	
LDPL13F38RB							Blister card	

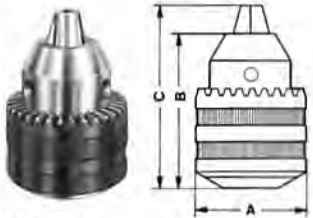

Key operated chucks

Medium duty for professional users of power tools, bench drilling machines, and woodworking machinery.
Heavy duty for production drilling machines and industrial power tools.



Morse taper arbors with taper and threaded mounts, precision ground, hardened and tempered

TAURUS SUPER

Two piece full metal sleeve suitable for forward, reverse and impact mode. Standard jaws with serrated bite.



Model No.	Drilling capacity mm	Mount	A mm	B mm	C mm	Max machine rating	Packaging style	Weight g
TS13F12R	1.5-13	1/2" x 20	42.7	64	75.3	1100 W	Individual box	295
TS13F12RB							Blister card	
TS13SDS		SDS					Individual box	

TAURUS SUPER - SPINDLE LOCK SYSTEM

For machines with Spindle Lock system. Full metal single sleeve suitable for forward, reverse and impact mode. Standard jaws with serrated bite.



Model No.	Drilling capacity mm	Mount	A mm	B mm	C mm	Max machine rating	Packaging style	Weight g
TSS13F12R	1.5-13	1/2" x 20	42.7	64	75.3	1100 W	Individual box	295
TSS13F12RB							Blister card	

TAURUS ULTIMATE

Two piece full metal sleeve suitable for forward, reverse and impact mode. Carbide tipped jaws.



Model No.	Drilling capacity mm	Mount	A mm	B mm	C mm	Max machine rating	Packaging style	Weight g
TU13F12R	1.5-13	1/2" x 20	42.7	64	75.3	1100 W	Individual box	295
TU13F12RB							Blister card	

SST+™ HIGH PERFORMANCE

FRACTIONAL SIZES

Drill Size	Flute Length	Overall Length	Order No.	Min. Pkg.
1/64"	3/16"	13/16"	01-A 501	10
1/32"	3/8"	1 3/16"	01-A 502	10
3/64"	5/8"	1 1/2"	01-A 503	10
1/16"	13/16"	1 11/16"	01-A 504	10
5/64"	15/16"	1 15/16"	01-A 505	10
3/32"	1 3/16"	2 1/4"	01-A 506	10
7/64"	1 5/16"	2 3/8"	01-A 507	10
1/8"	1 7/16"	2 9/16"	01-A 508	10
9/64"	1 9/16"	2 3/4"	01-A 509	10
5/32"	1 11/16"	2 15/16"	01-A 510	10
11/64"	1 7/8"	3 1/8"	01-A 511	10
3/16"	2 1/16"	3 3/8"	01-A 512	10
13/64"	2 1/16"	3 3/8"	01-A 513	10
7/32"	2 1/4"	3 11/16"	01-A 514	10
15/64"	2 1/4"	3 11/16"	01-A 515	10

Packaged in reclosable plastic boxes.

Sizes 3/64" and smaller have a regular point.



SST+™ PRENTICE DRILL BITS

1/2" shank



FRACTIONAL SIZES

Drill Size	Flute Length	Overall Length	Order No.	Min. Pkg.
33/64"	3 1/8"	6"	01-M 533	1
17/32"	3 1/8"	6"	01-M 534	1
35/64"	3 1/8"	6"	01-M 535	1
9/16"	3 1/8"	6"	01-M 536	1
37/64"	3 1/8"	6"	01-M 537	1
19/32"	3 1/8"	6"	01-M 538	1
39/64"	3 1/8"	6"	01-M 539	1
5/8"	3 1/8"	6"	01-M 540	1
41/64"	3 1/8"	6"	01-M 541	1
21/32"	3 1/8"	6"	01-M 542	1
43/64"	3 1/8"	6"	01-M 543	1
11/16"	3 1/8"	6"	01-M 544	1
45/64"	3 1/8"	6"	01-M 545	1
23/32"	3 1/8"	6"	01-M 546	1
47/64"	3 1/8"	6"	01-M 547	1
3/4"	3 1/8"	6"	01-M 548	1
25/32"	3 1/8"	6"	01-M 550	1
13/16"	3 1/8"	6"	01-M 552	1
27/32"	3 1/8"	6"	01-M 554	1
7/8"	3 1/8"	6"	01-M 556	1
29/32"	3 1/8"	6"	01-M 558	1
15/16"	3 1/8"	6"	01-M 560	1
31/32"	3 1/8"	6"	01-M 562	1
1"	3 1/8"	6"	01-M 600	1
1 1/16"	3 1/8"	6"	01-M 604	1
1 1/8"	3 1/8"	6"	01-M 608	1
1 3/16"	3 1/8"	6"	01-M 612	1
1 1/4"	3 1/8"	6"	01-M 616	1

Individually packaged in reclosable plastic boxes.



Drill Size	Flute Length	Overall Length	Order No.	Min. Pkg.
1/4"	2 1/2"	4"	01-A 516	10
17/64"	2 11/16"	4 5/16"	01-A 517	10
9/32"	2 11/16"	4 5/16"	01-A 518	10
19/64"	2 15/16"	4 5/8"	01-A 519	10
5/16"	2 15/16"	4 5/8"	01-A 520	10
21/64"	2 15/16"	4 5/8"	01-A 521	10
11/32"	3 3/16"	4 15/16"	01-A 522	10
23/64"	3 3/16"	4 15/16"	01-A 523	10
3/8"	3 7/16"	5 1/4"	01-A 524	10
25/64"	3 7/16"	5 1/4"	01-A 525	5
13/32"	3 7/16"	5 1/4"	01-A 526	5
27/64"	3 11/16"	5 9/16"	01-A 527	5
7/16"	3 11/16"	5 9/16"	01-A 528	5
29/64"	3 11/16"	5 9/16"	01-A 529	5
15/32"	4"	5 15/16"	01-A 530	5
31/64"	4"	5 15/16"	01-A 531	5
1/2"	4"	5 15/16"	01-A 532	5

SST+™ QUICK SHANK HIGH PERFORMANCE HSS DRILL BITS

Jobber's Length

The proven original SST+ drill bit is now available featuring an exclusive Quick Shank that ensures fast and secure tightening inside any keyed or keyless chuck. Ideal for cordless drills, allowing you to drill more holes per charge. Recommended for drilling aluminum, non-ferrous metals and thin gauge metal, where a jobber's length bit is required.



FRACTIONAL SIZES

Drill Size	Flute Length	Overall Length	Order No.	Min. Pkg.
1/16"	3/16"	13/16"	01-A 004	10
5/64"	15/16"	1 15/16"	01-A 005	10
3/32"	1 3/16"	2 1/4"	01-A 006	10
7/64"	1 5/16"	2 3/8"	01-A 007	10
1/8"	1 7/16"	2 9/16"	01-A 008	10
9/64"	1 9/16"	2 3/4"	01-A 009	10
5/32"	1 11/16"	2 15/16"	01-A 010	10
11/64"	1 7/8"	3 1/8"	01-A 011	10
3/16"	2 1/16"	3 3/8"	01-A 012	10
13/64"	2 1/16"	3 3/8"	01-A 013	10
7/32"	2 1/4"	3 11/16"	01-A 014	10
15/64"	2 1/4"	3 11/16"	01-A 015	10
1/4"	2 1/2"	4"	01-A 016	10
17/64"	2 11/16"	4 5/16"	01-A 017	10
9/32"	2 11/16"	4 5/16"	01-A 018	10
19/64"	2 15/16"	4 5/8"	01-A 019	10
5/16"	2 15/16"	4 5/8"	01-A 020	10
21/64"	2 15/16"	4 5/8"	01-A 021	10
11/32"	3 3/16"	4 15/16"	01-A 022	10
23/64"	3 3/16"	4 15/16"	01-A 023	10
3/8"	3 7/16"	5 1/4"	01-A 024	10
25/64"	3 7/16"	5 1/4"	01-A 025	5
13/32"	3 7/16"	5 1/4"	01-A 026	5
27/64"	3 11/16"	5 9/16"	01-A 027	5
7/16"	3 11/16"	5 9/16"	01-A 028	5
29/64"	3 11/16"	5 9/16"	01-A 029	5
15/32"	4"	5 15/16"	01-A 030	5
31/64"	4"	5 15/16"	01-A 031	5
1/2"	4"	5 15/16"	01-A 032	5

Packaged in reclosable plastic boxes

Sizes 11/64" and smaller have a round shank



JOBBER LENGTH DRILLS



135°
SPLIT POINT

SUPERBA HEAVY DUTY DRILLS SUPER HSS

SERIES 206US FRACTIONAL SIZES

PART NUMBER	DRILL SIZE	DEC. EQUIV.	O/A LENGTH	FLUTE LENGTH
206US0464	1/16"	.0625	1-7/8"	7/8"
206US0564	5/64"	.0781	2"	1"
206US0664	3/32"	.0938	2-1/4"	1-1/4"
206US0764	7/64"	.1094	2-5/8"	1-1/2"
206US0864	1/8"	.1250	2-3/4"	1-5/8"
206US0964	9/64"	.1406	2-7/8"	1-3/4"
206US1064	5/32"	.1562	3-1/8"	2"
206US1164	11/64"	.1719	3-1/4"	2-1/8"
206US1264	3/16"	.1875	3-1/2"	2-5/16"
206US1364	13/64"	.2031	3-5/8"	2-7/16"
206US1464	7/32"	.2188	3-3/4"	2-1/2"
206US1564	15/64"	.2344	3-7/8"	2-5/8"
206US1664	1/4"	.2500	4"	2-3/4"
206US1764	17/64"	.2656	4-1/8"	2-7/8"
206US1864	9/32"	.2812	4-1/4"	2-15/16"

BLACK OXIDE & GOLD FINISH

PART NUMBER	DRILL SIZE	DEC. EQUIV.	O/A LENGTH	FLUTE LENGTH
206US1964	19/64"	.2969	4-3/8"	3-1/16"
206US2064	5/16"	.3125	4-1/2"	3-3/16"
206US2164	21/64"	.3281	4-5/8"	3-5/16"
206US2264	11/32"	.3438	4-3/4"	3-7/16"
206US2364	23/64"	.3594	4-7/8"	3-1/2"
206US2464	3/8"	.3750	5"	3-5/8"
206US2564	25/64"	.3906	5-1/8"	3-3/4"
206US2664	13/32"	.4062	5-1/4"	3-7/8"
206US2764	27/64"	.4219	5-3/8"	3-15/16"
206US2864	7/16"	.4375	5-1/2"	4-1/16"
206US2964	29/64"	.4531	5-5/8"	4-3/16"
206US3064	15/32"	.4688	5-3/4"	4-5/16"
206US3164	31/64"	.4844	5-7/8"	4-3/8"
206US3264	1/2"	.5000	6"	4-1/2"



29 Pc. Jobber Set



1/2" SHANK 6" LONG SUPERBA SILVER & DEMING HEAVY DUTY

SERIES 201US

113°
SPLIT POINT

BLACK OXIDE & GOLD FINISH

PART NUMBER	DRILL SIZE	DEC. EQUIV.	O/A LENGTH	FLUTE LENGTH
201US3464	17/32"	.5312	6"	2-3/4"
201US3664	9/16"	.5625	6"	2-3/4"
201US3864	19/32"	.5938	6"	2-3/4"
201US4064	5/8"	.6250	6"	2-3/4"
201US4264	21/32"	.6562	6"	2-3/4"
201US4464	11/16"	.6875	6"	2-3/4"
201US4664	23/32"	.7188	6"	2-3/4"
201US4864	3/4"	.7500	6"	2-3/4"

PART NUMBER	DRILL SIZE	DEC. EQUIV.	O/A LENGTH	FLUTE LENGTH
201US5064	25/32"	.7812	6"	2-3/4"
201US5264	13/16"	.8125	6"	2-3/4"
201US5464	27/32"	.8438	6"	2-3/4"
201US5664	7/8"	.8750	6"	2-3/4"
201US5864	29/32"	.9062	6"	2-3/4"
201US6064	15/16"	.9375	6"	2-3/4"
201US6264	31/32"	.9688	6"	2-3/4"
201US6464	1"	1.0000	6"	2-3/4"



8 Pc. S&D Set

IRWIN 65T- WOOD BITS 1/4" TO 1 1/2" X 18" LONG



FLAT WOOD BITS - 1/4" TO 1 1/2"





No. 524

3/8" DRILL
VARIABLE SPEEDS
0-2600 RPM
REVERSIBLE
4.2 AMP.
WEIGHT: 3.3LBS



No. BE 532S R+L

Rated input [watts]: 520
Chuck capacity [mm]: 1.5-13
Electronics: V
Gears: 1



No. BST 18 PLUS

Num. battery packs: 2
Charger: IC 25
Voltage/Capacity of battery pack [volt/Ah]: 18 / 2.4
Carrying case: x



No. H 1600
No. HE 2000

Rated input [watts]: 1600
Air temperature [°C]: 50/350/550
Air-flow rates: 3

Rated input [watts]: 2000
Air temperature [°C]: 50-600
Air-flow rates: 3



No. STE 70

Rated input [watts]: 570
Material thickness in timber [mm]: 70
Orbital saw-blade movement: 4-level
Electronics: VC



No. W7-125

Compact range
Rated input [watts]: 750
Speed [rpm]: 10 000
Disc diameter [mm]: 125



No. KHE 24

Rated input [watts]: 750
Single-blow energy [joules]: 0-2.3
Electronics: VTC
Percussion stop: x
Carrying case: x



No. KHE32

Rated input [watts]: 900
Single-blow energy [joules]: 0-3.5
Electronics: VTC
Percussion stop: x
Carrying case: x

multi-fit™ Universal Concrete Bit System

Using the best concrete bits available is the key to take full advantage of today's hard hitting rotary hammers. Only these bits will maintain high performances over a long period of time. Multi-fit is an advanced, easy to use concrete bit system for drilling holes up to 5" diameter. It covers the full range of applications with most rotary hammers available today – to ensure that the job is always done quickly and at the lowest cost.

KING DRILL PRESSES

8" BENCH MOUNT DRILL PRESS

- Switch located at front of machine for easy access
- Spindle supported by high quality bearings
- 45° tilting table for angular drilling
- Positive depth stop for quick and easy adjustment



13" AND 15" DRILL PRESSES

- Built-in work light
- Comes with non-slip rubber handles
- 45° tilting table for angular drilling
- Locking depth stop for accurate, repetitive blind hole drilling
- On / Off power switch located at front of machine for easy access



Model No.	Size"	Type	Chuck"	Speeds	Table Size"	Spindle Taper	Motor Amps	Volts/Hz/Phase	Wt. lbs.
KC-108C	8	Bench	1/2	5	6 1/2 x 6 1/2	Jacobs #3	2.5	110V / 60Hz / 1	42
KC-116C	13	Bench	5/8	16	12 13/16 dia.	Morse #2	7.5	110V / 60Hz / 1	125
KC-116FC	13	Floor	5/8	16	12 13/16 dia.	Morse #2	7.5	110V / 60Hz / 1	147
KC-117C	15	Bench	5/8	16	13 5/8 dia.	Morse #2	10.5	110V / 60Hz / 1	143
KC-117FC	15	Floor	5/8	16	13 5/8 dia.	Morse #2	10.5	110V / 60Hz / 1	157

BENCH GRINDERS

- Direct drive motors with no brushes or belts to adjust or replace
- Permanently lubricated motor bearings
- Adjustable, shatter resistant eyeshields
- Removable wheel covers for easier wheel changes
- Comes complete with adjustable tool rests and medium and coarse grinding wheels



	Wheel Size "	Motor Amps	RPM	Voltage	Wt. lbs.
KC-580	5 x 1/2	2	3500	110 V, 1 Ph	12
KC-690	6 x 3/4	3.5	3500	110 V, 1 Ph	18
KC-690L	6 x 3/4	3.5	3500	110 V, 1 Ph	19
KC-880	8 x 3/4	7	3450	110 V, 1 Ph	36
KC-1080	10 x 1	14	1725	110 V, 1 Ph	70

10" CONTRACTOR BENCH SAWS

Rip fence, full cast iron table and extension wings, mitre gauge with t-slot and metal stand are included with all these saws.

Model No.:	KC-10SC	KC-10RC
Blade Size:	10"	10"
Arbor:	5/8"	5/8"
Motor:	1 HP, 110 V	2 HP, 110/220 V
Depth of cut @ 45°/90°:	1 3/4" / 2 1/4"	2 1/8" / 3 1/8"
Table size w/extensions	40" x 22"	40 3/8" x 27"
Weight:	176 lbs.	225 lbs.



10" COMPOUND MITRE SAW

- Electric brake
- Large rotating table with positive stops at 90°, 45° and 22.5°
- Ruler on fence for quick small cuts
- 24 tooth carbide blade
- Vise, stop, table extension arms, dust bag and arbor wrench included



Model No. 8328

KING INDUSTRIAL PNEUMATIC NAILERS & STAPLERS

Model No.	Description
KS 1810	18 Gauge, 1/2" - 1" Narrow Crown Stapler Kit
KN 1812L	18 Gauge, 3/8" - 1 1/4" Brad Nailer Kit
KN 1820	18 Gauge, 5/8" - 2" Brad Nailer Kit
KN 1625L	16 Gauge, 1" - 2 1/2" Finish Nailer Kit
KA 1525	15 Gauge, 1 1/4" - 2 1/2" Angle Finish Nailer Kit

* Kits include case, goggles, oil and hex key.

FASTENERS

Model No.	Length"	Box Qty
-----------	---------	---------

18 GA. 1/4" NARROW CROWN STAPLE!

NS 1812	1/2	5000
NS 1815	5/8	5000
NS 1820	3/4	5000
NS 1822	7/8	5000
NS 1825	1	5000

18 GA. BRADS

BN 1816	5/8	5000
BN 1820	3/4	5000
BN 1825	1	5000
BN 1830	1 3/16	5000
BN 1832	1 1/4	5000
BN 1838	1 1/2	5000
BN 1840	1 9/16	5000
BN 1845	1 3/4	5000
BN 1850	2	5000

COMES WITH STURDY CARRYING CASE



Model No. KS 1810



Model No. KN 1625L



Model No. KN 1812L



Model No. KA 1525



Model No. KN 1820

IMPACT WRENCHES



3/8"

CP-7722
3/8" Drive
General Duty
Impact Wrench

Max. torque: 75 ft-lb



CP-724H
3/8" Drive
Extra Heavy Duty
MINI Impact Wrench

Max. torque: 200 ft-lb



CP-721
3/8" Drive
General Duty
Impact Wrench

Max. torque: 75 ft-lb



CP-7735
3/8" Drive
Compact
Impact Wrench

- Max. working torque: 220 ft-lb in forward, 300 ft-lb in reverse
- Free speed: 10,000 rpm
- One-hand operation
- Lightweight and powerful



1/2"

FREE!
#STM-73001
NanoLight™ with
each purchase
of CP-734H.

CP-734H
1/2" Drive Heavy Duty
Air Impact Wrench

Max. torque: 425 ft-lb



CP-7733
1/2" Drive
Extra Heavy Duty
Impact Wrench

Max. torque: 550 ft-lb



CP-726H
1/2" Drive
Heavy Duty MINI
Impact Wrench

Max. torque: 200 ft-lb



CP-749
1/2" Drive Ultra Duty
Impact Wrench

Max. torque: 625 ft-lb



CP-7749
1/2" Drive
Impact Wrench

- "S2S Side-to-Side Technology" is fastest one-handed forward/reverse
- Three position regulator
- 725 ft-lbs of ultimate torque



CP-749K
1/2" Drive
Super Duty
Impact
Wrench Kit

- 625 ft-lb
- Includes 4 oz. bottle of lube and 5 sockets.



CP-734HK
1/2" Drive
Heavy Duty
Impact
Wrench Kit

- Max. torque: 425 ft-lb
- 5 free sockets



3/4"

CP-7763
3/4" Drive
Heavy Duty
Impact Wrench

- Max. torque: 1200 ft-lb
- Free speed: 6300 rpm
- Twin hammer clutch
- Three position power regulator with forward/reverse control



CP-772H
3/4" Drive
Heavy Duty
Impact Wrench

Max. torque: 1000 ft-lb



CP-776
3/4" Drive
Extra Heavy Duty
Impact Wrench

Max. torque: 1150 ft-lb



1"

CP-7774
1" Drive Heavy Duty
Reversible Pistol Grip
Impact Wrench

- 1550 ft-lbs. maximum torque
- 750 bpm • 5500 rpm
- 3 position power regulator
- Handle exhaust



CP-7778-6
1" Drive, Heavy Duty
Air Impact Wrench with 6" Anvil

- 1450 ft-lbs. ultimate torque
- 5000 rpm
- Lightweight at only 25.4 lbs
- High performance 6 vane motor
- Three position regulator and directional control, one lever for all controls
- Perfect for high volume truck tire shops



CP-7775-6
1" Drive, Heavy Duty
Air Impact Wrench with 6" Anvil

- 1550 ft-lbs. ultimate torque
- 750 bpm • 6400 rpm
- Lightweight at only 25 lbs
- Four-position power control in forward and reverse



CP-796
1" Drive Extra
Heavy Duty
Air Impact Wrench

Max. torque: 2000 ft-lb



CP-797-6
1" Drive, Heavy Duty
Air Impact Wrench with 6" Anvil

Max. torque: 1400 ft-lb



DRILLS

3/8" REVERSIBLE Standard Duty

404415 ADX380R

- Hardened steel planetary gears for long life performance
- Excellent power to weight ratio
- Forward / Reverse switch conveniently located for one handed operation
- Contoured handle design and aluminum die cast throttle offer precise operator control
- Excellent for a wide range of drilling jobs

3/8" REVERSIBLE Heavy Duty

404412 ADR380HD – with keyed chuck

404419 AD380HDR – with keyless chuck

- Designed for heavy duty use this powerful yet compact air drill features a heat treated cylinder, two steel motor bearing plates, black oxide finished rotor and full cage planetary gear mechanism for maximum service life
- Reverse valve situated for fast and easy one handed operation
- Complete with black rubber insulating grip for operator comfort and safety (905751)
- Pressure grease fitting on housing permits easy maintenance for longer tool life
- Air inlet screen prevents solid matter from entering the tool for extended tool life
- Excellent for a wide range of drilling jobs

1/2" Standard Duty

404423 RDX12

- Double reduction planetary gear system gives low speed and high torque for heavier drilling jobs
- Ball and needle bearing construction
- Auxiliary side handle included
- This 500 R.P.M. 1/2" air drill is designed for heavier steel plate drilling, cylinder honing and all jobs requiring high torque

1/2" REVERSIBLE Heavy Duty

404422 ADR12HD – with keyed chuck

404424 AD12HDR – with keyless chuck

- Heavy duty motor with double reduction planetary gear system to 800 R.P.M. provides exceptional power
- Reverse valve situated for fast and easy one handed operation
- Side handle provides maximum operator control and absorbs stall torque reaction for operator safety
- Complete with black rubber insulating grip for operator comfort and safety (905752)
- Ball and needle bearing construction
- Air inlet screen prevents solid matter from entering the tool, extends tool life

PROD. NO.	404415	404412	404423	404422
MOD. NO.	ADX380R	ADR380HD	RDX12	ADR12HD
PROD. NO.		404419		404424
MOD. NO.		AD380HDR		AD12HDR

Chuck Capacity	3/8"	3/8"	1/2"	1/2"
Reversible	Yes	Yes	No	Yes
Horsepower	.33	.50	.40	.40
Spindle Size	3/8" - 24	3/8" - 24	3/8" - 24	3/8" - 24
Free Speed R.P.M.	2,200	1,800	500	800
Overall Length	6-3/4"	7.5"	9-3/4"	9-1/2"
Weight (Lbs.)	2.75	2.70	3.74	4.8
Avg. Air Consumption (CFM)	4	4	3	4
Min. Hose Size	3/8"	3/8"	3/8"	3/8"
Air Inlet NPT	1/4"	1/4"	1/4"	1/4"
Sound Pressure (dBA)	86.8	86	87.7	83.3
Vibration (M/S²)	2.5	2.5	2.5	2.5

• FOR MAXIMUM PERFORMANCE WE RECOMMEND 90 LB PSI AIR PRESSURE



Features Heavy Duty Chuck

Features full cage planetary gear mechanism

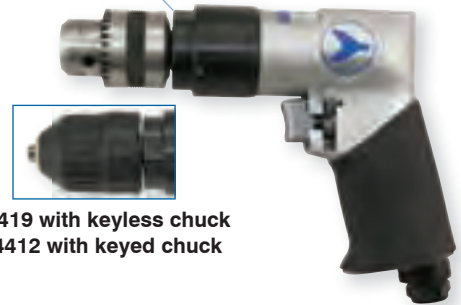

404419 with keyless chuck
404412 with keyed chuck



Features Heavy Duty Chuck



404424 with keyless chuck
404422 with keyed chuck

JET Accessories



3/8" (905753), 1/2" (905754)
Keyless Chuck



3/8" (905755), 1/2" (905756)
Industrial Keyed Chuck

DRILLS

AIR HAMMERS



.401 shank



.401 shank



MEDIUM BARREL Standard Duty

404123 AH150M

- Medium barrel delivers steady powerful blows
- Accepts popular .401 taper shank chisels
- Standard quick change spring safety retainer
- Polished aluminum one-piece housing and handle with heat treated alloy steel barrel and piston for long life
- Built in steel air regulator
- A popular choice for muffler and pipe removal, body shop work, shock work and many other automotive applications

Standard Accessory: Standard spring retainer (905146)

Optional Accessory: Quick coupler retainer (408291)

LONG BARREL Standard Duty

404124 AH150L

- Long barrel design for more hammering power
- Accepts popular .401 taper shank chisels
- Standard quick change spring safety retainer
- Polished aluminum one-piece housing and handle with hardened steel barrel and piston for long life
- Built-in steel air regulator
- Ideal for air hammering applications which require increased power

Standard Accessory: Standard spring retainer (905146)

Optional Accessory: Quick coupler retainer (408291)

AIR HAMMER KIT Super Duty

404126 AH150SD

- Super Duty .401 shank, long barrel air hammer
- "Shock Vibration Reduction" technology ensures operator comfort, safety and potential physical damage - **Check and Compare!**
- Hits harder with less effort
- Designed with an ergonomic "T" handle grip for balance and comfort
- Developed for demanding use such as: exhaust systems, front end work, bushing driving, cutting, general repairs and heavy production work
- Equipped with heavy duty quick coupler retainer for quick bit changes
- Complete with 5 bits in a blow mould case

Kit includes:

- AH150SD Air Hammer
- Quick coupler retainer (408291)
- 5 Bits; 1" O.D. Hammer
- Panel Cutter, Narrow Face Chisel
- Wide Face Chisel
- Tapered Punch



PROD. NO.
MOD. NO.

404123	404124	404126
AH150M	AH150L	AH150SD

Blows per Minute	3,500	2,000	2,000
Piston Diameter	11/16"	3/4"	3/4"
Piston Stroke	2-5/8"	3-1/2"	3-1/2"
Overall Length	6-3/4"	10-1/4"	10-1/2"
Weight (Lbs.)	3.5	4.4	4.28
Avg. Air Consumption (CFM)	4	4.2	2.77
Min. Hose Size	3/8"	3/8"	3/8"
Air Inlet NPT	1/4"	1/4"	1/4"
Sound Pressure (dBA)	99.2	98.7	101.7
Vibration (M/S²)	7.4	14.5	5.75

• FOR MAXIMUM PERFORMANCE WE RECOMMEND 90 LBS PSI AIR PRESSURE

ACCESSORIES

AIR FILTER, REGULATOR & LUBRICATOR

408803 CFR0300

- Air filter, regulator and lubricator in one unit
- Air filter is designed to eliminate dust, water and other impurities from reaching air tool, extending tool life
- Air regulator governs air flow to desired PSI air pressure
- Lubricator device is indispensable for air generated equipment, atomizing lubricant into the compressed air allowing it to reach and lubricate the internal parts of the air tool
- For use with 1/4" - 1/2" diameter air hose
- Working air pressure of 0 - 150 PSI
- Maximum working temperature: 60°C (140°F)
- 3/8" NPT air inlet and outlet



408803

AIR FILTER / REGULATOR

408807 CFRG400

- Air filter and regulator combined in one unit
- Air filter is designed to eliminate dust, water and other impurities from reaching air tool, extending tool life
- Air regulator governs air flow to desired PSI air pressure
- Working air pressure of 0 - 135 PSI
- Maximum working temperature: 60°C (140°F)
- 3/8" NPT air inlet and outlet



408807

DIAL AIR REGULATOR

408812 AR600

- Designed specifically for use with HVLP & LVLP paint spray guns
- Compact dial regulator provides precise air pressure settings for all painting applications
- Positive setting lock assures constant air pressure to the air tool
- Maximum air pressure input: 135 PSI
- Effective range of adjustment: 7 to 120 PSI
- Maximum working temperature: 60°C (140°F)
- 1/4" NPT air inlet and outlet



408812

IN-LINE AIR REGULATOR

408816 AR125

- Designed specifically for use with HVLP detail spray guns



408816

1/4" AIR TOOL OILER

408832 AAM014

- Automatically feeds oil into tool increasing performance and tool life
- Hooks up directly to air tools
- Visible oil supply provides precision oil metering
- Prevents air line contamination
- 1/4" NPT male/female threads



408832

BRASS AIR REGULATOR

408811 AR5401

- Attaches to all air tools using 1/4" NPT air inlets
- Provides quick regulation of air flow on all air tools
- 1/4" NPT male and female threads



408811

REGULATORS

SPRAY GUNS

TOUCH-UP

409114 JTG400

- Professional quality touch-up spray gun
- 8 oz. clamp type cup
- 1.2mm thick cup
- Ideal for touch-up spraying, edging, shading or precision detail painting



HIGH PRESSURE

409128 SG-1S

- Professional quality high pressure air spray gun
- Newly designed air cap assembly for a perfect nonlead spray fan effect
- Precision ground tapered stainless steel needle
- Brass aluminum rivets ensure easy on and off clamping
- Aluminum alloy body with special anti-corrosion treatment
- Chrome plated brass material and pattern adjustment controls
- This deluxe, external mix, nonbleeder industrial spray gun can handle all kinds of paint, lacquer, stain, etc. for automotive finishing, industrial applications and furniture finishing
- Not recommended for water based paints



GRAVITY FEED Professional duty Low Volume, Low Pressure

409125 SG600LVLP

- Gravity feed, low volume low pressure paint spray gun
- Low pressure operation provides wide fan pattern and superior atomization for higher productivity
- Reduces paint over-spray for lower paint costs and a cleaner, safer work area
- Nickel Chrome plated satin finish for easy cleaning and excellent resistance to chemical corrosion
- Ideal for large area paint jobs requiring professional results
- Precision machined and finished, stainless steel nozzle, needle and brass cap provide highest quality results (1.3 mm **905441**)
- Dial air regulator for precise air pressure settings for all painting applications

Standard Accessories: 600ml nylon cup with lid (**905402**),
AR600 air regulator with dial (**408812**)

Optional Accessories:

- Needle, nozzle and cap set, 1.3mm (**905441**)
- Needle, nozzle and cap set, 1.6mm (**905446**)
- Needle, nozzle and cap set, 2.0mm (**905447**)
- Nylon lid only 600 ml. cup (**905403**)
- Polished aluminum cup c/w lid 600 ml. (**905404**)
- Polished aluminum cup c/w lid 1 litre (**905412**)
- Lid only for 600 ml. polished aluminum cup (**905405**)
- Lid only for 1 litre polished aluminum cup (**905413**)
- Fine mesh paint strainer for gravity paint gun 3pc/bag.
Please order in quantity of 3 or multiples there of (**905432**)
- Fine mesh paint strainer for gravity paint gun
Please order in quantity of 10 or multiples there of (**905433**)



LVLP
MODEL



PROD. NO. MOD. NO.	409114 JTG400	409128 SG-1S	409125 SG600LVLP
Working Air Pressure (PSI)	30 - 50	43 - 90	10 - 29
Min. Compressor Size (HP)	1/3	3	2
Fluid Inlet Thread	3/8" NPS	3/8" NPS	M16 x 1.5
Nozzle Size (mm)	1.8	1.8	1.3
Weight with Cup (Lbs.)	1	2.2	1.33
Length x Height	6.5" x 9"	6.5" x 11.5"	6.5" x 13"
Avg. Air Consumption (CFM)	1	12-15	10
Air Inlet NPT	1/4"	1/4"	1/4"



Aluminum Cup



Nylon Cup









SPRAY GUNS

Oval Collar Chipping Hammer Chisels



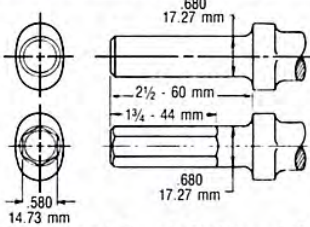

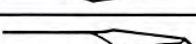



13/16" Round Material

ROUND SHANK

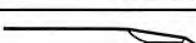
POINT STYLE	LENGTH—CATALOG NUMBER									
	8" (203mm)	9" (229mm)	12" (305mm)	18" (457mm)	24" (610mm)	36" (914mm)	48" (1219mm)	60" (1524mm)	72" (1829mm)	
BLANK 	301		301-12	301-18	301-24	301-36	301-48	301-60	301-72	
FLAT CHISEL 		303	303-12	303-18	303-24	303-36	303-48	303-60	303-72	
MOIL POINT 		313	315	315-18	315-24	315-36	315-48	315-60	315-72	
WIDE FLAT 1 1/2" (38mm) 2" (51mm) 3"		325 323 323-3	325-12 323-12	325-18 323-18	325-24 323-24	325-36 323-36	325-48 323-48	325-60 323-60	325-72 323-72	
CAPE CHISEL 		305	305-12	 <p>Navy Standard Oval Collared Shanks</p>						
ROUND NOSE 		307	307-12							
DIAMOND POINT 		309	309-12							
GOUGE 		337	337-12							

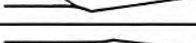
HEX SHANK

POINT STYLE	LENGTH—CATALOG NUMBER									
	8" (203mm)	9" (229mm)	12" (305mm)	18" (457mm)	24" (610mm)	36" (914mm)	48" (1219mm)	60" (1524mm)	72" (1829mm)	
BLANK 	302		302-12	302-18	302-24	302-36	302-48	302-60	302-72	
FLAT CHISEL 		304	304-12	304-18	304-24	304-36	304-48	304-60	304-72	
MOIL POINT 		314	316	316-18	316-24	316-36	316-48	316-60	316-72	
WIDE FLAT 1 1/2" (38mm) 2" (51mm) 3"		326 324 324-3	326-12 324-12	326-18 324-18	326-24 324-24	326-36 324-36	326-48 324-48	326-60 324-60	326-72 324-72	
CAPE CHISEL 		306	306-12	<p>Tools shown in this catalog are the most commonly used styles and are available up to 72" OAL. However, other shapes and even longer sizes are available upon special order. Send samples or drawings for shapes not found in our pages.</p>						
ROUND NOSE 		308	308-12							
DIAMOND POINT 		310	310-12							
GOUGE 		338	338-12							

Bushing Tools

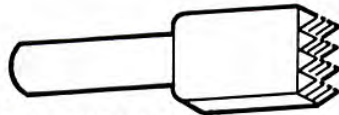

TWO PIECE BUSH TOOL ASSEMBLY

Available in either round collar or oval collar shanks. Both stems and head can be ordered separately.

BUSH TOOL ASSEMBLY (2 Pieces)

OVAL COLLAR PART NO.	RD. COLLAR PART NO.	CUTTING EDGE	LENGTH	SHANK
343	443	1-1/2" sq. (38mm)	9-1/2" (241mm)	Rd.
344	444	1-1/2" sq. (38mm)	9-1/2" (241mm)	Hex.

50100 RD. SK. OC (1 pc.) Bush Tool

BUSH TOOL REPLACEMENT STEMS ONLY

OVAL COLLAR PART NO.	RD. COLLAR PART NO.	CUTTING EDGE	LENGTH	SHANK
345	445		8" (203mm)	Rd.
346	446		8" (203mm)	Hex.

REPLACEMENT HEAD ONLY

OVAL COLLAR PART NO.	RD. COLLAR PART NO.	CUTTING EDGE	LENGTH	SHANK
5101	5101	1-1/2" (38mm)	—	—



PREMIUM CLASS



	MAB100	MAB200	MAB425	MAB455	MAB485	MAB500
Tool holder	Direct tool holder 3/4" Weldon	Direct tool holder 3/4" Weldon	Direct tool holder 3/4" Weldon	Keyless Sys. 3/4" Weldon	Keyless Sys. 3/4" Weldon	Keyless Sys. 3/4" Weldon
Shank		1/2"-20	1/2"-20	MT 2	MT 2	MT 3
Core drill short Ø	30 mm 1-3/16"	32 mm 1-1/4"	35 mm 1-3/8"	40 mm 1-9/16"	40 mm 1-9/16"	50 mm 2"
Core drill long Ø				40 mm 1-9/16"	40 mm 1-9/16"	50 mm 2"
Twist drill Ø			16 mm 5/8"	18 mm 3/4"	18 mm 3/4"	23 mm 15/16"
Tapping Ø					M16 5/8"	
Countersinking Ø					40 mm 1-9/16"	50 mm 2"
Reaming Ø					18 mm 3/4"	23 mm 15/16"
Speed 1	450	450	430	250	50 - 250	90 - 280
Speed 2			760	450	100 - 450	180 - 580
Speed 3						
Speed 4						
Permanent internal lubrication	✓	✓	✓	✓	✓	✓
Full wave control electronics					✓	✓
Right / left rotation					✓	
Automatic feed / return						
Automatic feed						
Overheating protection					✓	✓
Safety friction clutch						
Torque control						✓
Magnet indicator	✓	✓	✓	✓	✓	✓
Stroke	80 mm 3-1/8"	150 mm 6"	160 mm 6-5/16"	160 mm 6-5/16"	160 mm 6-5/16"	150 mm 6"
Weight	9,9 kg 21,8 lbs	12 kg 26,5 lbs	13 kg 28,5 lbs	13 kg 28,5 lbs	13 kg 28,5 lbs	19,5 kg 43 lbs
Magnet holding power	15 000 N 3375 lbs/foot	15 000 N 3375 lbs/foot	15 000 N 3375 lbs/foot	18 500 N 4180 lbs/foot	18 500 N 4180 lbs/foot	20 000 N 4496 lbs/foot
Power consumption	800 watts	900 watts	1050 watts	1150 watts	1150 watts	1600 watts



- Universal shank fitting most core drilling machines;
- special steel alloy called "XE" for extreme hardness up to 68 HRC;
- surface treatment for a longer tool life;
- extreme hardness on the teeth tips and more flexibility due to the step hardening process;
- optimized cutting geometry depending on diameter results to immediate self-centering and smooth cutting with regular chip flow.



Performance at low cost !!

Universal shank 3/4"	
GOLD-TECH Surface treatment	
2-CUT High perf. geometry	
"XE" Special steel	
Step hardening	
Fully ground spiral	

NOTE
All Gold-Tech cutters are available with TiAlN-Durablue coating for high performance.

fraction Ø	Cutting depth: 1-3/16"		Cutting depth: 2-5/32"		Cutting depth: 3-5/32"	
	ITEM	ITEM	ITEM	ITEM	ITEM	ITEM
	20.1610		20.1620		20.1625	
7/16"	100HSS02864		200HSS02864			
1/2"	100HSS03264		200HSS03264			
9/16"	100HSS03664		200HSS03664			
5/8"	100HSS04064		200HSS04064			
11/16"	100HSS04464		200HSS04464			300HSS04464
3/4"	100HSS04864		200HSS04864			300HSS04864
13/16"	100HSS05264		200HSS05264			300HSS05264
7/8"	100HSS05664		200HSS05664			300HSS05664
15/16"	100HSS06064		200HSS06064			300HSS06064
1"	100HSS06464		200HSS06464			300HSS06464
1-1/16"	100HSS06864		200HSS06864			300HSS06864
1-1/8"	100HSS07264		200HSS07264			300HSS07264
1-3/16"	100HSS07664		200HSS07664			300HSS07664
1-1/4"	100HSS08064		200HSS08064			300HSS08064
1-5/16"	100HSS08464		200HSS08464			300HSS08464
1-3/8"	100HSS08864		200HSS08864			300HSS08864
1-7/16"	100HSS09264		200HSS09264			300HSS09264
1-1/2"	100HSS09664		200HSS09664			300HSS09664
1-9/16"	100HSS10064		200HSS10064			300HSS10064
1-5/8"	100HSS10464		200HSS10464			300HSS10464
1-11/16"	100HSS10864		200HSS10864			300HSS10864
1-3/4"	100HSS11264		200HSS11264			300HSS11264
1-13/16"	100HSS11664		200HSS11664			300HSS11664
1-7/8"	100HSS12064		200HSS12064			300HSS12064
1-15/16"	100HSS12464		200HSS12464			300HSS12464
2"	100HSS12864		200HSS12864			300HSS12864
2-1/16"	100HSS13264		200HSS13264			300HSS13264

GOLD-TECH HSS-XE CORE DRILL SETS

INCH SIZES

- Sets include 6 core drills (9/16", 5/8", 3/4", 13/16", 15/16" and 1-1/16") 1-3/16" or 2-5/32" cutting depth and 4 ejector pins.

METRIC SIZES

- Sets include 6 core drills (14, 16, 19, 21, 24 and 27 mm) 30 or 55 mm cutting depth and 4 ejector pins.

cutting depth	ITEM
1-3/16"	100HSSKIT
2-5/32"	200HSSKIT
30 mm	100HSSKIT-M
55 mm	200HSSKIT-M





- Universal shank fitting most core drilling machines;
- conical spiral for efficient chip removal resulting in regular chip flow and smooth cutting action;
- sophisticated 3-CUT geometry which results in increased tool life, smooth cutting action and excellent cutting capacity.



Universal shank

3-CUT Geometry

Conical spiral



fraction Ø	Cutting depth: 1-9/16"		Cutting depth: 2-5/32"		Cutting depth: 3-5/32"	
	ITEM	ITEM	ITEM	ITEM	ITEM	ITEM
	20.1630		20.1640		20.1670	
1/2"	100TCT03264		200TCT03264			
9/16"	100TCT03664		200TCT03664			
5/8"	100TCT04064		200TCT04064			
11/16"	100TCT04464		200TCT04464			300TCT04464
3/4"	100TCT04864		200TCT04864			300TCT04864
13/16"	100TCT05264		200TCT05264			300TCT05264
7/8"	100TCT05664		200TCT05664			300TCT05664
15/16"	100TCT06064		200TCT06064			300TCT06064
1"	100TCT06464		200TCT06464			300TCT06464
1-1/16"	100TCT06864		200TCT06864			300TCT06864
1-1/8"	100TCT07264		200TCT07264			300TCT07264
1-3/16"	100TCT07664		200TCT07664			300TCT07664
1-1/4"	100TCT08064		200TCT08064			300TCT08064
1-5/16"	100TCT08464		200TCT08464			300TCT08464
1-3/8"	100TCT08864		200TCT08864			300TCT08864
1-7/16"	100TCT09264		200TCT09264			300TCT09264
1-1/2"	100TCT09664		200TCT09664			300TCT09664
1-9/16"	100TCT10064		200TCT10064			300TCT10064
1-5/8"	100TCT10464		200TCT10464			300TCT10464
1-11/16"	100TCT10864		200TCT10864			300TCT10864
1-3/4"	100TCT11264		200TCT11264			300TCT11264
1-13/16"	100TCT11664		200TCT11664			300TCT11664
1-7/8"	100TCT12064		200TCT12064			300TCT12064
1-15/16"	100TCT12464		200TCT12464			300TCT12464
2"	100TCT12864		200TCT12864			300TCT12864
2-1/16"	100TCT13264		200TCT13264			300TCT13264

T.C.T. CORE DRILL SETS

INCH SIZES

- Sets include 6 core drills (9/16", 5/8", 3/4", 13/16", 15/16" and 1-1/16") 1-3/16" or 2-5/32" cutting depth and 4 ejector pins.

METRIC SIZES

- Sets include 6 core drills (14, 16, 19, 21, 24 and 27 mm) 40 or 55 mm cutting depth and 4 ejector pins.

cutting depth	ITEM
1-9/16"	100TCTKIT
2-5/32"	200TCTKIT
40 mm	100TCTKIT-M
55 mm	200TCTKIT-M



Hole Saws



● Six sizes most commonly used by plumbers. One of each HSS Bi-Metal hole saw: 3/4", 7/8", 1 1/8", 1 1/2", 1 3/4" and 2 1/4". One 3/8" hex. and one 7/16" hex. arbor complete with removable pilot drills and one ejector spring. Supplied in impact resistant case.

- **Positive tooth angle**
For more aggressive cutting and faster cuts.
- **Greater cutting depth**
Allows to cut deeper than standard hole saws.
- **Variable tooth pitch**
For better chip clearance, smoother cut and less vibration.
- **Vacuum heat treatment**
Assures optimum hardness and longest life of the M3 HSS cutting edge.



Diameter		Order No.	Use Arbor	Pipe Ent. and Conduit Size	Copper Pipe and Pipe Tap Sizes	Diameter		Use Arbor	Pipe Ent. and Conduit Size	Copper Pipe and Pipe Tap Sizes	
Inch	MM					Inch	MM				
9/16"	14	70 009	A, B or C			2"	51	70 200	1 1/2"		
5/8"	16	70 010					2 1/16"	52	70 201		
11/16"	17	70 011					2 1/8"	54	70 202		
3/4"	19	70 012			3/8"	1/2"	2 1/4"	57	70 204		2"
13/16"	21	70 013					2 5/16"	59	70 205		
7/8"	22	70 014			1/2"	3/4"	2 3/8"	60	70 206		
15/16"	24	70 015					2 1/2"	64	70 208	2"	
1"	25	70 100					2 9/16"	65	70 209		
1 1/16"	27	70 101					2 5/8"	67	70 210		2 1/2"
1 1/8"	29	70 102			3/4"	1"	2 3/4"	70	70 212		
1 3/16"	30	70 103					2 7/8"	73	70 214		
1 1/4"	32	70 104					3"	76	70 300	2 1/2"	
1 3/8"	35	70 106			1"		3 1/8"	79	70 302		
1 1/2"	38	70 108			1 1/4"	3 1/4"	83	70 304		3"	
1 1/4"	32	70 124				3 3/8"	86	70 306			
1 5/16"	33	70 125				3 1/2"	89	70 308			
1 3/8"	35	70 126		1"		3 5/8"	92	70 310	3"		
1 7/16"	37	70 127				3 3/4"	95	70 312		3 1/2"	
1 1/2"	38	70 128			1 1/4"	3 7/8"	98	70 314			
1 9/16"	40	70 129				4"	102	70 400			
1 5/8"	41	70 130				4 1/8"	105	70 402	3 1/2"		
1 11/16"	43	70 131				4 1/4"	108	70 404		4"	
1 3/4"	44	70 132		1 1/4"	1 1/2"	4 3/8"	111	70 406			
1 13/16"	46	70 133				4 1/2"	114	70 408			
1 7/8"	48	70 134				4 3/4"	121	70 412	4"	4 1/2"	
						5"	127	70 500			
						5 1/2"	140	70 508			
						6"	152	70 600			

Individually packaged in cardboard boxes.



- **New carbide tip**
Geometry of the tip allows faster drilling times and better centering. The higher carbide content increases bit life. New grade of carbide for increased impact and wear resistance.
- **New high efficiency "Asymmetric" flute design**
Increases the hitting power transmission. Reduces wear and quickly evacuates dust.
- **Heat treated chrome nickel steel body**
Precision made and unique shot peening technology for maximum



	Diameter		Overall Length	Order No.
	Inch	MM		
	5/32"	4	4"	74 505
<i>New size!</i>	5/32"	4	6"	74 605
	3/16"	5	4"	74 506
	3/16"	5	6"	74 606
<i>New size!</i>	3/16"	5	12"	74 706
	-	6	6"	74 806
	1/4"	6.5	4"	74 508
	1/4"	6.5	6"	74 708
	1/4"	6.5	8"	74 808
<i>New size!</i>	1/4"	6.5	12"	74 908
	5/16"	8	6"	74 510
	5/16"	8	8"	74 710
<i>New size!</i>	5/16"	8	12"	74 810
	3/8"	10	6"	74 512
	3/8"	10	10"	74 712
	7/16"	11	6"	74 514
	15/32"	12	6"	74 515
	15/32"	12	8"	74 715

	Diameter		Overall Length	Order No.
	Inch	MM		
	1/2"	13	6"	74 516
	1/2"	13	10"	74 716
<i>New size!</i>	1/2"	13	18"	74 816
<i>New size!</i>	1/2"	13	24"	74 916
<i>New size!</i>	9/16"	14	6"	74 518
	5/8"	16	8"	74 520*
	5/8"	16	12"	74 620*
	5/8"	16	18"	74 720*
<i>New size!</i>	5/8"	16	24"	74 820*
<i>New size!</i>	11/16"	18	8"	74 522*
	3/4"	19	9"	74 524*
	3/4"	19	12"	74 624*
	3/4"	19	18"	74 724*
<i>New size!</i>	3/4"	19	24"	74 824*
	7/8"	23	10"	74 528*
	7/8"	23	18"	74 728*
	1"	26	10"	74 600*
	1"	26	18"	74 800*
<i>New size!</i>	1-1/8"	29	10"	74 804*

Individually packaged in vinyl pouches. *Available in Triathlon geometry in Spring 2001.

Triathlon VEE FLUTE™ Concrete Bit

WIRE AND SPECIAL TOOLS



TIE WIRE REEL



PISTOL GRIP



SPRING RETURN TOOL



COLD CHISEL

FORM TOOL



STEEL WIRE
NO. 9 - 12 - 16
50 POUNDS ROLLS



COIL TIE WIRE
NO. 16



MECHANIC'S WIRE



WIRE PLIERS
No. 10008 - 100010

WIRE & CABLE STAPLE GUN TACKERS

T25M LOW VOLTAGE WIRE STAPLE GUN

T75 WIRE & CABLE STAPLE GUN
CSA APPROVED

STAPLES FOR WIRE & CABLE STAPLE GUN TACKERS

Model No.	Dimensions	Qty/ Pkg
T25	3/8", 10 mm	1000
T25	7/16", 11mm	1000
T25	9/16", 14 mm	1000
T75	9/16", 14 mm	1000
T75	5/8", 16 mm	1000
T75	5/8", 16 mm	1000
T75	7/8", 22 mm	1000
T75	7/8", 22 mm	1000



MUSIC WIRE (PIANO WIRE)

MUSIC WIRE is made of high carbon steel alloy that combines extremely high tensile strength with high fatigue resistance. Tensile strength runs from approximately 250,000 psi for .180" dia. wire to 450,000 psi for .006 dia. wire. Its many applications include springs, wire forms, control linkages, armature binding, ceramic cutting, and a variety of industrial uses. Music wire is available in 1 lb. or 1/4 lb. packages in 49 different diameters from .006" to .180".

SILICONE SEALANTS

Properties

Base/Catalyst Mix Ratio

Catalyst type

Color

Aluminum, black, clear, white

Corrosion Resistance

Dielectric

550

Strength, volts/mil

2.8

Dielectric constant at 100kHz

Duro

25

Elongation %

600

Extrusion Force, lbs

Extrusion Rate, gr/min

350

Flamability Classification

Physical Form

Rubber

S. Gravity

1.04

Specification

Tack free time, min

20

Tensile, psi

325

Type

Type, Class, Group

Viscosity CP



No. 732-RTV



300ML CARTRIDGES

90ML TUBES

WHITE OR CLEAR



Hoppers

No 684 36" x 36" — 8"

No 685 36" x 36" — 12"

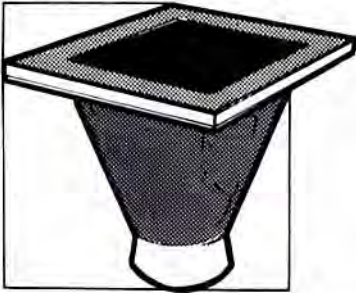

Elephant Trunk

No 681 — 6" 50'/R No. 690

No 682 — 8" 50'/R Steel Clamp for 6" to 12"

No 683 — 12" 50'/R steel collars and hoppers.

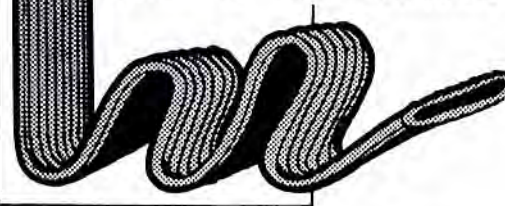

No. 690

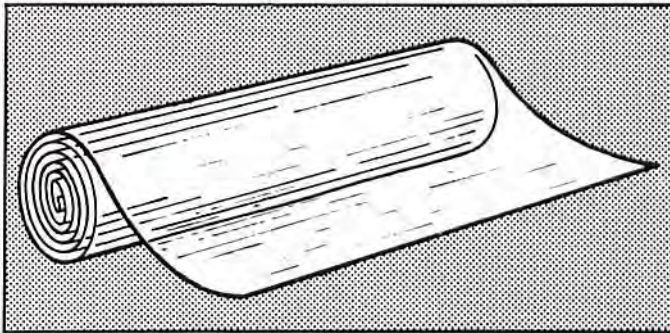

Polyethylene

Used as:

- Vapour seal under concrete slabs
- Temporary construction
- Temporary covering for materials and equipment

Tarpaulin

Reduces winter construction costs.

Transparent

- Work performed in natural daylight.

Light in Weight – Flexible

- 15'-0" x 20'-0" Heavy Duty SAFT-TARP. Weighs approximately 27 lbs.

Regular Style

- Twin enforced grommets spaced 3'-0" to 3'-4".



Automotive & tarps

TARPAULIN

Rope, reinforced hems, reinforced corners, double laminated, rotproof, waterproof, heavy duty, in blue colour or white translucent, ten times stronger than canvas, rust resistant grommets, crack resistant. In poly bag with bar code.



BLUE COLOUR

Weaving 8x8 sq. in.

Product number	Cut size pi. / ft.	Approx. dim. finish prod. pi.-po. / ft.-in.	Boîte Box	Emb. Pack
TRP810	8' x 10'	7'-9" x 9'-9"	10	1
TRP1012	10' x 12'	9'-9" x 11'-7"	10	1
TRP1015	10' x 15'	9'-9" x 14'-7"	10	1
TRP1018	10' x 18'	9'-9" x 17'-7"	5	1
TRP1216	12' x 16'	11'-9" x 15'-7"	5	1
TRP1218	12' x 18'	11'-9" x 17'-7"	5	1
TRP1220	12' x 20'	11'-9" x 19'-7"	5	1

WHITE

Weaving 8x8 sq. in.

Product number	Cut size pi. / ft.	Approx. dim. finish prod. pi.-po. / ft.-in.	Box	Pack
TW810	8' x 10'	7'-9" x 9'-9"	10	1
TW1012	10' x 12'	9'-9" x 11'-7"	10	1
TW1015	10' x 15'	9'-9" x 14'-7"	10	1
TW1018	10' x 18'	9'-9" x 17'-7"	5	1
TW1216	12' x 16'	11'-9" x 15'-7"	5	1
TW1218	12' x 18'	11'-9" x 17'-7"	5	1
TW1220	12' x 20'	11'-9" x 19'-7"	5	1

Weaving 10x10 sq. in.

Product number	Cut size pi. / ft.	Approx. dim. finish prod. pi.-po. / ft.-in.	Box	Pack
TRP1620	16' x 20'	15'-8" x 19'-5"	6	1
TRP1824	18' x 24'	17'-8" x 23'-5"	5	1
TRP2030	20' x 30'	19'-4" x 29'-3"	2	1
TRP2440	24' x 40'	23'-4" x 39'-3"	1	1
TRP3050	30' x 50'	29'-4" x 49'-3"	1	1

Weaving 10x10 sq. in.

Product number	Cut size pi. / ft.	Approx. dim. finish prod. pi.-po. / ft.-in.	Box	Pack
TW1620	16' x 20'	15'-8" x 19'-5"	6	1
TW1824	18' x 24'	17'-8" x 23'-5"	5	1
TW2030	20' x 30'	19'-4" x 29'-3"	2	1
TW2440	24' x 40'	23'-4" x 39'-3"	1	1
TW3050	30' x 50'	29'-4" x 49'-3"	1	1

HEAVY DUTY EPDM RUBBER TARP STRAP WITH HOOKS

Resists outdoor aging and cracking. With bar code sticker.

Product number	Length po. / in.	Pack
TS15	15"	10
TS20	20"	10
TS30	30"	1
TS40	40"	1



ELASTIC TIE DOWN STRAP

Multi purpose elastic strap with two hooks. In poly bag with bar code.

ES18	18"	10
ES24	24"	10
ES30	30"	10





Industrial Film 4000 Series - General Purpose Polyethylene Film

The **4000 Film Series** clear and black polyethylene product line has a wide selection of sizes and gauges for general industrial, agricultural and construction applications.

Ralston's Series 4000 is made using premium blends of "linear rich" polyethylene resin. We offer an extensive stock size portfolio as well as custom made "poly" using different "slip" components, extra UV stabilizers, special additive packages, and a dozen other features to fit the specific needs of the Canadian film marketplace.

Main properties:

- All our film is packed in clear PE sleeves with product identification labels both inside and outside the sleeve.
- All pallets are wrapped for safer transportation and easier storage.
- Colour coded labels are provided for identification of size and product type.
- Available in all standard sizes.
- Available with custom formulas.
- Available in custom lengths and widths.
- Warehoused in three locations across the country.
- Linear rich formula provides superior strength.

Product Code	Width Inches x Length Feet	Square Feet	Grade	Width Feet x Length Feet	Fold	Core Length Inches	Colour	Skid
4114-00	102" x 177'	1500	Utility	8.5 x 177	JF	53	☐ Clear	225
4200-02 x4	12" x 1000'	1000	** Light - 4 rolls	1.0 x 1000	LF	12.5	☐ Clear	60
4204-00	36" x 500'	1500	Light	3.0 x 500	LF	37	☐ Clear	156
4208-00	50" x 360'	1500	Light	4.2 x 360	LF	53	☐ Clear	156
4210-00	72" x 250'	1500	Light	6.0 x 250	CF	37	☐ Clear	156
4213-00	102" x 59'	500	Light	8.5 x 59	JF	53	☐ Clear	306
4214-00	102" x 177'	1500	Light	8.5 x 177	JF	53	☐ Clear	156
4216-00	120" x 150'	1500	Light	10.0 x 150	4F	31	☐ Clear	143
4219-00	120" x 500'	5000	** Light	10.0 x 500	4F	31	☐ Clear	49
4224-00	240" x 100'	2000	Light	20.0 x 100	4F	62	☐ Clear	169
4229-00	120" x 150'	1500	Light	10.0 x 150	CF	62	☐ Clear	168
4304-00	36" x 500'	1500	Medium	3.0 x 500	LF	37	☐ Clear	90
4308-00	50" x 360'	1500	Medium	4.2 x 360	LF	53	☐ Clear	100
4310-00	72" x 250'	1500	Medium	6.0 x 250	CF	37	☐ Clear	90
4313-00	102" x 59'	500	Medium	8.5 x 59	JF	53	☐ Clear	210
4314-00	102" x 177'	1500	Medium	8.5 x 177	JF	53	☐ Clear	90
4315-00	120" x 100'	1000	Medium	10.0 x 100	4F	31	☐ Clear	110
4316-00	120" x 150'	1500	Medium	10.0 x 150	4F	31	☐ Clear	72
4318-00	120" x 250'	2500	** Medium	10.0 x 250	4F	31	☐ Clear	49
4320-00	144" x 100'	1200	Medium	12.0 x 100	4F	37	☐ Clear	90
4324-00	240" x 100'	2000	Medium	20.0 x 100	4F	62	☐ Clear	90
4324-01	240" x 100'	2000	Medium	20.0 x 100	4F	62	■ Black	90
4328-00	120" x 100'	1000	Medium	10.0 x 100	CF	62	☐ Clear	156
4328-01	120" x 100'	1000	Medium	10.0 x 100	CF	62	■ Black	156
4406-00	44" x 273'	1000	Heavy	3.7 x 273	LF	45	☐ Clear	81
4410-00	72" x 250'	1500	Heavy	6.0 x 250	CF	37	☐ Clear	64
4413-00	102" x 59'	500	Heavy	8.5 x 59	JF	53	☐ Clear	156
4414-00	102" x 177'	1500	Heavy	8.5 x 177	JF	53	☐ Clear	72
4415-00	120" x 100'	1000	Heavy	10.0 x 100	4F	31	☐ Clear	72
4416-00	120" x 150'	1500	Heavy	10.0 x 150	4F	31	☐ Clear	56
4417-00	120" x 167'	1670	** Heavy	10.0 x 167	4F	31	☐ Clear	49
4420-00	144" x 100'	1200	Heavy	12.0 x 100	4F	37	☐ Clear	72
4423-00	192" x 100'	1600	Heavy	16.0 x 100	4F	53	☐ Clear	64
4424-00	240" x 100'	2000	Heavy	20.0 x 100	4F	62	☐ Clear	64
4424-01	240" x 100'	2000	Heavy	20.0 x 100	4F	62	■ Black	64
4428-00	120" x 100'	1000	Heavy	10.0 x 100	CF	62	☐ Clear	110
4428-01	120" x 100'	1000	Heavy	10.0 x 100	CF	62	■ Black	110
4515-00	120" x 100'	1000	X-Heavy	10.0 x 100	4F	31	☐ Clear	49
4516-00	120" x 150'	1500	X-Heavy	10.0 x 150	4F	31	☐ Clear	30
4524-00	240" x 100'	2000	X-Heavy	20.0 x 100	4F	62	☐ Clear	42

* Price shown is per case - sold in full cases only - 4 rolls/case

** Dispenser Rolls are printed with grade & footmarkers; all other film is unprinted.



WELDING ACCESSORIES

Super Tomahawk



- Cone and chisel
- Coil handle
- Steel shaft

Part No. H

Sparklighter



- Single flint
- Ignites every time
- Renewal flints available (F1)

Part No. WSFL

Sparklighter



- Triple flint
- Quick ignition
- Renewal flints available (TF1)

Part No. WTFL

Long Neck Tomahawk



- Cone and chisel
- Wooden handle
- Use for weld slag only

Part No. WH20
Part No. WH30

Tip Cleaners



- Tip cleaners and file in metal case
- Standard for small and medium, drill size #75-49, 12 tips
- Jumbo for large tips, drill size #48-30, set of 9

Part No.
FPTL (standard)
WYP4 (long)
TC2 (jumbo)

Soapstone Holder Round



- Soapstone included
- Turn cap to release or lock
- Outer shell for protection
- Replacement soapstones available (SR)

Part No. WHR

Steel Chipping Hammer

Part No. WH



Soapstone Holder Flat



- Soapstone included
 - Pocket clip
 - 5 in. aluminum body
 - Replacement soapstones available (SPF)
- Part No. WHF

Set-Up Wedges

Product Number	Length, Inches	Width, Inches	Maximum Thickness, Inches	Weight, Lbs.
79-493	3	1	1/4	.11
79-495	5	1	1/2	.31
79-496	6	1-1/4	3/4	.68



SIZE	DESCRIPTION	PIPE SIZE	STOCK NUMBER
Small	Width 2 1/2", Length 2'	1" to 3" pipe	150
	With TUFF-Edge®		150 TE
Medium	* Width 4", Length 4'	3" to 6" pipe	160
	* With TUFF-Edge®		160 TE
Large	* Width 4", Length 6'	3" to 10" pipe	170
	* With TUFF-Edge®		170 TE
X-Large	* Width 4", Length 7'	6" to 14" pipe	177
	* With TUFF-Edge®		177 TE
X-X-Large	* Width 4", Length 9'	8" to 18" pipe	179
	* With TUFF-Edge®		179 TE
Special "4"	Width 4", x Length desired		184
Special "7"	Width 7", x Length desired		187

WELLER

SOLDERING GUNS



Soldering wire
different sizes
and types

Model No.	Reference	Description	V	W	Hz	Weight	
						lb	kg
D550PK	037103475428	Soldering gun kit	120	260/200	50/60	13	5.88
8250DPK	037103476005	Soldering gun kit	240	260/200	50/60	13	5.88

H.K. PORTER

HYDRAULIC CABLE CUTTERS

For aluminum and copper

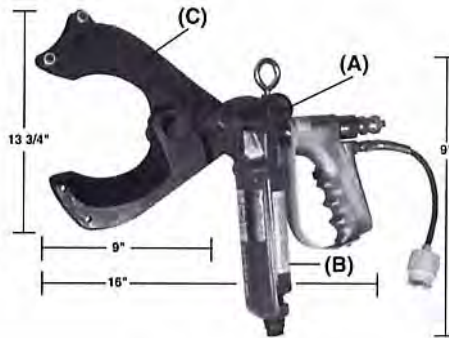

W177089



179089

CABLE CUTTERS

FOR WIRE ROPES AND ELECTRIC CABLES

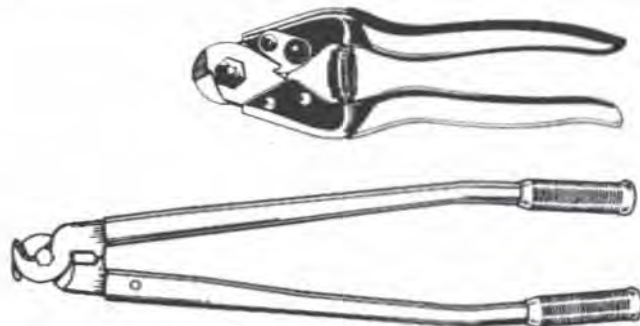

Xcelite

Miniature tools kits



BERNZOMATIC®

OXYGEN/MAPP® GAS BRAZING/ WELDING/ CUTTING TORCH KIT

Uses oxygen and propane or MAPP® gas.

Includes:

- Burner wand
- Hose
- Oxygen regulator
- Fuel gas valve
- Cylinder stand
- 16.0 oz. MAPP® gas cylinder
- 1.1 cubic foot oxygen cylinder
- Spark lighter



TRIGGER START CAST ALUMINUM MAPP® GAS TORCH KIT

- Regulated for cold weather use
- Includes stainless steel burn tubes
- Compatible with both MAPP® and propane gases

Includes:

- torch head
- 16.0 oz. MAPP® gas cylinder



TS4000ZKC

OX2550KC

PENCIL FLAME TORCH KIT

- Solid brass construction
- General purpose utility flame
- Needle valve control and filtered orifice

Includes:

- torch unit
- 14.1 oz. propane cylinder



TRIGGER START CAST ALUMINUM PROPANE TORCH

Burns propane or converts to hotter MAPP® gas. Features stainless steel burntube, cast aluminum body, and brass burntip. Convenient locking button holds continuous flame if needed.

TS4000T



QUICKFIRE™ TRIGER START TORCH

- Comfortable, easy grip
- Self igniting quick-start trigger
- Uses propane gas
- Solid brass burn tip for easy repairs
- Pressure regulated to burn upside down

TORCH HEAD

TS3000T

TORCH KIT

TS3000KC



TRIGGER START SWIVEL HEAD TORCH

Specially designed for convenience and accessibility.

- Solid brass regulator provides greater durability
- 360° swiveling torch head provide versatility and accessibility to tight and awkward work spaces
- Slim, one-handed trigger-start eliminates the need for external ignition sources
- Double "O" ring connection helps prevent gas leaks
- Uses MAPP® gas

TORCH HEAD

TS99T



FUELS

BERNZOMATIC 14.1 OUNCE DISPOSABLE PROPANE CYLINDER

Use with torches and most portable appliances requiring propane.

BERNZOMATIC 16 OUNCE DISPOSABLE MAPP® GAS CYLINDER

MAPP® gas burns hotter than propane. Use only with torches and appliance specifying "for use with MAPP® gas or propylene".



FAT BOY





Construction heater / Construction Heater RCH-100

Construction Heater RCH-100 (765-193)

code :	765-193	model :	RCH
consumption :	100,000 BTU	dimensions :	N/A
packaging :	Individuel	capacity :	N/A
gasl type :	Propane et Natural	color :	Grey
weight :	45 LBS		

Construction heater / Construction heater M-375B

Construction heater M-375B (611-030)

Construction Heater 375,000 BTU also available with blower



code :	611-030	model :	N/A
consumption :	375,000 BTU	dimensions :	N/A
packaging :	Individuel	capacity :	N/A
gasl type :	Propane	color :	Grey
weight :	80 LBS		
include :	High pression regulator and 20' hose		

Torches and burners



Liquid burners 300,000 to 2,000,000 BTU



Liquid Torches 300,000 to 2,000,000 BTU



Torche 200,000 BTU



Torche 400,000 BTU

Temporary heating / Portable Infra Red heater B-15

Portable Infra Red heater B-15 (765-001)



code :	765-001	model :	B-15
consumption :	15,000 BTU	dimensions :	N/A
packaging :	Individuel	capacity :	N/A
gasl type :	Propane	color :	Red
weight :	11 LBS		

include : Regulator and 6' hose

Wire goods & fasteners

GALVANIZED WIRE

With dispenser.
With bar code sticker.



1511-19

Product number	Gauge	Length	
		m	pi. / ft.
1511-19	19	50	164'

GENERAL PURPOSE WIRE

All purpose, galvanized,
rust resistant. Pliable strong wire.
Display card with bar code.



462

462-14	14	58'
462-16	16	95'
462-18	18	166'

IRON WIRE

Black annealed 16 GA, rebar tie
wire coil to fit STD tie wire reel.
With bar code sticker.



ASWG16

Product number	Length		Weight / Roll	Weight / Carton	Box	Pack
	pi. / ft.	m				
ASWG16	394'	120	3-1/8	50	16 rl	1 rl

BRASS SNARE WIRE

In poly bag.
With bar code sticker.



P798

Product number	Gauge	Length	Coil	Box	Pack
P798	21	20'	1	20	1

POULTRY NETTING

Galvanized, hexagonal.

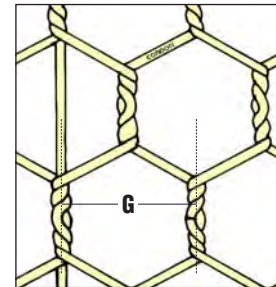

PLT



Product number	G		Width	Feet / Reel	Gauge
	Maille / Mesh	po. / in.			
PLT2425	1"	24"	24"	25'	22
PLT3625	1"	36"	36"	25'	22
PLT4825	1"	48"	48"	25'	22
PLT2450	1"	24"	24"	50'	22
PLT3650	1"	36"	36"	50'	22
PLT4850	1"	48"	48"	50'	22
PLT24150	1"	24"	24"	150'	22
PLT36150	1"	36"	36"	150'	22
PLT48150	1"	48"	48"	150'	22
PLT60100	1"	60"	60"	100'	22
PLT72100	1"	72"	72"	100'	22

HARDWARE CLOTH

Galvanized.

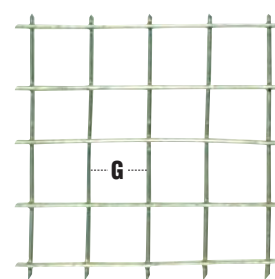

HCL

HCL03-36	1/8"	36"	50'	27
HCL06-10	1/4"	36"	10'	23
HCL06-24	1/4"	24"	50'	23
HCL06-30	1/4"	30"	50'	23
HCL06-36	1/4"	36"	50'	23
HCL10-10	3/8"	36"	10'	21
HCL10-36	3/8"	36"	50'	21
HCL13-10	1/2"	36"	10'	20
HCL13-24	1/2"	24"	50'	20
HCL13-30	1/2"	30"	50'	20
HCL13-36	1/2"	36"	50'	20
HCL13-48	1/2"	48"	50'	20
HCL19-36	3/4"	36"	100'	19
HCL25-36	1"	36"	100'	19

Hardware - Doors & windows, casters

BRASS PADLOCK

Solid brass with hardened steel shackle, anti-pick mushroom pins, stainless steel springs. Single locking on Nos 631 & 632. Double locking on series 800. On card with bar code.

Product number	A		H		Box	Pack
	po. / in.	mm	po. / in.	mm		
C631KDC	3/4"	12	12	12	12 ct/cd	1 ct/cd
C632KDC	1"	14	14	12	12 ct/cd	1 ct/cd
C833KDC	1-1/4"	20	20	12	12 ct/cd	1 ct/cd
C834KDC	1-1/2"	23	23	12	12 ct/cd	1 ct/cd
C835KDC	1-3/4"	26	26	12	12 ct/cd	1 ct/cd
C836KDC	2"	29	29	6	6 ct/cd	1 ct/cd

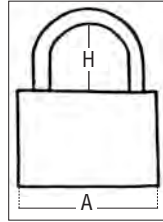

KEY RING

Nickel plated tempered steel. Strong type.

Product number	Outside diameter		Inside diameter		Wire diameter	Pack
	po. / in.	mm	po. / in.	mm		
C2583	5/8"	16	35/64"	14	1.0	100
C2586	3/4"	19	5/8"	16	1.5	100
C2588	1"	25	55/64"	22	1.5	100
C2589	1-1/4"	32	1-3/32"	28	2.0	100



HEAVY SAFETY HASP & STAPLE

ZP, zinc plated steel. Loose staple. In poly bag with bar code.

Product number	Length		Thickness	Box	Pack
	po. / in.	mm			
C617-3	3"	2.0	10	1	
C617-35	3-1/2"	2.0	10	1	
C617-45	4-1/2"	2.0	10	1	
C617-6	6"	2.8	10	1	



SAFETY HASP & STAPLE

Brass plated steel. Screws included.

Product number	Length		Box	Pack
	po. / in.	mm		
C34B2	2"	24	1	
C34B25	2-1/2"	24	1	
C34B3	3"	12	1	



Hardware - Doors & windows, casters

HEAVY «T» HINGE BLACK EPOXY FINISH STEEL.

Screws included.

One pair per poly bag
with bar code.

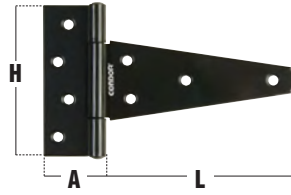

SH209PB

Product number	L	A	H	Gauge	Box	Pack
SH209PB	4"	1-3/16"	3-3/8"	0.09"	10 pr	1 pr
SH211PB	6"	1-3/4"	4-1/2"	0.10"	5 pr	1 pr
SH212PB	8"	2"	5-5/8"	0.10"	5 pr	1 pr
SH213PB	10"	2-1/8"	6-3/16"	0.11"	5 pr	1 pr

HEAVY «T» HINGE ZINC PLATED STEEL.

Screws not included.

One pair per poly bag
with bar code.



SH209ZP

SH209ZP	4"	1-3/16"	3-3/8"	0.09"	10 pr	1 pr
SH211ZP	6"	1-3/4"	4-1/2"	0.10"	5 pr	1 pr
SH212ZP	8"	2"	5-5/8"	0.10"	5 pr	1 pr
SH213ZP	10"	2-1/8"	6"	0.11"	5 pr	1 pr
SH214ZP	12"	2-1/8"	6"	0.11"	4 pr	1 pr

LIGHT «T» HINGE ZINC PLATED STEEL.

Screws not included. One pair
per poly bag
with bar code.

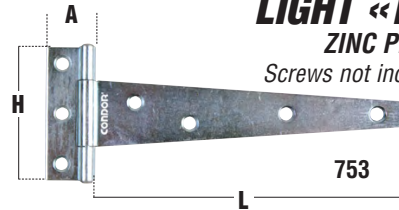

753

753-3	3"	13/16"	2-7/32"	0.056"	10 pr	1 pr
753-4	4"	15/16"	2-7/16"	0.056"	10 pr	1 pr
753-6	6"	1-1/16"	3-1/8"	0.072"	10 pr	1 pr

HEAVY STRAP HINGE BLACK EPOXY FINISH STEEL.

Screws included.

One pair per poly bag
with bar code.

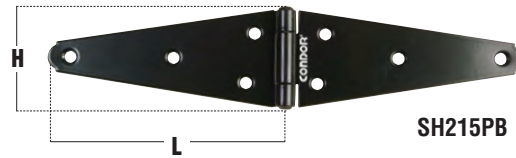

SH215PB

Product number	L	H	Gauge	Box	Pack
SH215PB	4"	1-3/4"	0.09"	10 pr	1 pr
SH217PB	6"	2-3/8"	0.09"	5 pr	1 pr
SH218PB	8"	3-1/8"	0.10"	5 pr	1 pr
SH219PB	10"	3-1/8"	0.11"	5 pr	1 pr

HEAVY STRAP HINGE ZINC PLATED STEEL.

Screws not included. One pair per poly bag
with bar code.



SH215ZP

SH215ZP	4"	1-3/4"	0.09"	10 pr	1 pr
SH217ZP	6"	2-3/8"	0.09"	5 pr	1 pr
SH218ZP	8"	3-1/8"	0.10"	5 pr	1 pr
SH219ZP	10"	3-1/8"	0.11"	5 pr	1 pr
SH220ZP	12"	3-1/2"	0.11"	4 pr	1 pr

LIGHT STRAP HINGE ZINC PLATED STEEL.

Screws not included. One pair per poly bag
with bar code.

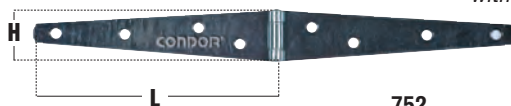

752

752-3	3"	1-1/16"	0.056"	10 pr	1 pr
752-4	4"	1-3/16"	0.056"	10 pr	1 pr
752-6	6"	1-1/2"	0.072"	10 pr	1 pr

Hardware - Doors & windows, casters

SQUARE BUTT BALL BEARING HINGE

Slimline bearing, bright brass plated steel C3, satin nickel plated steel C15, for wooden doors. Screws included.
In box with bar code.

SATIN NICKEL C15

Product number	Size	Gauge	Pack
	po. / in.		
CB848C1533	3" x 3"	0.10"	1 pr
CB848C1535	3-1/2" x 3-1/2"	0.11"	1 pr
CB848C1544	4" x 4"	0.11"	1 pr
CB848C1545	4-1/2" x 4-1/2"	0.15"	1 pr

BRIGHT BRASS C3

CB848SDB33	3" x 3"	0.10"	1 pr
CB848SDB35	3-1/2" x 3-1/2"	0.11"	1 pr
CB848SDB44	4" x 4"	0.11"	1 pr
CB848SDB45	4-1/2" x 4-1/2"	0.15"	1 pr



CB848



SQUARE BUTT BALL BEARING HINGE

Wrought steel, full mortise template type, regular weight, satin nickel finish. 24 machine screws 12-24 x 1/2 in., & 24 wood screws 1-1/4 in. x 12 included.
Three (3) pieces per box with bar code.

SATIN NICKEL

Product number	Size	Gauge	Pack
	po. / in.		
C179C15454	4-1/2" x 4"	0.15"	3 pcs



C179C15454



STAINLESS STEEL SQUARE BUTT HINGE

Stainless steel, satin finish. Full mortise, button tip loose pin. Screws included.
One pair per box with bar code.

Numéro produit Product number	Grandeur Size	Épaisseur Gauge	Emb. Pack
	po. / in.		
C8433	3" x 3"	2.3	1 pr
C8435	3-1/2" x 3-1/2"	2.3	1 pr
C8444	4" x 4"	3.0	1 pr



C8433



«BOMMER»

SPRING LOADED TEMPLATE HINGE

UL and ULC listed for fire door applications, easily adjusted spring tension. Screw holes conform to "ANSI" specifications. Economic choice for door closing device on industrial, commercial or residential applications. Ideal where fire codes require a self closing door, hotel, motel, apartment, condo, etc. Wood and machine screws included.
One pair per box with bar code.









Numéro produit Product number	Grandeur Size	Fini Finish	Emb. Pack
	po. / in.		
C4310C435	3-1/2" x 3-1/2"	LAITON SAT./ BRASS	1 pr
C4310C444	4" x 4"	LAITON SAT./ BRASS	1 pr
C4310C4454	4-1/2" x 4"	LAITON SAT./ BRASS	1 pr
C4310C26D35	3-1/2" x 3-1/2"	CHROME SATIN	1 pr
C4310C26D44	4" x 4"	CHROME SATIN	1 pr
C4310C26D454	4-1/2" x 4"	CHROME SATIN	1 pr



C4310C



RAPCO

			
DIN 1 B	DIN 7	DIN 84	DIN 85
			
DIN 85	DIN 93	DIN 94	DIN 95
			
DIN 97	DIN 125 A	DIN 125 B	DIN 126
			
DIN 127 B	DIN 128 A	DIN 128 A	DIN 137 A/B
			
DIN 186 B	DIN 315	DIN 316	DIN 319
			
DIN 388 C	DIN 432	DIN 433	DIN 434/435
			
DIN 436	DIN 438	DIN 439 B	DIN 440 R
			
DIN 443	DIN 444 B	DIN 462	DIN 463
			
DIN 464	DIN 466	DIN 467	DIN 470
			
DIN 471	DIN 472	DIN 479	DIN 508
			
DIN 529 A	DIN 529 E	DIN 546	DIN 551
			
DIN 553	DIN 555	DIN 557	DIN 558
			
DIN 561 B	DIN 562	DIN 571	DIN 580
			
DIN 582	DIN 601/555	DIN 603	DIN 603/555
			
DIN 604/555	DIN 605/555	DIN 609	DIN 653
			
DIN 660	DIN 661	DIN 662	

KNIVES AND SPECIAL TOOLS





L-1

LB-10 #1051
10 blades in plastic container.
80 snap-off blades.

L-1, L-2, FL, OL,
CL, SL-1, CS-2, AL

LB-50B #1074
50 blades in plastic container.
400 snap-off blades. Blister pak.



H-1











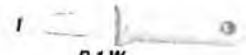



HB-5B #1050
Extra large blade for H-1 cutter.
5 blades per card.

HB-20 #1075
Extra large blade for H-1 cutter.
20 blades per box.

LB-50 #1073
50 blades in plastic container.
400 snap-off blades.

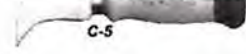
INDUSTRIAL KNIVES

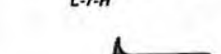

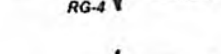
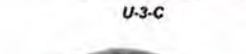
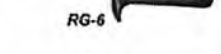
 L-3	 R-1-W
 L-4	 C-1
 L-4-G	 C-2
 L-5	 C-3
 L-6	 C-5
 L-7	 U-1
 L-7-H	 U-3-C
 RG-4	 3120
 RG-6	 2910
 R-1	



726



804



W-2 1/2



18900



WF-564



RW-10



55012



CS-9-13



1209



08076



05560



705



07417



MS-1



102920

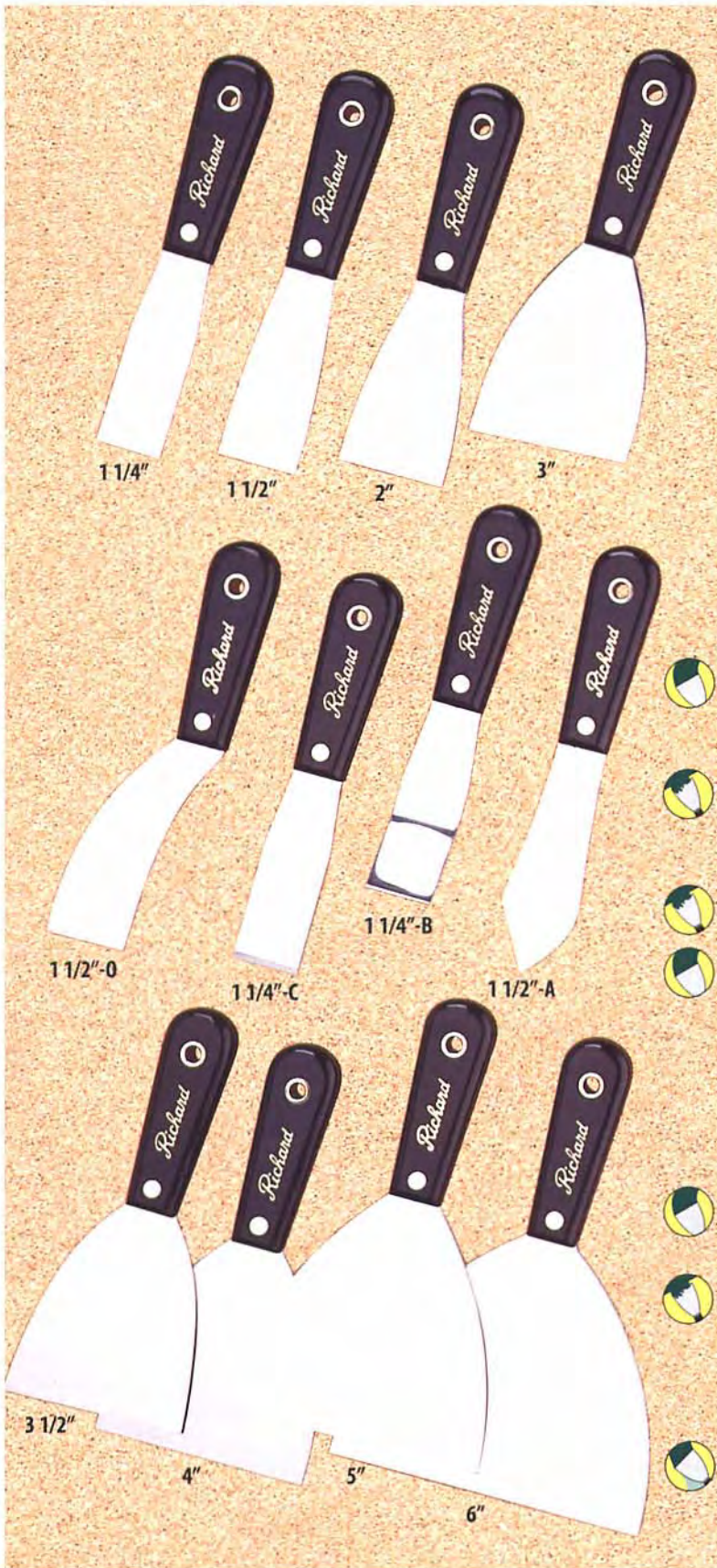

Pro Series

High-carbon steel blades, black polypropylene handles

Description

Internationally known as the standard of quality design and manufacturing, this Pro Series addresses the requirements of a wide selection of craftsmen and home owners and their specific needs.

Features and benefits

- Optimum blade designs, hardness and flexibility, offering reliable, durable, quality workmanship;
- A variety of task-oriented blade designs;
- Flexible blades are ground to provide optimum pliability and even distribution of compounds.

Product knowledge

- High-carbon carbon steel blades, 0.050" to 0.065" thick;
- Full tang blades, heat-treated, tempered, ground, mirror-polished and lacquer-sealed;
- Flexible taping knife blades are hollow ground on both sides;
- Handles are made from solvent-resistant polypropylene.

Item #	Size	Uses
Flexible Putty Knives		
P-1 1/4-F	1 1/4"	Patches small holes and cracks
P-1 1/2-F	1 1/2"	
P-2-F	2"	
Stiff Putty Knives		
P-1 1/4-S	1 1/4"	Scrapes and chips out old putty
P-1 1/2-S	1 1/2"	
P-2-S	2"	
Special Knives		
P-1 1/4-B Bent	1 1/4"	General scraping and cleaning
P-1 1/4-C Chisel	1 1/4"	Scrapes and chips out old putty
P-1 1/2-0 Offset	1 1/2"	Applies drywall compounds with hand clearance
P-1 1/2-A English	1 1/2"	Applies drywall compound for curved and angle surfaces, opens cracks and crevices
Flexible Wall Scrapers		
S-3-F	3"	Applies drywall compounds
S-3 1/2-F	3 1/2"	
Stiff Wall Scrapers		
S-3-S	3"	Scrapes old putty, paint, varnish, etc.
S-3 1/2-S	3 1/2"	
S-4-S	4"	
S-5-S	5"	
S-6-S	6"	
Flexible Taping Knives		
S-4-F	4"	Tapes drywall joints, patches drywall
S-5-F	5"	
S-6-F	6"	

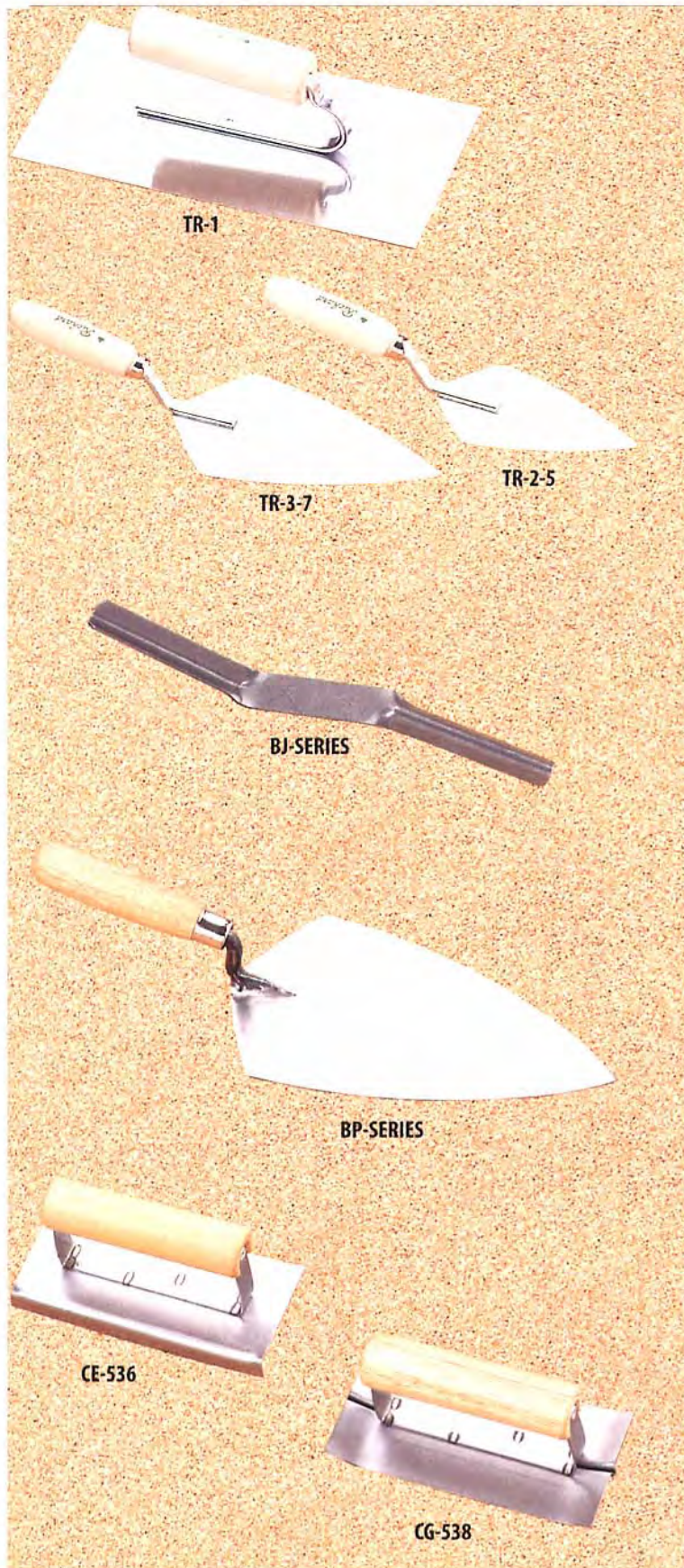

TR Trade, Cement and Pointed Trowel Series

Cement Trowel

- Smooths and finishes cement and finishes drywall.

Item #	Size	Description
TR-1	4 3/4" x 10"	Finishing cement trowel
TR-2-5	5"	Pointed trowel
TR-3-7	7"	Pointed trowel

Sabinox Semi-Professional Series

- Polished cold-rolled steel;
- Cleans and shapes mortar joints between bricks and cement blocks.

Item #	Size	Description
BJ-2	5/8" and 3/4"	Brick jointer
BJ-3	3/8" and 1/2"	Brick jointer

Brick and Pointing Trowels

- High-carbon steel, heat-treated, tempered, ground and polished;
- Hardwood handles;
- Mortars bricks and cement blocks, and points mortar joints.

Item #	Size	Description
BP-209	9"	Brick trowel
BP-210	10"	Brick trowel
BP-211	11"	Brick trowel

Cement Edger and Groover

- Polished spring steel blades;
- Hardwood handle;
- Establishes smooth rounded edges on fresh cement (edger);
- Establishes grooved pattern in fresh cement (groover).

Item #	Size	Description
CE-536	3" x 6"	Cement edger
CG-538	3" x 6"	Cement groover

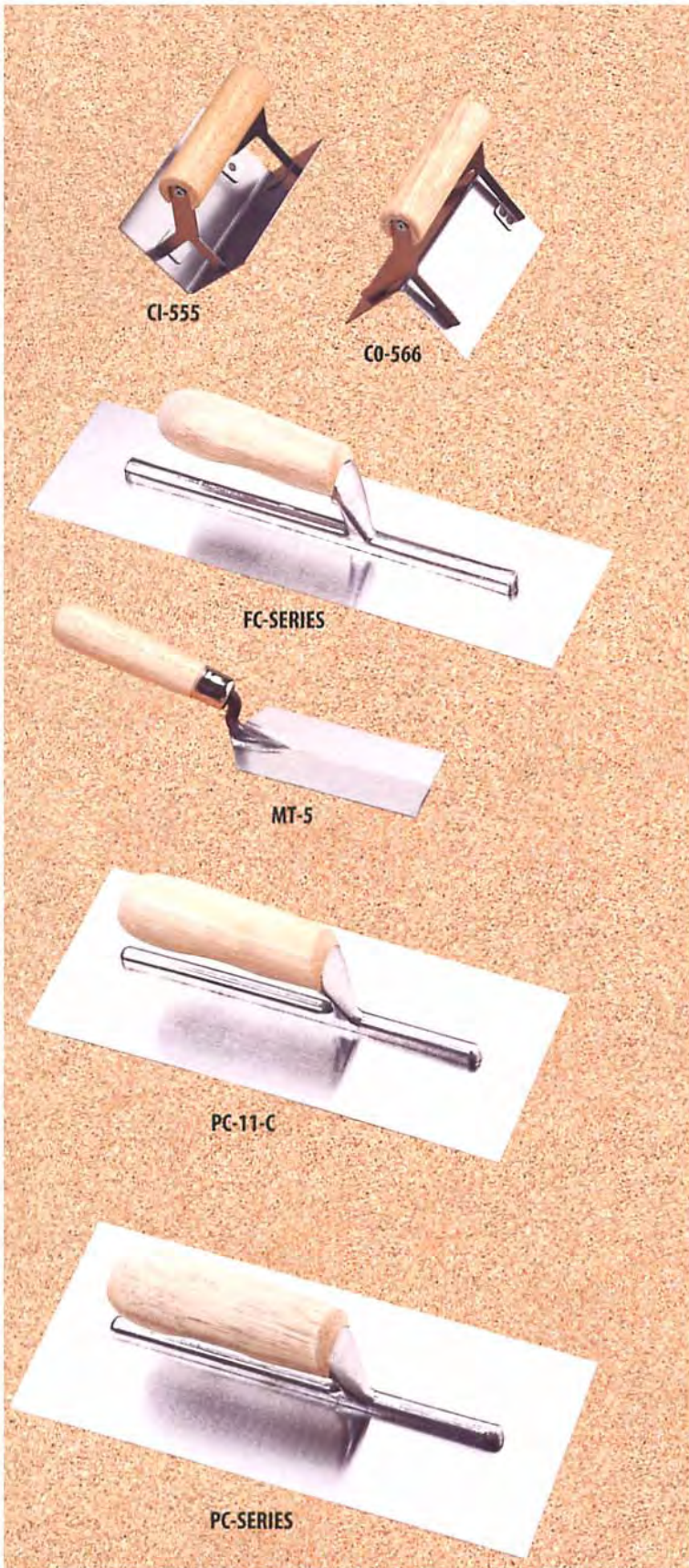

Inside and Outside Corner Cement Trowels

- Polished spring steel blades;
- Hardwood handle;
- Works and smoothes fresh cement surfaces on inside and outside corners.

Item #	Size	Description
CI-555	5" x 2 1/2"	Inside corner trowel
CO-566	5" x 2 1/2"	Outside corner trowel

Finishing Trowels

- High-carbon spring steel;
- Hardwood ergonomic handle;
- Finishes fresh cement surfaces.

Item #	Size	Description
FC-114	14" x 4"	Cement trowel
FC-116	16" x 4"	Cement trowel

Margin Trowel

- High-carbon steel, heat-treated, tempered, ground and polished;
- Hardwood handle;
- Mortars cement blocks on the side.

Item #	Size	Description
MT-5	5" x 2"	Margin trowel

Curved Drywall Trowel

- High-carbon spring steel;
- Hardwood ergonomic handle;
- Finishes drywall.

Item #	Size	Description
PC-11-C	11" x 4 1/2"	Drywall trowel, curved blade

Finishing Trowels

- High-carbon spring steel;
- Ergonomic hardwood handle;
- Finishes fresh cement surfaces or drywall.

Item #	Size	Description
PC-110	10" x 4"	Finishing trowel
PC-111	11" x 4 1/2"	Finishing trowel
PC-112	12" x 4"	Finishing trowel

6 X 2 3/4 Pointing Trowel w/ Wooden Handle

EDI: 11128



- Forged from a single piece of high carbon steel
- Hardwood handle

11 X 4 1/2 Finishing Trowel w/ Straight DuraSoft® Handle

EDI: 12105



- Highest grade hardened and tempered spring steel blade, properly shaped
- Aluminum alloy Xtralite® mounting is lightweight but very strong
- Beveled work edges prevent surface aggregate popping
- Resilient DuraSoft® handle provides a soft feel, reduces fatigue, and offers excellent durability

48 X 8" Round End Magnesium Bull Float w/RotaLeveler®

EDI: 14719



- Made from the finest extruded magnesium available
- Lightweight, long wearing and properly balanced to provide the finish you want
- No other heavy duty bull float outlasts this one
- Round Ends
- Includes a RL6 RotaLeveler

Made in the USA

10' X 1" X 4" - High Strength Aluminum Alloy Screed

EDI: 14780

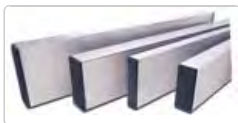

- Premium high strength alloy won't rust or rot; more damage and warp resistant
- End capped to prevent concrete from getting inside
- Lightweight, long wearing and rigid
- WARNING: When using screeds always avoid contact with electrical power lines or any electrical source
- Ships LTL

Made in the USA

5 X 1 1/2 Margin Trowel w/DuraSoft® Handle

EDI: 11205



- Forged from a single piece of high carbon steel
- Tempered, ground, and polished from toe to heel
- Resilient DuraSoft® handle
- U.S. Patents - 5,327,612 & 5,446,941

Made in the USA

16 X 3 1/8" Beveled End Magnesium Hand Floats w/DuraSoft® Handle

EDI: 14610



- Extruded from very hard, durable, lightweight magnesium
- Our most popular float design
- Comfortable handle is positioned to give the tool perfect balance
- Handles are secured with torque pad screws that will not back out
- Recommended for use with air entrained concrete
- Magnesium floats produce a smoother finish than wood
- Resilient DuraSoft® handle provides a soft feel, reduces fatigue, and offers excellent durability

8" X 3 1/2" X 1 1/2" 20-Grit QLT Rub Brick

EDI: 16194



- Fluted 20-grit silicon carbide surface
- Ideal for dressing down and removing form marks from concrete

Monster Pry Bar

EDI: 16595



- All steel construction ensures long life
- Powder coated finish
- 56" length gives enough leverage for even the toughest jobs
- Ideal for prying forms and other embedded objects



TOOLS FOR MASONRY AND DRYWALL



KNEE PADS



BLADERUNNER



TAPING KNIVES



BUTTERING



DUCK-BILL



BRICK



MARGIN



POINTING



TUCKPOINTING



FINISHING TROWELS



POOL TROWELS



GROOVERS-STAINLESS



CA-STYLE FRESNO® TROWEL



MAGNESIUM HAND FLOATS



WOOD FLOATS



MISCELLANEOUS



PLACERS AND RAKES



EDGERS-BRONZE



BULL FLOATS



SCREEDS



BROOMS



GROOVERS-BRONZE



EDGERS-STAINLESS



ADAPTORS/BRACKETS



HANDLES

Legendary Bessey Heat Treated Steel, Sliding Arm Clamps

These clamps offer a greater reach to eliminate the need to buy both regular AND deep throat clamps.

Bessey Heat Treated Steel, Sliding Arm Clamps feature the Patented Morpad – the replaceable pad that tilts to 35°

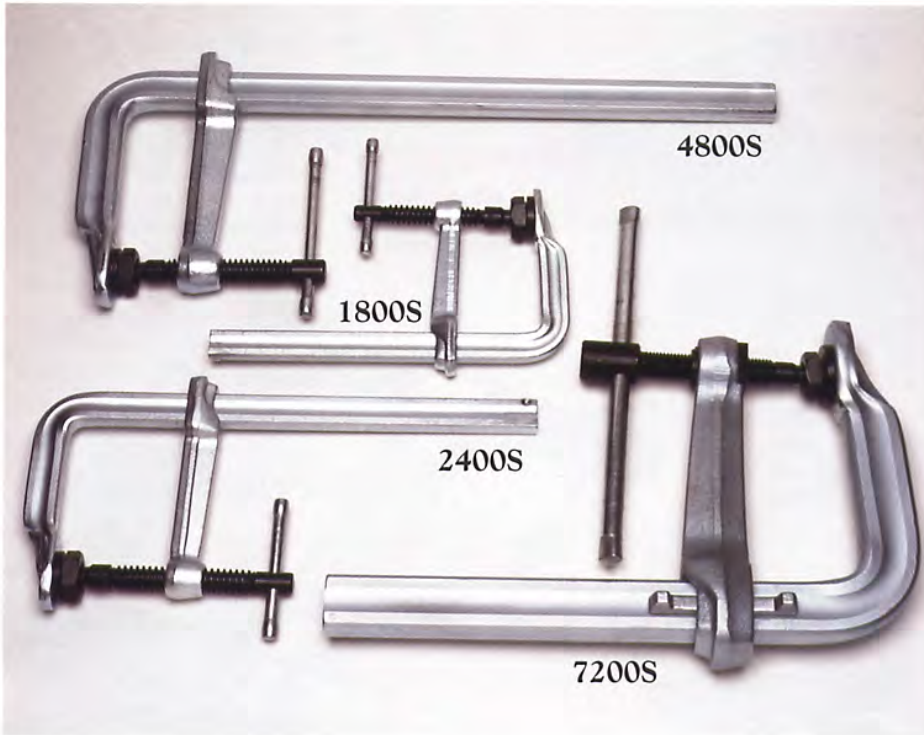

1800 Series MEDIUM DUTY Clamps

- Two sizes – 8" and 12" openings
- 1800 lb. nominal clamping pressure

2400 Series REGULAR DUTY Clamps

- Seven sizes – from 6" to 60" openings
- 2660 lb. nominal clamping pressure

4800 Series HEAVY DUTY Clamps

- for uses such as clamping 3/4" plate
- Five sizes – from 12" to 60" openings
- 4880 lb. nominal clamping pressure

7200 Series EXTRA HEAVY DUTY Clamps

- for uses such as clamping 1" plate
- Safety wedge provides additional locking pressure on sliding arm
- Three sizes – from 12" to 40" openings
- 7770 lb. nominal clamping pressure

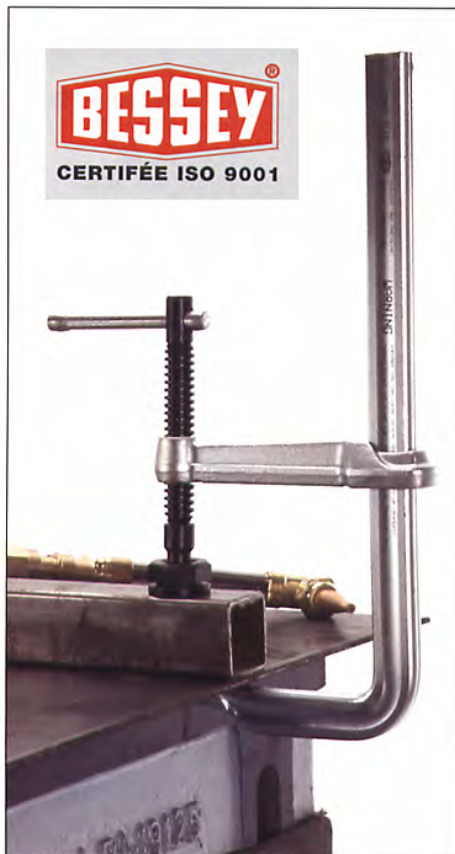

CATALOG NUMBER	NOMINAL OPENING	NOMINAL THROAT DEPTH	NOMINAL CLAMPING PRESSURE	NOMINAL RAIL SIZE	APPROX. WEIGHT
1800 SERIES MEDIUM DUTY CLAMPS – WITH MORPAD					
1800S-8	8"	4 1/4"	1800 LBS.	1 1/16" X 1/2"	4.00 LBS.
1800S-12	12"	4 1/4"	1800 LBS.	1 1/16" X 1/2"	4.75 LBS.
2400 SERIES REGULAR DUTY CLAMPS – WITH MORPAD					
2400S-6	6"	5 1/2"	2660 LBS.	1 3/16" X 9/16"	5.00 LBS.
2400S-8	8"	5 1/2"	2660 LBS.	1 3/16" X 9/16"	5.50 LBS.
2400S-10	10"	5 1/2"	2660 LBS.	1 3/16" X 9/16"	5.75 LBS.
2400S-12	12"	5 1/2"	2660 LBS.	1 3/16" X 9/16"	6.80 LBS.
2400S-20	20"	5 1/2"	2660 LBS.	1 3/16" X 9/16"	7.50 LBS.
2400S-40	40"	5 1/2"	2660 LBS.	1 3/16" X 9/16"	10.75 LBS.
2400S-60	60"	5 1/2"	2660 LBS.	1 3/16" X 9/16"	14.25 LBS.
4800 SERIES HEAVY DUTY CLAMPS – WITH MORPAD					
4800S-12	12"	7"	4880 LBS.	1 3/16" X 1/4"	12.00 LBS.
4800S-20	20"	7"	4880 LBS.	1 3/16" X 1/4"	14.50 LBS.
4800S-40	40"	7"	4880 LBS.	1 3/16" X 1/4"	20.00 LBS.
4800S-48	48"	7"	4880 LBS.	1 3/16" X 1/4"	22.00 LBS.
4800S-60	60"	7"	4880 LBS.	1 3/16" X 1/4"	28.00 LBS.
7200 SERIES EXTRA HEAVY DUTY CLAMPS – WITH MORPAD					
7200S-12	12"	8"	7770 LBS.	1 3/16" X 1"	24.00 LBS.
7200S-20	20"	8"	7770 LBS.	1 3/16" X 1"	28.00 LBS.
7200S-40	40"	8"	7770 LBS.	1 3/16" X 1"	38.00 LBS.

GRAY TOOLS

Mechanics' Vises

Part No.	Jaw Width	Jaw Opening	Jaw Depth	Net Weight (lbs.)
VS3	4"	4¾"	2¾"	33
VS4	4½"	5½"	3"	43
VS5	5"	6½"	3¼"	50
VS6	6"	8"	3¾"	70
VS8	8"	9"	4"	85



C-Clamps

Part No.	Opening Capacity	Throat Depth	Spindle Diameter	Maximum Proof Test, lbs.
C402	0-2"	1¾"	½"	3,500
C403	0-3"	2½"	⅝"	3,500
C404	0-4"	3"	¾"	6,200
C406	0-6"	3⅞"	¾"	6,600
C408	0-8"	4½"	¾"	6,900
C410	0-10"	5"	¾"	8,000
C412	0-12"	5½"	7⁄8"	9,300

Features:

- All C-Clamps are drop forged steel framed.
- Extra throat depth.
- Swivel Perma Pads®.
- Lacquer finish.
- New design frame geometry for maximum strength.
- Forcing screw and pad are plated with copper to resist welding splatter.
- Forcing screw has a sliding T-handle and an impact resistant pad.

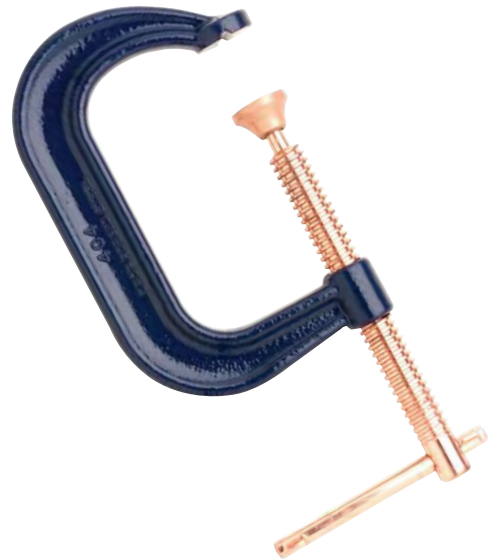

Swivel Pads Replacement

Part No.	Fits C-Clamp Part Number
C402-CAP	C402, C403
C404-CAP	C404, C406, C408
C410-CAP	C410, C412

Bolt Cutters

Overall Part No.	Length	Capacity	Replacement Cutters
BC14	14"	5⁄16"	BC14-CUT
BC18	18"	3⁄8"	BC18-CUT
BC24	24"	7⁄16"	BC24-CUT
BC30	30"	½"	BC30-CUT
BC36	36"	9⁄16"	BC36-CUT

Features:

- All steel tubular handles with rubber grips.
- Lockplate prevents jaw bolts from turning or loosening.
- Eliminates "sloppy" head, ensures trouble free operation.
- Drop forged alloy tool steel jaws with precision ground cutting edges for maximum wear resistance.
- Toggle joint transforms 50 pounds of hand pressure to 4,000 pounds of pressure on cutting edges of jaws.





FOLDING RULES



CUTTING OIL

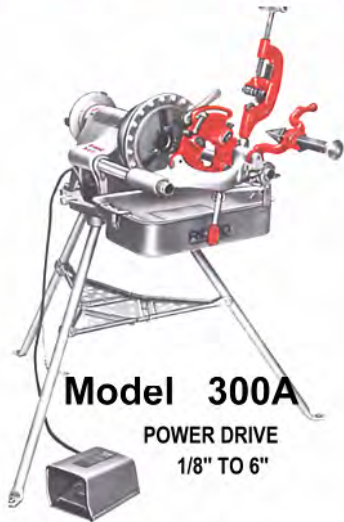

Model 300A
POWER DRIVE
1/8" TO 6"

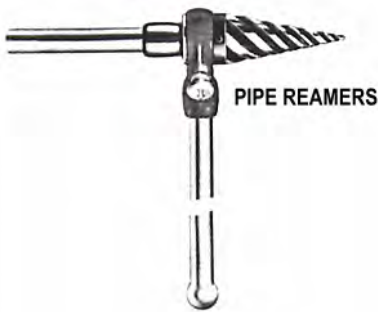

PIPE REAMERS



No. 535

WRENCHES

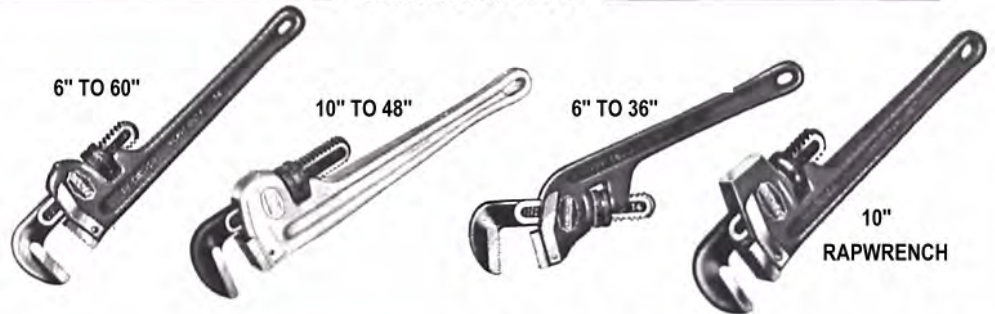

6" TO 60"

10" TO 48"

6" TO 36"

10"
RAPWRENCH

TUBING CUTTERS



TUBING CUTTERS
No. 10,15,20 and 315

QUICK ACTION
1/4" TO 6 5/8"

THREADERS



1/8" to 1 1/4"



1/8" to 2"



1/4" to 1"



No. 504



65R-tc



No. 141
No. 161



No. 30A 3/8" to 3/4"
No. 31A 1/2" to 1"



1/4" to 1"



No. 4PJ

VICES



1/8" TO 8"



1/8" TO 6"



1/8" TO 2 1/2"



1/8" TO 6"

High-Leverage Side-Cutting Pliers – Heavy-Duty Cutting D2000-SNE 2000 SERIES®

Cat. No.	Nose Type	Overall Length	Jaw Length	Jaw Width	Jaw Thickness	Knife Length	Handle Finish	Handle Color	Weight (lbs.)
D2000-7	New England	7-7/8" (200 mm)	1-9/32" (33 mm)	1-1/32" (26 mm)	1/2" (13 mm)	3/4" (19 mm)	plastic-dipped	royal blue	.66
D2000-8	New England	8-11/16" (221 mm)	1-7/16" (37 mm)	1-7/64" (28 mm)	5/8" (16 mm)	3/4" (19 mm)	plastic-dipped	royal blue	.85
D2000-9NE	New England	9-3/8" (238 mm)	1-19/32" (41 mm)	1-1/4" (32 mm)	5/8" (16 mm)	25/32" (20 mm)	plastic-dipped	royal blue	1.09
HD2000-9NE	New England	9-1/2" (241 mm)	1-19/32" (41 mm)	1-1/4" (32 mm)	5/8" (16 mm)	25/32" (20 mm)	heavy-duty, oversized, plastic-dipped	light red	1.15

Journeyman 2000 Series – Dual-material handles

J2000-9NE	New England	9-1/2" (241 mm)	1-19/32" (41 mm)	1-1/4" (32 mm)	5/8" (16 mm)	25/32" (20 mm)	Journeyman	light blue/black	1.13
-----------	-------------	-----------------	------------------	----------------	--------------	----------------	------------	------------------	------

Refer to the insulated section for insulated pliers.



High-Leverage Side-Cutting Pliers

D213-9NE

Cat. No.	Nose Type	Overall Length	Jaw Length	Jaw Width	Jaw Thickness	Knife Length	Handle Finish	Handle Color	Weight (lbs.)
D213-8NE	New England	8-11/16" (221 mm)	1-7/16" (37 mm)	1-3/16" (30 mm)	5/8" (16 mm)	23/32" (18 mm)	plastic-dipped	dark blue	.90
HD213-8NE	New England	8-3/4" (222 mm)	1-7/16" (37 mm)	1-3/16" (30 mm)	5/8" (16 mm)	23/32" (18 mm)	heavy-duty, oversized, plastic-dipped	light red	.97
213-9NE	New England	9-1/4" (235 mm)	1-19/32" (41 mm)	1-1/4" (32 mm)	5/8" (16 mm)	25/32" (20 mm)	plain	n/a	1.05
D213-9NE	New England	9-3/8" (238 mm)	1-19/32" (41 mm)	1-1/4" (32 mm)	5/8" (16 mm)	25/32" (20 mm)	plastic-dipped	dark blue	1.14
HD213-9NE	New England	9-1/2" (241 mm)	1-19/32" (41 mm)	1-1/4" (32 mm)	5/8" (16 mm)	25/32" (20 mm)	heavy-duty, oversized, plastic-dipped	light red	1.15

Journeyman Series – Dual-material handles

J213-9NE	New England	9-1/2" (241 mm)	1-19/32" (41 mm)	1-1/4" (32 mm)	5/8" (16 mm)	25/32" (20 mm)	Journeyman	dark blue/black	1.13
----------	-------------	-----------------	------------------	----------------	--------------	----------------	------------	-----------------	------

Refer to the insulated section for insulated pliers.



D201-9NE

Cat. No.	Nose Type	Overall Length	Jaw Length	Jaw Width	Jaw Thickness	Knife Length	Handle Finish	Handle Color	Weight (lbs.)
Streamlined Design									
D201-6NE	New England	6-5/16" (160 mm)	1-3/32" (28 mm)	29/32" (23 mm)	1/2" (13 mm)	9/16" (14 mm)	plastic-dipped	dark blue	.39
D201-7NE	New England	7-7/16" (189 mm)	1-9/32" (33 mm)	1-1/16" (27 mm)	1/2" (13 mm)	5/8" (16 mm)	plastic-dipped	dark blue	.55
D201-8NE	New England	8-11/16" (221 mm)	1-7/16" (37 mm)	1-3/16" (30 mm)	5/8" (16 mm)	23/32" (18 mm)	plastic-dipped	dark blue	.92
D201-9NE	New England	9-3/8" (238 mm)	1-19/32" (41 mm)	1-5/16" (33 mm)	5/8" (16 mm)	25/32" (20 mm)	plastic-dipped	dark blue	1.09



Ironworker's Work Pliers – High-Leverage

D213-9ST

Cat. No.	Nose Type	Overall Length	Jaw Length	Jaw Width	Jaw Thickness	Knife Length	Handle Finish	Handle Color	Weight (lbs.)
213-9ST	Square	9-1/4" (235 mm)	1-19/32" (41 mm)	1-1/4" (32 mm)	5/8" (16 mm)	25/32" (20 mm)	plain	n/a	1.02
D213-9ST	Square	9-3/8" (238 mm)	1-19/32" (41 mm)	1-1/4" (32 mm)	5/8" (16 mm)	25/32" (20 mm)	plastic-dipped	dark blue	1.10
2000 Series* – Heavy-duty cutting knives									
D2000-9ST	Square	9-3/8" (238 mm)	1-19/32" (41 mm)	1-1/4" (32 mm)	5/8" (16 mm)	25/32" (20 mm)	plastic-dipped	royal blue	1.10
Journeyman 2000 Series® – Dual-material handles									
J2000-9ST	Square	9-3/8" (238 mm)	1-19/32" (41 mm)	1-1/4" (32 mm)	5/8" (16 mm)	25/32" (20 mm)	Journeyman	light blue/black	1.10

*Cuts ACSR, screws, nails, and most hardened wire. Features combination polished and black-oxide finish.



High-Leverage Diagonal-Cutting Pliers

D2000-28

Cat. No.	Overall Length	Jaw Length	Jaw Width	Jaw Thickness	Cutting Knives	Handle Finish	Handle Color	Weight (lbs.)
D228-7	7-1/8" (181 mm)	13/16" (21 mm)	1-3/16" (30 mm)	7/16" (11 mm)	standard	plastic-dipped	red	.54
D228-8	8-1/16" (205 mm)	13/16" (21 mm)	1-3/16" (30 mm)	7/16" (11 mm)	standard	plastic-dipped	red	.60
Journeyman Series – Dual-material handles								
J228-8	8-1/8" (206 mm)	13/16" (21 mm)	1-3/16" (30 mm)	7/16" (11 mm)	standard	Journeyman	red/black	.67
2000 Series* – Heavy-duty cutting knives								
D2000-28	8-1/16" (205 mm)	13/16" (21 mm)	1-3/16" (30 mm)	7/16" (11 mm)	standard	plastic-dipped	royal blue	.60
Journeyman 2000 Series* – Dual-material handles								



Leather-Bottom Buckets

Additional Features:

- No. 1 canvas.
- Leather reinforced bottom.
- Leather cuff extends 3" (76 mm) up the side.
- Inside pocket measures 8" x 8" (203 mm x 203 mm).
- Rope handle.



5104

Cat. No.	Top Diameter	Bottom Diameter	Height	Extra Features	Weight (lbs.)
5104	12" (305 mm)	12" (305 mm)	17" (432 mm)		2.71
5104S	12" (305 mm)	12" (305 mm)	17" (432 mm)	swivel snap (Cat. No. 2012)	2.93

Straight-Wall Buckets

Additional Features:

- No. 6 canvas.
- Black molded polypropylene bottom.
- Rope handle.



5106

Cat. No.	Diameter	Height	Extra Features	Weight (lbs.)
5106	9" (229 mm)	14" (356 mm)		1.51
5106P	9" (229 mm)	14" (356 mm)	two 7" x 7" (178 mm x 178 mm) inside pockets	1.62
5106S	9" (229 mm)	14" (356 mm)	swivel snap (Cat. No. 2012)	1.80

Wide-Opening Straight-Wall Buckets

Additional Features:

- No. 6 canvas.
- Black molded polypropylene bottom.
- Rope handle.

Cat. No.	Diameter	Height	Extra Features	Weight (lbs.)
5109	12" (305 mm)	15" (381 mm)		2.06
5109P	12" (305 mm)	15" (381 mm)	one 8" x 8" (203 mm x 203 mm) inside pocket	2.12
5109S	12" (305 mm)	15" (381 mm)	swivel snap (Cat. No. 2012)	2.35
5109PS	12" (305 mm)	15" (381 mm)	one 8" x 8" (203 mm x 203 mm) inside pocket and swivel snap (Cat. No. 2012)	2.40



5109

Tapered-Wall Buckets

Additional Features:

- No. 6 canvas.
- Black molded polypropylene bottom.
- Rope handle.



5113

Cat. No.	Top Diameter	Bottom Diameter	Height	Extra Features	Weight (lbs.)
5113	12" (305 mm)	9" (229 mm)	13" (330 mm)		1.55
5113S	12" (305 mm)	9" (229 mm)	13" (330 mm)	swivel snap (Cat. No. 2012)	1.84

Heavy-Duty Tapered-Wall Bucket

Additional Features:

- Tough No. 4 canvas.
- Black molded polypropylene bottom.
- Rope handle.
- Riveted leather glove strap.
- Equipped with Cat. No. 2012 swivel snap hook.



5103S

Cat. No.	Top Diameter	Bottom Diameter	Height	Extra Features	Weight (lbs.)
5103S	12" (305 mm)	9" (229 mm)	12" (305 mm)	swivel snap (Cat. No. 2012)	1.95

Tape-Rule Holders



5195

Cat. No.	Description	Overall Size	Weight (lbs.)
5194	small	4" x 6" (102 mm x 152 mm)	.16
5195	medium	4-1/2" x 7" (114 mm x 178 mm)	.18
5196	large	5" x 7" (127 mm x 178 mm)	.21

Bull-Pin Holders

- Leather construction.
- Holders for Klein bull pins.
- Riveted to assure long life.
- Holds all standard bull pins.



5417

5417T

Cat. No.	Belt Connection	Belt Width	Overall Size	Weight (lbs.)
5417	slotted	up to 2" (51 mm)	3-1/4" x 11" (83 mm x 279 mm)	.22
5417T	tunnel	up to 3-1/2" (89 mm)	3-1/4" x 12-1/4" (83 mm x 311 mm)	.32

Erection Wrench Holder

- Cotton web tunnel loop and leather construction.
- Holds two erection wrenches.
- Riveted to assure long life.
- Holds erection wrenches and adjustable head construction wrench Cat. No. 3239.



5461T

Cat. No.	Belt Connection	Belt Width	Overall Size	Weight (lbs.)
5461T	cotton web tunnel	up to 2" (51 mm)	6" x 10" (152 mm x 254 mm)	.26

Erection Wrench Holders

- Leather construction.
- Has tool slots for two erection wrenches.
- Tunnel loop on Cat. No. 5459T is riveted to assure long life.
- Holds erection wrenches and adjustable head construction wrench Cat. No. 3239.



5460

5459T

Cat. No.	Belt Connection	Belt Width	Overall Size	Weight (lbs.)
5460	slotted	up to 2" (51 mm)	6" x 8-1/2" (152 mm x 216 mm)	.19
5459T	tunnel	up to 3-1/2" (89 mm) or to slide over D-rings, buckles, and other accessories	6" x 9-1/2" (152 mm x 241 mm)	.32

Bull-Pin and Bolt Bags

- No. 4 canvas or split-leather with double bottom.
- Bolt bag with bull-pin loop on each side.

Cat. No.	Belt Connection	Belt Capacity	Length	Width	Depth	Weight (lbs.)
Canvas						
5416	loops	up to 3" (76 mm) wide	5" (127 mm)	9" (229 mm)	10" (254 mm)	.85
5416T	tunnel	up to 3" (76 mm) wide	5" (127 mm)	9" (229 mm)	10" (254 mm)	.90



5416

Snap Loop

- Leather construction.
- Designed for tools with hang holes.
- Loop with snap hook for carrying an adjustable wrench, welder's igniter or other tool with hang hole.
- Riveted to assure long life.



5458

Cat. No.	Belt Connection	Belt Width	Overall Size	Weight (lbs.)
5458	slides on	up to 4" (102 mm)	1-1/2" x 8-1/2" (38 mm x 216 mm)	.15

Line-Hose Bag

- No. 6 canvas with Cylolac top ring and molded bottom.
- Large enough to accommodate several pieces of hose.
- Can also be used to raise protective rubber blankets that are rolled.
- Leather cuff extends 3" (76 mm) up the side.
- Polypropylene rope handle is reinforced with leather.



5110-48

Cat. No.	Diameter	Depth	Weight (lbs.)
5110-48	7" (178 mm)	48" (1219 mm)	1.91

Canvas Electrode Bag

- Made of tough No. 4 canvas.
- Heat-resistant, hard leather bottom.
- Web loop for sliding over belt.



5471

Cat. No.	Diameter	Front Depth	Back Depth	Weight (lbs.)
5471	2-1/2" (64 mm)	12" (305 mm)	15-1/2" (394 mm)	.25

Standard Bull Pins **KLEIN**



- Machined from quality alloy steel.
- Standard design offers greater initial economy, but no added protection against mushrooming.

Cat. No.	Top Diameter	Point Diameter	Length	Weight (lbs.)
3251	1-1/16" (27 mm)	3/8" (10 mm)	15" (381 mm)	2.50
3252	1-3/16" (30 mm)	7/16" (11 mm)	15" (381 mm)	3.10
3257	1-1/16" (27 mm)	3/8" (10 mm)	12" (305 mm)	1.70
3258	1-3/16" (30 mm)	7/16" (11 mm)	12" (305 mm)	2.10
3259	1-5/16" (33 mm)	7/16" (11 mm)	12" (305 mm)	2.50
3265	1-1/4" (32 mm)	7/16" (11 mm)	12" (305 mm)	2.50

Broad Head Bull Pins



3255

- Forged, heat-treated bull pin increases efficiency by providing a larger striking surface.

- Below the head, squared-off shoulders have been forged to provide a surface for applying wrench to loosen wedged bull pins. Long, even taper reduces binding and hang-up.

Cat. No.	Top Diameter	Point Diameter	Length	Weight (lbs.)
3255	1-1/4" (32 mm)	5/16" (8 mm)	13-3/4" (349 mm)	2.90
3256	1-1/16" (27 mm)	1/4" (6 mm)	10" (254 mm)	1.60

Pins

Barrel-Type Drift Pins

- Machined from quality alloy steel.
- Tapers are uniform and blend into body diameter.
- Tough, drop-forged steel will properly end-pein in use.
- Heat-treated for strength.
- Black finish for rust resistance.



3261

Cat. No.	Maximum Diameter	Point Diameter	Overall Length	Weight (lbs.)
3260	11/16" (18 mm)	5/16" (8 mm)	7-1/2" (191 mm)	.60
3261	13/16" (21 mm)	7/16" (11 mm)	8" (203 mm)	.85
3262	15/16" (24 mm)	1/2" (13 mm)	8" (203 mm)	1.10
3263	1-1/16" (27 mm)	9/16" (14 mm)	8" (203 mm)	1.50

Construction Wrenches

Adjustable-Head Construction Wrench

- Versatile wrench fits nuts and bolts to 1-1/2" (38 mm).
- Eliminates the need for carrying several fixed-size wrenches.
- Forged from select alloy steel with continuous-taper handle for aligning bolt and/or rivet holes.
- Industrial black finish for corrosion resistance.



3239

Cat. No.	Max. Size Capacity	Length	Weight (lbs.)
3239	1-1/2" (38 mm)	16" (406 mm)	2.30

1/2"-Drive Ratcheting Construction Wrench

- Accepts 1/2" square-drive hex socket.
- Reversible ratchet.
- Eliminates the need for carrying several fixed-size wrenches.
- Forged from select alloy steel with continuous-taper handle for aligning bolt and/or rivet holes.
- Industrial black finish for corrosion resistance.



3238

Cat. No.	Overall Length	Weight (lbs.)
3238	15" (381 mm)	2.10

Erection Wrenches

- Forged from select alloy steel to withstand high-leverage and heavy loads.



3231

Cat. No.	Nut Type	Bolt Size	Nom. Opening	Head Width	Taper Diameter	Overall Length	Weight (lbs.)
3210	U.S. heavy	1/2"	7/8"	2-1/4"	7/8" to 3/16"	14-3/4"	1.36
3211	U.S. heavy	5/8"	1-1/16"	2-1/4"	7/8" to 3/16"	14-3/4"	1.31
3212	U.S. heavy	3/4"	1-1/4"	2-1/2"	1" to 1/4"	16-5/8"	1.98
3213	U.S. heavy	7/8"	1-7/16"	3"	1-1/8" to 9/32"	17-3/8"	2.72
3214	U.S. heavy	1"	1-5/8"	3-5/8"	1-1/8" to 1/4"	18"	3.36
3219	U.S. regular	1/2"	3/4"	2-1/4"	7/8" to 8/16"	14-3/4"	1.36
3220	U.S. regular	1/2"	13/16"	2-1/4"	7/8" to 3/16"	14-3/4"	1.35

Cat. No.	Nut Type	Bolt Size	Nom. Opening	Head Width	Taper Diameter	Overall Length	Weight (lbs.)
3221	U.S. regular	5/8"	1"	2-1/4"	7/8" to 3/16"	14-3/4"	1.31
3222	U.S. regular	3/4"	1-1/8"	2-1/2"	1" to 1/4"	16-5/8"	2.00
3223	U.S. regular	7/8"	1-5/16"	3"	1-1/8" to 9/32"	17-3/8"	2.87
3224	U.S. regular	1"	1-1/2"	3-5/8"	1-1/8" to 1/4"	18"	3.37
3231	utility	5/8"	15/16"	2-1/4"	7/8" to 3/16"	14-3/4"	1.31
3232	utility	3/4"	1-1/16"	2-1/2"	1" to 1/4"	16-5/8"	2.00

Tie-Wire Reel

- Rugged, lightweight reel is smooth aluminum alloy with wear parts made of steel.
- Feeds pre-coiled wire smoothly, easily, and quickly to save time and reduce wasted wire.
- Designed for left- or right-hand use.
- Large, comfortable rewind knob.
- Easily-removed cover plate that permits quick, convenient reloading to handle all types of wire.
- Optional accessory rigging-**leather** belt and hip pad available separately.



27400

Cat. No.	Diameter	Width	Weight (lbs.)
27400	6-1/4" (159 mm)	2-25/32" (71 mm)	2.35

Ironworker's heavy-duty tie-wire belts available. Tie-wire pad available.

Rebar Shear

- Top-loading 3/4" (19 mm) heavy-duty shear cuts up to and through #6 rebar.
- Easily replaceable tool-steel knives and heavy steel construction for long tool life.
- Includes mounting bolts, and removable steel handle. Does not include wooden platform.



64302K

Cat. No.	Handle Length	Shear Height	Shear Width	Shear Length	Weight (lbs.)
64302K	60" (152 cm)	6" (152 mm)	6" (152 mm)	13" (330 mm)	50.00

Replacement Cutting Blades

64321	pair of cutting blades for Cat. No. 64302K				.75
-------	--	--	--	--	-----

Rebar Hickeys



64308

- Lightweight rebar hickey has exceptionally durable steel-alloy head and extra-strong handle to withstand punishing service conditions.

Cat. No.	Hickey Size	Bends Rebar Size	Head Type and Bending Angle	Handle Length	Weight (lbs.)
64308	1	nos. 3 (.375" dia.), 4 (.500" dia.)	single 65°	24" (610 mm)	2.50
64309	1a	nos. 3 (.375" dia.), 4 (.500" dia.)	double 65° and 90°	24" (610 mm)	3.50
64310	2	no. 5 (.625" dia.)	single 65°	40" (1016 mm)	7.50
64311	3	no. 6 (.750" dia.)	single 65°	40" (1016 mm)	8.00
64312	4	nos. 7 (.875" dia.), 8 (1.00" dia.), 9 (1.128" dia.)	single 65°	60" (1524 mm)	16.40

Grizzly® Bar



64306

- A heavy, strong, multi-purpose tool that saves time and effort on the job.
- The 3" (76 mm) width protects concrete when stripping forms.
- Efficient blade angle and 55-1/2" (141 cm) total length provide high leverage as a crow bar and nail and spike puller.
- Blade is forged and hardened alloy with keyhole nail-pulling slot in center and V-notch in tapered edge.
- Very efficient nail-pulling tool even in awkward positions.
- Can be used to help align walls during tilt-up construction, to roll and align large pipe, to remove shingles and flooring, and for many other stripping and prying tasks.

Cat. No.	Overall Length	Weight (lbs.)
64306	55-1/2" (1410 mm)	12.00

All dimensions are in inches and (millimeters).

▲WARNING: Always wear approved personal protective equipment.

▲WARNING: Always wear approved eye protection.

▲WARNING: Do NOT exceed rated capacity for rebar shear and rebar hiccys.

NON-SPARKING SAFETY TOOLS

BARS & NAIL PULLERS



With fire always posing a risk to work-place safety, employers should conduct regular assessments for potential hazards. Fire requires four things; fuel, heat, oxygen, and a self-sustaining chemical reaction. Because our work environments are filled with both fuel and heat sources, the fundamentals of ALL fire prevention, is to keep heat separated from fuels and fuels separated from heat. Unfortunately, sparks created by steel tools are often overlooked as an ignition source (heat); therefore,

Non-Sparking Hand Tools are often overlooked as a Fire Prevention Means!

HAMMERS



SAWS



PLIERS

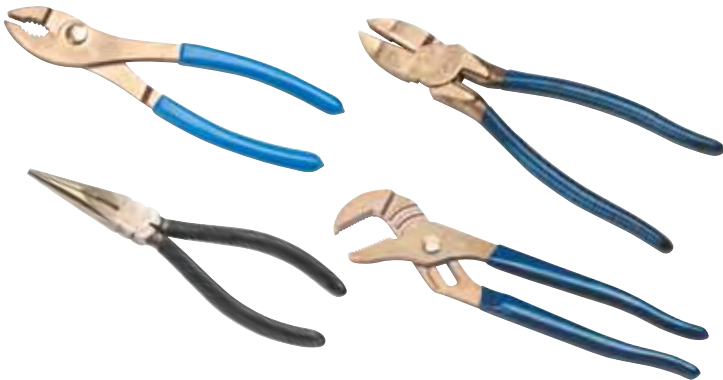

ADJUSTABLE WRENCHES



PIPE WRENCHES

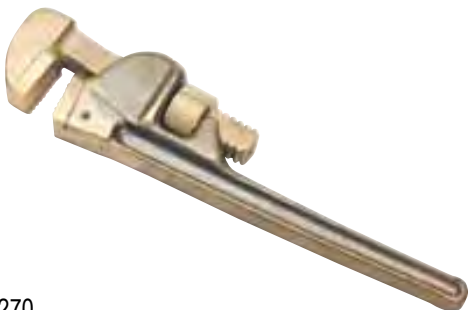

SNIPS

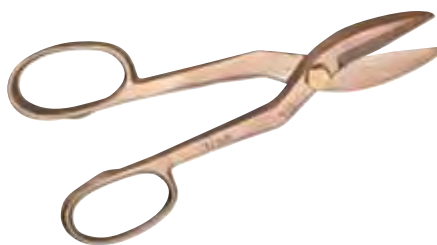

CHISELS

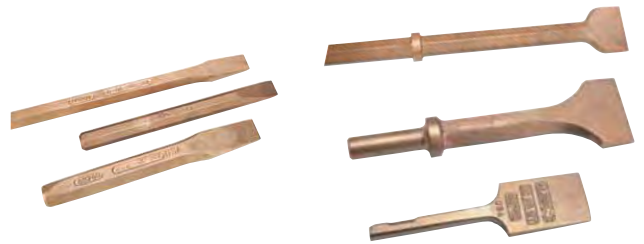

PICKS



AXES



COMBINATION WRENCHES



Utility Cabinets

2-DOOR UTILITY CABINET



5660L

- Open storage for shovels, picks, brooms and other long-handled tools. (Model 5660LH only)
- Patented, ergonomically designed fold-down recessed handles.
- Recommend #1 and #5 Masterlock padlocks or equivalent.

		CAPACITY			DIMENSIONS													WEIGHT	
CAT. NO.	UPC NO.	FT ³	A	B	C	D	E	F	G	H	I	J	K	L	M	N	O	LBS.	kg
5660L	38659	46	56"	60"	24"	15"	10.5"	11.5"	10"	10"	2"	14"	3"	23.5"	20.5"	50.5"	24"	401	182
5660LH	07486	46	56"	60"	24"	15"	10.5"	11.5"	10"	10"	2"	14"	3"	23.5"	20.5"	50.5"	24"	408	185
5760	38722	58.3	56"	60"	30"	15"	10.5"	11.5"	10"	10"	2"	14"	3"	23.5"	23.5"	50.5"	24"	437	198
5760TD	07969	59.3	56"	60"	30"	15"	10.5"	11.5"	10"										

Flat-Top Boxes



- Flat-top design provides more storage capacity for tall, bulky items, plus a large work surface for jobsite plans.
- Recessed and concealed lock protector inhibits forced entry and corrosion to lock.
- Channel reinforcements on lid, lock side panels into lid for added security when closed.
- Hinged lower shelf allows for easy storage of larger objects (except Model 3360).

		CAPACITY			DIMENSIONS										WEIGHT	
CAT. NO.	UPC NO.	FT ³	A	B	C	D	E	F	G	H	I	J	K	L	LBS.	kg
3360	38719	34.5	33"	60"	30"	—	12.5"	12"	20"	—	—	—	—	—	256	116
4848	35043	40	48"	48"	30"	11"	7"	12"	27"	2"	3"	17"	—	—	292	132
4860	35057	50	48"	60"	30"	11"	7"	12"	27"	2"	3"	17"	—	—	305	138
4872	07487	60	48"	72"	30"	11"	7"	12"	27"							

Slant-Top Boxes



3660

- Large capacity storage with traditional slant-top design.
- Recessed and concealed lock protectors provide maximum security against drilling and cutting locks.
- Channel reinforcements on lid, lock side panels into lid for added security when closed.
- Hinged lower shelf enables storage of larger items.
- Hemmed (reinforced) high-strength shelves.
- Continuous, non-removable hinge pins help prevent theft.
- Strategically located, easily accessible, durable gas-shocks provide for ease in opening lid (except Model 2260).
- New angled 3-1/2" high support skids feature threaded holes for easy

		CAPACITY			DIMENSIONS							WEIGHT	
CAT. NO.	UPC NO.	FT ³	A	B	C	D	E	F	G	H	LBS.	kg	
2260	23270	32	22"	60"	32"	36"	12"	12"	21"	—	228	103	
3648	23276	34	36"	48"	30"	48"	5"	12"	27"	11"	273	124	
3660	23196	44	36"	60"	30"	48"	5"	12"	27"	11"	282	128	

Welder's Boxes



1531

small tools and supplies.

Single lock hasp for use with padlock.

- Compact side handles for easy portability.
- Heavy-duty hinges, plus chain connector to hold lid in open position.
- Recommend #1 and #5 Masterlock padlocks or equivalent.

		DIMENSIONS				WEIGHT	
CAT. NO.	UPC NO.	CAPACITY FT ³	HEIGHT	WIDTH	DEPTH	LBS.	kg
1230	31510	3.3	12"	30"	16"	48	21.8
1531	23274	4.5	15"	31"	18"	51	23.1

Steel Fish Tapes



SPECIFICATIONS

Capacity	1/8" (3.2 mm) tape width- 400 lbs. (1.7 kN) maximum design strength	
	1/4" (6.4 mm) tape width – 400 lbs. (1.7 kN) maximum design strength.	
	438-5H - 1/8" (3.2 mm) tape width- 400lbs. (1.7 kN) maximum design strength.	
Weight	R438-5 - 1.8 lbs. (0.8 kg)	438-5H – 2.75 lbs. (1.3 kg)
	R438-10 - 3.3 lbs. (1.5 kg)	438-5 - 2.75 lbs. (1.2 kg)
	R438-20 - 6.2 lbs. (2.8 kg)	438-10 - 5 lbs. (2.3 kg)
	R538-10 – 6 lbs. (2.7 kg)	438-20 - 7lbs. (3.2 kg)
	R538-20 – 11 lbs. (5 kg)	538-10 – 8 lbs. (3.6 kg)

www.greenlee.com

CAT. NO.	UPC NO.	DESCRIPTION
438-5H	07500	50' × 1/8" × 0.045" (15.2 m × 3.2 mm × 1.1 mm) Steel Fish Tape in Winder Case
438-5	29045	65' × 1/8" × 0.060" (19.8 m × 3.2 mm × 1.5 mm) Steel Fish Tape in 8 1/2" Winder Case
438-5BP	00170	65' × 1/8" × 0.060" (19.8 m × 3.2 mm × 1.5 mm) Steel Fish Tape in 8 1/2" Winder Case, 5-pack
438-10	28256	125' × 1/8" × 0.060" (38.1 m × 3.2 mm × 1.5 mm) Steel Fish Tape in 12" Winder Case
438-10BP	00171	125' × 1/8" × 0.060" (38.1 m × 3.2 mm × 1.5 mm) Steel Fish Tape in 12" Winder Case, 5-pack
438-20	29046	240' × 1/8" × 0.060" (73.2 m × 3.2 mm × 1.5 mm) Steel Fish Tape in 12" Winder Case
438-20BP	00172	240' × 1/8" × 0.060" (73.2 m × 3.2 mm × 1.5 mm) Steel Fish Tape in 12" Winder Case, 5-pack
538-10	30394	100' × 1/4" × 0.060" (30.5 m × 6.4 mm × 1.5 mm) Steel Fish Tape in 12" Winder Case
R438-5	29047	65' × 1/8" × 0.060" (19.8 m × 3.2 mm × 1.5 mm) Steel Fish Tape without Winder Case
R438-10	28257	125' × 1/8" × 0.060" (38.1 m × 3.2 mm × 1.5 mm) Steel Fish Tape without Winder Case
R438-20	29048	240' × 1/8" × 0.060" (73.2 m × 3.2 mm × 1.5 mm) Steel Fish Tape without Winder Case
R538-10	30395	100' × 1/4" × 0.060" (30.5 m × 6.4 mm × 1.5 mm) Steel Fish Tape without Winder Case
R538-20	30396	200' × 1/4" × 0.060" (61 m × 6.4 mm × 1.5 mm) Steel Fish Tape without Winder Case, must be used without winder

Screw-Type Reel Stands

- Wide, welded steel base for added stability with 5/8" holes.
- Roller bearings fit in the spindle groove to keep the spindle in place and turning freely.
- Two stands and a spindle are required for a complete setup.



Light-Duty Basket-Type Pulling Grips

CAT. NO.	UPC NO.	CABLE DIAMETER RANGE		MAXIMUM RATED CAPACITY		EYE LENGTH		MESH LENGTH	
		INCH	mm	LBS.	kN	INCH	mm	INCH	mm
STANDARD									
30536	30536	.50 - .61	12.7 - 15.5	560	2.5	5	127	16	406.4
30538	30538	.62 - .74	15.6 - 18.9	560	2.5	5	127	16	406.4
30540	30540	.75 - .99	19.0 - 25.3	800	3.5	6	152.4	20	508
30542	30542	1.00 - 1.24	25.4 - 31.5	1360	6	7	177.8	20	508
30544	30544	1.25 - 1.49	31.6 - 38	1360	6	7	177.8	21	533.4
30546	30546	1.50 - 1.99	38.1 - 50.7	1360	6	8	203.2	23	584.2
30548	30548	2.00 - 2.49	50.8 - 63.4	1700	7.5	9	228.6	25	635
30550	30550	2.50 - 2.99	63.5 - 76.1	2120	9.4	9	228.6	27	685.8
30552	30552	3.00 - 3.49	76.2 - 88.8	2940	13	10	254	30	762
30554	30554	3.50 - 3.99	88.9 -						



T-Basket-Type Pulling Grips

CAT. NO.	UPC NO.	CABLE DIAMETER RANGE		MAXIMUM RATED CAPACITY		EYE LENGTH		MESH LENGTH	
		INCH	mm	LBS.	kN	INCH	mm	INCH	mm
SHORT									
30558	30558	.50 - .61	12.7 - 15.5	900	4	8	203.2	21	533.4
30560	30560	.62 - .74	15.6 - 18.9	1120	4.9	8	203.2	24	610
30562	30562	.75 - .99	19.0 - 25.3	1360	6	9	228.6	24	610
30564	30564	1.00 - 1.49	25.4 - 38.0	1920	8.7	9	228.6	24	610
30566	30566	1.50 - 1.99	38.1 - 50.7	3280	14.5	11	279.4	24	610
30568	30568	2.00 - 2.49	50.8 - 63.3	3700	16.4	12	304.8	24	610
30570	30570	2.50 - 2.99	63.5 - 76.1	4900	21.7	12	304.8	24	610
30572	30572	3.00 - 3.49	76.2 - 88.8	4900	21.7	14	355.6	24	610
30574	30574	3.50 - 3.99	88.9 - 101.3	6200	27.5	14	355.6	26	660.4
STANDARD									
30576	30576	.75 - .99	19.0 - 25.3	1360	6	9	228.6	36	914.4
30578	30578	1.00 - 1.49	25.4 - 38.0	1920	8.7	9	228.6	36	914.4
31010	31010	1.50 - 1.99	38.1 - 50.7	3280	14.5	11	279.4	36	914.4
30580	30580	2.00 - 2.49	50.8 - 63.3	3700	16.4	12	304.8	36	914.4
31012	31012	2.50 - 2.99	63.5 - 76.1	4900	21.7	12	304.8	36	914.4
30582	30582	3.00 - 3.49	76.2 - 88.8	4900	21.7	14	355.6	36	914.4
31014	31014	3.50 - 3.99	88.9 - 101.3	6200	27.5	14	355.6	40	1016



Swivels

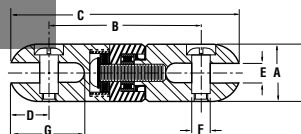

- Helps eliminate winding and tangling of rope and cable during pull.
- Connects grip and pulling rope.
- All stainless steel body construction.
- Efficient thrust and roller bearing construction allows smooth rotation, even under full load.
- Clevis pins are "shoulder bolt" style, so load on both sides of clevis is taken on the shoulder, not on the thread.
- Select the swivel with a maximum rated capacity that meets or exceeds the cable puller's maximum pulling force.

CAT. NO.	UPC NO.	MAXIMUM RATED CAPACITY		A		B		C		D		E		F		G		WEIGHT		REPLACEMENT* PIN KIT UPC NO.
		LBS.	kN	INCH	mm	INCH	mm	INCH	mm	INCH	mm	INCH	mm	INCH	mm	INCH	mm	LBS.	kg	
39106	39106	2,250	11.1	7/8	22.2	2-5/8	66.7	3-1/2	88.9	7/16	11.1	3/8	9.5	5/16	7.9	31/32	24.6	.4	.16	39112
39107	39107	5,000	22.2	1-1/4	31.8	3-1/16	77.8	4-1/8	104.5	17/32	13.5	1/2	12.7	13/32	10.3	1-9/32	32.5	1.0	.45	39113
39108	39108	7,000	31.1	1-3/8	34.9	3-9/32	83.3	4-17/32	115.1	5/8	15.9	9/16	14.3	1/2	12.7	1-3/8	34.9	1.0	.45	39114
39109	39109	10,000	44.4	1-5/8	41.3	3-15/16	100	5-7/16	138.1	3/4	19.1	5/8	15.9	5/8	15.9	1-23/32	43.7	2.0	.91	39115
39110	39110	15,000	66.7	2	50.8	4-11/16	119.1	6-9/16	166.7	15/16	23.8	3/4	19.1	11/16	17.5	2	50.8	4.0	1.81	39116
39111	39111	25,000	111.2	2-3/8	60.3	5-11/16	144.5	8-7/16	214.3	1-3/16	30.2	1	25.4	7/8	22.2	2-25/32	70.6	7.0	3.18	39117

* Replacement Pin Kits contain two (2) Replacement Pins

ARCH PUNCHES



Code:	Inch	mm	Code:	Inch	mm	Code:	Inch	mm
791-2.5	3/32"	2.5	791-18	11/16"	18	791-37	1-7/16"	37
791-3	1/8"	3	791-19	3/4"	19	791-38	1-1/2"	38
791-4	5/32"	4	791-21	13/16"	21	791-40	1-9/16"	40
791-5	3/16"	5	791-22	7/8"	22	791-41	1-5/8"	41
791-6	7/32"	6	791-24	15/16"	24	791-45	1-3/4"	45
791-7	1/4"	7	791-25	1"	25	791-47	1-7/8"	47
791-8	5/16"	8	791-27	1-1/16"	27	791-51	2"	51
791-10	3/8"	10	791-29	1-1/8"	29	791-54	2-1/8"	54
791-11	7/16"	11	791-30	1-3/16"	30	791-58	2-1/4"	58
791-13	1/2"	13	791-32	1-1/4"	32	791-64	2-1/2"	64
791-14	9/16"	14	791-34	1-5/16"	34	791-67	2-5/8"	67
791-16	5/8"	16	791-35	1-3/8"	35	791-70	2-3/4"	70

HIP

NO.802 BEARGRIP 3-JAW RIVETER



- 3-jaw system resists clogging
- Does NOT split inner tube when rivet is set
- Steel & aluminium rivets up to 3/16"
- 3 tips: 1/8", 5/32", 3/16"
- Replacement parts available



NO. 812



- 3-jaw system resists clogging
- Does NOT split inner tube when rivet is set
- Steel & aluminium rivets up to 3/16"
- 4 tips: 3/32", 1/8", 5/32", 3/16"
- Replacement parts available

Code:	Inch/mm	Code:	Inch/mm	Code:	Inch/mm
1025-1.5	1/16" / 1.5 mm	1025-5	3/16" / 5 mm	1025-12	1/2" / 12 mm
1025-2	5/64" / 2 mm	1025-6	1/4" / 6 mm	1025-15	5/8" / 15 mm
1025-3	3/32" / 3 mm	1025-8	5/16" / 8 mm	1025-18	3/4" / 18 mm
1025-4	1/8" / 4 mm	1025-10	3/8" / 10 mm		

Code:	Inch/mm	Code:	Inch/mm	Code:	Inch/mm
1025-1.5	1/16" / 1.5 mm	1025-5	3/16" / 5 mm	1025-12	1/2" / 12 mm
1025-2	5/64" / 2 mm	1025-6	1/4" / 6 mm	1025-15	5/8" / 15 mm
1025-3	3/32" / 3 mm	1025-8	5/16" / 8 mm	1025-18	3/4" / 18 mm
1025-4	1/8" / 4 mm	1025-10	3/8" / 10 mm		

10" RATCHET CABLE CUTTER 1 1/4" CAPACITY IN COPPER AND ALUMINUM



NO. 2105



Code:	2105-6	2105-7	2105-8
Size :	6"	7"	8"

NO. 805



- 3-jaw system resists clogging
- Does NOT split inner tube when rivet is set
- Steel & aluminium rivets up to 1/4"
- 5 tips: 3/32", 1/8", 5/32", 3/16", 1/4"
- Replacement parts available

PORTABLE BANDS **Starrett®**

Dimensions			Teeth per Inch	BI-METAL		To Fit
Length	Width	Thick-ness		Cat. No.	EDP No.	

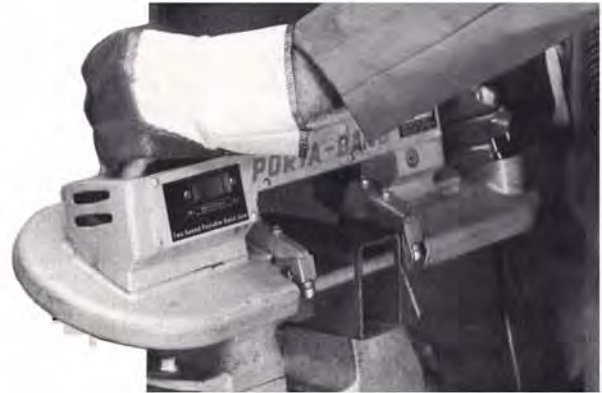

GREENSTRIPE® SAFE-FLEX® HIGH SPEED STEEL

Hardened high speed steel teeth coupled with a tough, shock-absorbing back make this blade shatter resistant for user safety.

Length x Width x Thickness, inches	Teeth Per Inch	Catalog Number	EDP Number
10 x 1/2 x .025	18	SF1018	40028
	24	SF1024	40029
	32	SF1032	40030
12 x 1/2 x .025	14	SF1214	40031
	18	SF1218	40032
	24	SF1224	40033
	32	SF1232	40034

Packing: 100 Blades per Box - 10 Bundles - 10 Blades per Bundle

Fiberglass Long-Line Measuring Tapes Nos. 535, 533 Series
with open reel
50, 100, 150, 200, 300' /
15, 30, 50 m



ControLok®

Automatic Lock-and-Retract Measuring Tapes



SERIES 1000 TAPES

SERIES 2000 TAPES

ULTRALOK

Lufkin



Model No.	Blade Width	Length
1012	1/2	12
1312	3/4	12
1316	3/4	16
1325	3/4	25
1425	1	25
HV1433	1	33
1023CME	1/2	10/3 m
1024CME	1/2	13/4 m
1034CME	3/4	13/4 m
1035CME	3/4	16/5 m
1048CME	1	25/7.6 m
HV1410CME	1	33/10 m
1035ME	3/4	16/5 m
1038ME	3/4	26/8 m



Model No.	Blade Width	Length
2212	1/2	12
2312	3/4	12
2316	3/4	16
2325	3/4	25
2125	1	25
2130	1	30
2024CME	1/2	13/4 m
2034CME	3/4	13/4 m
2033CME	3/4	10/3 m
2035CME	3/4	16/5 m
2048CME	1	25/7.6 m



Model No.	Blade Width	Length
SV125	1	25
SV48CME	1	26/8 m



Model No.	Blade Width	Length
HV15CME	3/8	50/15 m
HV30CME	3/8	100/30 m



Model No.	Blade Width	Length
HY1715CME	1/2	50/15 m
HY1730CME	1/2	100/30 m
HY1750CME	1/2	164/50 m
HY17100CME	1/2	330/100 m

LARGE MEASURING WHEELS

- Large wheel ideal for rough terrain or flat surfaces
- Dial indicator measures up to 9999' 11" without resetting
- Retractable handle adjusts for user comfort
- Measure as fast as you can walk
- Rubber wheel with tough plastic hub

Model No.	Measure	Markings
MW3B	Imperial	in/ft.
MW3BM	Metric	dm/m

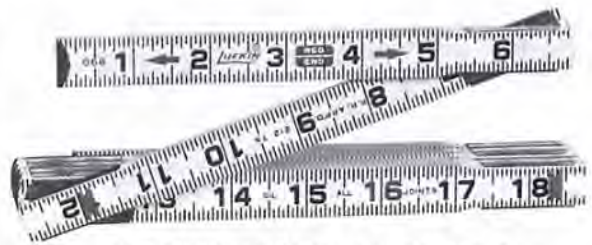

NO. 062CME WOODEN FOLDING RULES
5/8 X 6'

GENERAL®



376

SHALLOW POT CERAMIC MAGNETS

- Shallow depth permits use in confined spaces.
- Nos. 376A and 376B have 3/16" diameter clearance holes for fastening with rods or bolts.
- Nos. 376C and 376D have 9/32" diameter clearance holes.

UPC CODE	NO.	DIA.	DEPTH	PULL
42111 1	376A	1-3/8"	3/16"	12 lbs.
42114 2	376B	2"	1/4"	20 lbs.
42117 3	376C	2-5/8"	3/8"	35 lbs.
42120 3	376D	3-1/4"	7/16"	50 lbs.

372



BUTTON TYPE ALNICO MAGNETS

- Button shaped magnet has almost unlimited applications.
- Retrieves screws and steel parts.
- Center hole in top of magnet for easy fastening.

UPC CODE	NO.	DIA.	HT.	PULL	CORED HOLE
42073 2	372A	1/2"	3/8"	1-1/2 lbs.	1/8"
42076 3	372B	3/4"	1/2"	4 lbs.	1/8"
42079 4	372C	1"	5/8"	6-1/2 lbs.	3/16"
42082 4	372D	1-1/4"	3/4"	14 lbs.	3/16"
42085 5	372E	1-1/2"	7/8"	18-1/2 lbs.	1/4"



16me

MULTI USE RULE AND GAGE

- One of our most popular pocket tools performs five separate and distinct functions.
- Drill point gage is used for checking 59° angle drill points.
- Bevel protractor is used for measuring and laying out angles.
- Center finder locates centers of shafts or circles.
- Circle divider (up to nine equal parts) is used for dividing circles into sectors, regular polygons and polygrams.
- Tap and drill table shows popular tap sizes with correct drill sizes for National form of thread.
- Made of long-wearing stainless steel.
- 4" rule has etched graduations in 64ths and millimeters.

UPC CODE	NO.
22015 8	16me

33-725 - 25' x 1-1/4" FatMax® Tape Rule Reinforced with Blade Armor™ Coating



Features and Benefits

- 11' tape standout
- 1-1/4" wide blade for easy readability
- BladeArmor™ coating on the first 6" maximizes durability of hook end
- Mylar® polyester film extends life of entire blade
- High-impact ABS case with rubber over mold is jobsite tough
- Top-forward blade lock makes locking and unlocking a cinch
- 16" and 19.2" stud center markings simplify framing jobs
- Cushion grip provides comfortable, slip-resistant hold
-

33-726 - 8m/26' x 1-1/4" FatMax® Metric/Fractional Tape Rule Reinforced with Blade Armor™ Coating



Features and Benefits

- 11' tape standout
- 1-1/4" wide blade for easy readability
- BladeArmor™ coating on the first 6" maximizes durability of hook end
- Mylar® polyester film extends life of entire blade
- High-impact ABS case with rubber over mold is jobsite tough
- Top-forward blade lock makes locking and unlocking a cinch
- 16" and 19.2" stud center markings simplify framing jobs
- Cushion grip provides comfortable, slip-resistant hold
-

33-730 - 30' x 1-1/4" FatMax® Tape Rule Reinforced with Blade Armor™ Coating



Features and Benefits

- 11' tape standout
- 1-1/4" wide blade for easy readability
- BladeArmor™ coating on the first 6" maximizes durability of hook end
- Mylar® polyester film extends life of entire blade
- High-impact ABS case with rubber over mold is jobsite tough
- Top-forward blade lock makes locking and unlocking a cinch
- 16" and 19.2" stud center markings simplify framing jobs
- Cushion grip provides comfortable, slip-resistant hold
-

33-735 - 35' x 1-1/4" FatMax® Tape Rule Reinforced with Blade Armor™ Coating



Features and Benefits

- 11' tape standout
- 1-1/4" wide blade for easy readability
- BladeArmor™ coating on the first 6" maximizes durability of hook end
- Mylar® polyester film extends life of entire blade
- High-impact ABS case with rubber over mold is jobsite tough
- Top-forward blade lock makes locking and unlocking a cinch
- 16" and 19.2" stud center markings simplify framing jobs
- Cushion grip provides comfortable, slip-resistant hold
-

33-740 - FatMax® 40' Tape Rule

Features and Benefits

- The world's longest self-retracting tape rule
- Gives the professional the length of a long tape with the versatility of a spring retractable hand tape
- 11' tape standout
- 1-1/4" wide blade for easy readability
- Mylar® polyester film extends life of the entire blade
- Top-forward blade lock makes locking and unlocking a cinch
- Cushion grip provides comfortable, slip-resistant hold



33-835 - 35' x 1" PowerLock® Tape Rule



- 7' standout
- Easy readability with 1" wide blade
- Entire blade coated with Mylar® polyester film for added durability
- Heat-treated spring stands up to repeated use
- 16" and 19.2" stud center markings simplify framing jobs
- Three-rivet, corrosion-resistant hook moves for accurate inside/outside measurements
- Secure blade lock won't creep during measurements
-

33-695 - Stanley® MAX® 5M/16' x 3/4" Tape Measure with AirLock™



Features and Benefits

- Mylar polyester film extends life of entire blade
- The all rubber patented AirLock™ slide lock is easier to engage and adds protection against impact
- High impact ABS in easy to see yellow has cushion grip for a comfortable, slip resistant hold
- Three rivet, corrosion resistant true zero hook moves accurately to allow for precise inside/outside measurements
- Easy to read, high contrast blade with 16" and 19.2" stud markings
-

34-791 - 30m/100' Open Reel Fiberglass Long Tape Rule (Metric/English)



Features and Benefits

- 1/2" wide blade with easy-to-read markings for more accurate measurements
- High-impact ABS case withstands rugged conditions
- PVC blades allow tape to be wound wet and easily cleaned
- Blade is printed on both sides with fractional/decimal, metric/English formats for versatility
- Rubber grip is designed with comfort in mind
- High-visibility color makes it easy to find in the toolbox or on the job site

Blade Length 30m/100'

Blade Width 1/2"

34-794 - 60m/200' Open Reel Fiberglass Long Tape Rule

Features and Benefits

- Fiberglass reinforced PVC tape for less stretch
- Blades made with PVC, tape can be wound wet and easily cleaned
- Two-sided printing with multiple formats
- High impact ABS case with rubber over-mold
- High visibility color makes it easy to find on the job site

Height 11-3/4", 298.45mm

Length 8", 203.2mm

Width 2-3/4", 69.85mm

Weight 2.125 lbs, 0.96 kilos

Blade Length 60m/200'

Blade Width 1/2"

Expert • Light Weight Extruded Aluminum Levels



Catalog Number	Description	Length	Number of vials
40-0200	Aluminum line level	3"	1
40-0202	Plastic line level	3"	1
40-0203	Cross-check level	3"	2

Catalog Number	Length	Number of vials
40-0086	24"	3
40-0088	28"	3
40-0089	36"	3
40-0090	48"	3
40-0092	72"	4

Torpedo Levels



Catalog Number	Length	Number of vials
40-0208	9"	3
40-0210	9"	3
40-0215	9"	3
40-0216	9"	3



Combination Squares

Catalog Number	Size	Head Material	Graduations
40-0536	12"	ABS plastic	1/8", 1/16", 1/32"/mm
40-0540	12"	Zinc	1/8", 1/16", 1/32"/mm

Carpenter and Rafter Squares

Catalog Number	Size	Material	Type
40-0522	16"x24"	Steel	Carpenter
40-0524	16"x24"	Steel	Rafter
40-0526	16"x24"	Steel	Metric Carpenter
40-0528	16"x24"	Aluminum	Carpenter
40-0530	16"x24"	Aluminum	Rafter
40-0532	16"x24"	Aluminum	Rafter
40-0534	8"x12"	Steel	Carpenter
40-0552	-	Brass	Stair Gauges

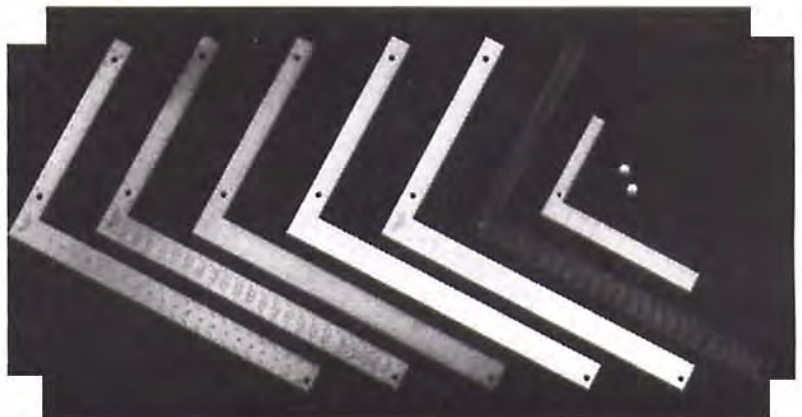

45-500 - Steel Carpenter's Squares (English)



Features and Benefits

- High-quality hardened steel for durability and long life
- Embossed graduations for easy reading on face and back
- Reverse reading scale makes measuring more efficient
- Treated with a clear, protective finish that resists rust

Body Length 24" x 2
Finish Buffed
Graduation-Back 1/8"
Graduation-Face 1/8
Tongue Length 16" x 1-1/2

46-028 - 12" English/Metric Combination Square



Features and Benefits

- Durably etched, hard-chrome-plated blades are rust resistant and made to last
- 12" square has precision-machined working surfaces for improved accuracy
- Built-in scribe comes in handy for surface marking
- Easy-to-read vial
- High-visibility yellow, die-cast handle with brass hardware for durability

Overall Length 305mm, 12"

46-209 - 8" Solid Hardwood Try Square



Features and Benefits

- Durable, etched, stainless-steel 8" blade is coated to resist rust
- 1/16" graduations
- Solid hardwood handle is lacquer-coated for protection
- Comes with durable brass face plates

Blade 203mm, 8
Blade Width 1-1/2
Handle Length 136mm, 5-3/8

46-222 - 12" Combination Square



Features and Benefits

- Embossed hard-chrome blade is coated to resist rust
- Built-in scribe comes in handy for surface marking
- Easy-to-read vial
- Durable, black die-cast metal handle

Overall Length 305mm, 12"



42-465 - 9" Magnetic Cast Aluminum Torpedo Level



Features and Benefits

- Durable, heavy-duty, cast aluminum frame features large, top-read vial window
- Tinted 360° vials make reading easy on the eyes
- Pipe groove enables use on rounded surfaces
- Magnetic strip allows hands-free operation on metal surfaces

Number of Vials 3

42-480 - 48" Professional I-Beam Level



Features and Benefits

- Heavy-duty aluminum I-beam construction provides rigidity and accuracy
- Level accuracy of 0.0015 in./in. (0.15mm/m)
- 360° vials set directly into frame never need adjustment
- Large, clear acrylic vial covers and top-read center vial ease readability
- Yellow powder-coated body with high-visibility accents easy to spot on job site
- Magnetic versions available with silver anodized finish
- Full-length magnetic strip (on magnetic versions) allows for hands-free operation on metal surfaces
- Pipe groove enables use on rounded surfaces
- Shock-absorbing end caps hold up to heavy use
- Hang hole simplifies storage
- Comfortable hand holes for easy handling

Length 48",1219.2mm

Number of Vials 3

42-486 - 48" Magnetic Professional I-Beam Level



Features and Benefits

- Heavy-duty aluminum I-beam construction provides rigidity and accuracy
- Level accuracy of 0.0015 in./in. (0.15mm/m)
- 360° vials set directly into frame never need adjustment
- Large, clear acrylic vial covers and top-read center vial ease readability
- Yellow powder-coated body with high-visibility accents easy to spot on job site
- Magnetic versions available with silver anodized finish
- Full-length magnetic strip (on magnetic versions) allows for hands-free operation on metal surfaces
- Pipe groove enables use on rounded surfaces
- Shock-absorbing end caps hold up to heavy use
- Hang hole simplifies storage
- Comfortable hand holes for easy handling

Length 48",1219.2mm

Number of Vials 3

42-240 - 24" Professional I-Beam Level



Features and Benefits

- Heavy-duty aluminum I-beam construction provides rigidity and accuracy
- Level accuracy of 0.0015 in./in. (0.15mm/m)
- 360° vials set directly into frame never need adjustment
- Large, clear acrylic vial covers and top-read center vial ease readability
- Yellow powder-coated body with high-visibility accents easy to spot on job site
- Magnetic versions available with silver anodized finish
- Full-length magnetic strip (on magnetic versions) allows for hands-free operation on metal surfaces
- Pipe groove enables use on rounded surfaces
- Shock-absorbing end caps hold up to heavy use
- Hang hole simplifies storage
- Comfortable hand holes for easy handling

Length 24",609.6mm

Number of Vials 3



42-244 - 24" Magnetic Professional I-Beam Level

Features and Benefits



- Heavy-duty aluminum I-beam construction provides rigidity and accuracy
- Level accuracy of 0.0015 in./in. (0.15mm/m)
- 360° vials set directly into frame never need adjustment
- Large, clear acrylic vial covers and top-read center vial ease readability
- Yellow powder-coated body with high-visibility accents easy to spot on job site
- Magnetic versions available with silver anodized finish
- Full-length magnetic strip (on magnetic versions) allows for hands-free operation on metal surfaces
- Pipe groove enables use on rounded surfaces
- Shock-absorbing end caps hold up to heavy use
- Hang hole simplifies storage
- Comfortable hand holes for easy handling

Length 24", 609.6mm

Number of Vials 3

42-287 - 3-3/32" Aluminum Line Level

Features and Benefits



- Aluminum construction is lightweight and durable
- Special hang hooks grip line which enables level to slide freely for positioning
- Flat base is ideal for surface leveling
- 360° vial for easy readability

Length 3-3/32", 78.58mm

Number of Vials 1

42-291 - 8" Magnetic Torpedo Level

Features and Benefits



- High impact ABS plastic
- Top reading feature allows greater visibility
- One level plumb and 45° vial
- Magnetic strip

Length 8"

Number of Vials 3

43-679 - 78" FatMax® Xtreme™ Box Beam Level

Features and Benefits



- Durable Box-beam construction is up to 5x stronger than other Stanley® levels
- Block vials provide accuracy of 0.0005 in/in (0.5mm/m)
- Magnified center vial for improved visibility
- Machined leveling surfaces improves accuracy
- Rare earth magnets, which are twice as strong as basic strip magnets, are built into the level for stability
- Lifetime Accuracy Warranty

Length 78"



47-973 - 8 oz. Brass Plumb Bob



Features and Benefits

- Polished-lacquer, solid-brass construction is durable and rust resistant
- Replaceable, hardened steel tip is long-lasting
- Screw top simplifies attaching string to center of plumb (8oz. size comes with an extra tip)
- Thru hole ensures easy tightening

Size 8 oz., 226 gr.

47-974 - 16 oz. Brass Plumb Bob



Features and Benefits

- Polished-lacquer, solid-brass construction is durable and rust resistant
- Replaceable, hardened steel tip is long-lasting
- Screw top simplifies attaching string to center of plumb
- Thru hole ensures easy tightening

Height 1-1/2"

Length 6"

Width 1-1/2"

Weight 1 lbs

51-942 - 16 oz. FatMax® AntiVibe® Rip Claw Nail Hammer

Features and Benefits

- Patented tuning fork design reduces harmful vibration that can cause wrist and arm injuries
- Forged, one-piece steel construction for increased strength and durability
- Rim temper reduces incidences of chipping or spalling
- Ergonomically designed grip reduces fatigue and allows for multiple grip positions
- Texture is molded into each grip for increased comfort and performance even when wet
- Complete range of nailing and framing hammers available



Overall Length 338mm, 13-5/16"

51-943 - 20 oz. FatMax® AntiVibe® Curve Claw Nail Hammer

Features and Benefits

- Patented tuning fork design reduces harmful vibration that can cause wrist and arm injuries
- Forged, one-piece steel construction for increased strength and durability
- Rim temper reduces incidences of chipping or spalling
- Ergonomically designed grip reduces fatigue and allows for multiple grip positions
- Texture is molded into each grip for increased comfort and performance even when wet
- Complete range of nailing and framing hammers available



Overall Length 338mm, 13-5/16"



55-515 - 12" Wonderbar® Pry Bar



WONDER BAR®

Features and Benefits

- Forged, high-carbon steel for increased strength and durability
- Heat-treated for increased durability
- Polished and beveled cutting edges
- Contoured bar makes pulling nails, prying, lifting and scraping easier
- Beveled nail slot at both ends
- High-Visibility, powder-coated finish

Blade Width 44mm, 1-3/4"

Overall Length 314mm, 12-3/8"

55-525 - 15" Super Wonder Bar® Pry Bar



WONDER BAR®

Features and Benefits

- Forged, high-carbon steel for increased strength and durability
- Heat-treated for increased durability
- Polished and beveled cutting edges
- Patented, arched center gives more swing during nail pulling – no need for a wood block
- Tight radius on bend angle aids in positioning bar
- Extended tongue improves grip and reach in hard-to-get-at places
- Excellent for use as a foot-levered, hands-free panel lift
- High-Visibility, powder-coated finish

Blade Width 44mm, 1-3/4"

Overall Length 395mm, 15-1/2"

55-818 - Offset Pattern Ripping Chisel



Features and Benefits

- Extra wide claw
- Beveled nail slot

Cutting Edge 43mm, 1-11/16"

Overall Length 432mm, 17"

Stock Size 17mm, 11/16"

20-065 - 26" Blade Length x 12 Points Per Inch SharpTooth™ Fine Finish Saw



SHARPTOOTH™

Features and Benefits

- Multi-purpose saw for a high quality finish
- For use on laminate, plastic pipe, and all wood types
- SharpTooth™ Saw Technology uses three cutting surfaces to cut 50% faster than conventional Stanley® Hand Saws
- Induction hardened teeth stay sharp 3 to 5 times longer than standard teeth
- Hardwood handle

Blade Length 660mm, 26"

Points per Inch 12

11-911A - 100-Pack 1991® Regular Duty Utility Blades with Dispenser



284

Features and Benefits

- Regular-duty utility blade for light sheet materials, paper and cardboard
- Fits most standard utility knives

Length 2", 50.8mm

Packed 100/Dispenser

Thickness .017"

1991®



FULLER HAMMERS

Designed for general purpose usage, FULLER offers an extensive line of Tubular, Fiberglass & Wood handle Hammers.

TUBULAR HANDLE HAMMERS

Product No.	Description	Box/ Carton
600-3116	16 Oz. tubular claw hammer	4/24

FULLER brand tubular hammers feature a hardened steel shaft, semi-polished, heat-treated head and a suede grip handle.



FIBERGLASS HANDLE HAMMERS

Product No.	Description	Box/ Carton
600-3316	16 Oz. blue fiberglass claw hammer	4/24

FULLER brand fiberglass hammers feature a shock absorbing fiberglass handle, semi-polished heat-treated head, and a suede grip handle.



HARDWOOD HANDLE HAMMERS

Product No.	Description	Box/ Carton
600-4107	7 Oz. hardwood handle claw hammer	6/36
600-4116	16 Oz. hardwood handle claw hammer	6/36

FULLER brand wood handle hammers feature a natural colour hardwood handle and a durable semi-polished heat-treated head.



WOOD HANDLE HAMMERS

Product No.	Description	Box/ Carton
600-4216	16 Oz. wood handle claw hammer	6/36



SPECIALTY HAMMERS

Product No.	Description	Box/ Carton
600-6016	5 Oz. tack hammer	6/36



RUBBER MALLETS

Product No.	Description	Box/ Carton
605-0972	16 Oz. black rubber mallet	6/24
605-0975	32 Oz. black rubber mallet	6/24
605-0977	16 Oz. white rubber mallet	3/12
605-0978	32 Oz. white rubber mallet	6/24

FULLER offers an extensive line of hardwood handle rubber mallets, in both black and non-marking white rubber heads.

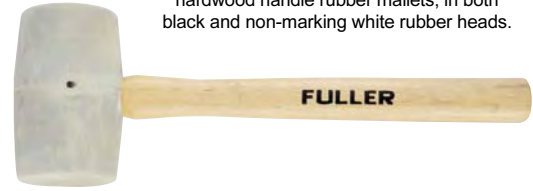

DEAD BLOW HAMMERS

Product No.	Description	Box/ Carton
605-9008	8 Oz. dead blow hammer	4/24
605-9016	16 Oz. dead blow hammer	4/24
605-9024	24 Oz. dead blow hammer	4/12
605-9032	32 Oz. dead blow hammer	4/12

All FULLER Dead Blow Hammers come in Hi-Vis orange colour.



BALL PEEN HAMMERS

Product No.	Description	Box/ Carton
611-4008	8 Oz. ball peen hammer	6/36
611-4016	16 Oz. ball peen hammer	6/36
611-4024	24 Oz. ball peen hammer	6/36
611-4032	32 Oz. ball peen hammer	4/24
611-4040	40 Oz. ball peen hammer	6/24

FULLER Pro Ball Peen Hammers feature kiln-dried hickory shafts.



PRO

CAMPER'S AXE

Product No.	Description	Box/ Carton
610-7220	20 Oz. tubular camper's axe	6/36

The FULLER brand axe features an extra large head, heat-treated to hold its edge. Hardened tubular steel shaft and deluxe grip will provide years of satisfying service. A protective vinyl sheath protects the axe when not in use.



PRO

PRY AND SCRAPER BARS

Product No.	Description	Size	Box/ Carton
615-5513	All purpose pry bar	7-1/2"x7/8"	1/10
615-5514	Pry and scraper bar	9-1/2"x1-3/4"	1/5
615-5515	Heavy duty pry bar	13-1/2"x2"	1/5

FULLER pry and scraper bars are made of the highest quality heat-treated carbon steel, with a baked paint finish. Edges are specially beveled for pulling, lifting and scraping.



NAIL SETS AND CENTER PUNCH

Product No.	Description	Box/ Carton
620-0132	1/32" Nail set	5/30
620-0133	2/32" Nail set	5/30
620-0134	3/32" Nail set	5/30
620-0135	1/8" Center punch	5/30
620-0136	4 Piece nail sets and center punch	5/30

FULLER nail sets are made of hardened and tempered alloy steel. Tips are cupped for self-centering of nail, and tapered to minimize surface damage. The center punch features a chamfered tip to minimize surface damage.



FULLER CUTTING PLIERS

FULLER brand Pliers are designed as a general purpose line of tools, engineered specifically for the homeowner and light industrial usage. Look to the FULLER brand for affordable quality.

DIAGONAL CUTTING PLIERS

Product No.	Length	Box/ Carton
406-1905	5"	5/30
406-1906	6"	5/30
406-1907	7"	5/30

For cutting wire close to the surface.
The tapered head allows clearance for the user's knuckles.



LONG NOSE CUTTING PLIERS

Product No.	Length	Box/ Carton
406-1925	5"	5/30
406-1926	6"	5/30
406-1928	8"	5/30

For gripping small objects in confined spaces.
For twisting and forming thin wire and metal.



LINESMAN PLIERS

Product No.	Length	Box/ Carton
406-1947	7"	5/30
406-1948	8"	5/30

For bending, gripping, and cutting. For the home and workshop.



END CUTTING NIPPER

Product No.	Length	Box/ Carton
406-1956	6"	5/30

For cutting wire and small nails close to the surface.
The head is designed to provide maximum strength and leverage.



FULLER PRO NUT DRIVERS

FULLER PRO Nut Drivers are particularly suited for working with deep seated nuts. Its deep hexagon socket ensures a sure grip every time.

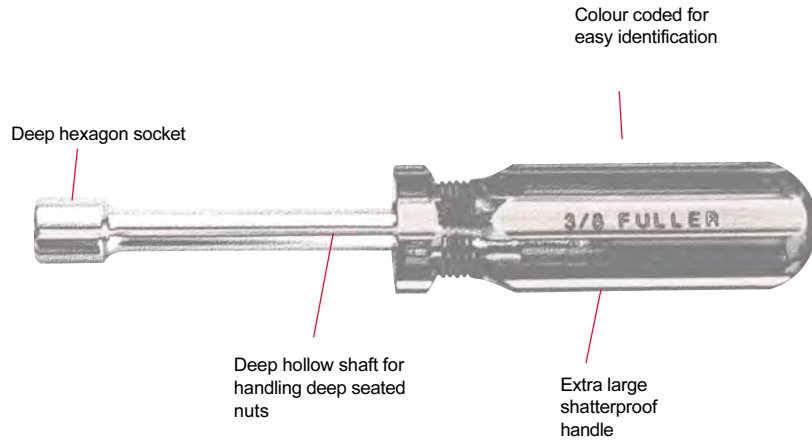

NUT DRIVERS

Product No.	Hex Size	Colour Code	Shaft Length	Box/ Carton
115-0210	3/16"	Black	3-1/4"	5/30
115-0211	1/4"	Red	3-1/4"	5/30
115-0212	5/16"	Yellow	3-1/4"	5/30
115-0213	11/32"	Green	3-1/4"	5/30
115-0214	3/8"	Blue	3-1/4"	5/30
115-0215	7/16"	Brown	3-1/4"	5/30
115-0216	1/2"	Red	3-1/4"	5/30



NUT DRIVER SETS

Product No.	Description	Contents	Box/ Carton
116-0214	4 Piece nut driver set	1/4", 5/16", 3/8", 7/16"	5



MECHANIC'S SCREWDRIVERS

Product No.	Tip Width	Blade Length	Box/ Carton
100-0500	1/4"	1-1/2"	5/30
100-0501	1/4"	4"	5/30
100-0502	1/4"	5"	5/30
100-0503	1/4"	6"	5/30
100-0504	5/16"	6"	5/30
100-0505	3/8"	8"	5/30

PHILLIPS[§] TIP SCREWDRIVERS

Product No.	Tip No.	Blade Length	Box/ Carton
100-0804	0	3"	5/30
100-0807	1	3-1/4"	5/30
100-0808	2	4"	5/30
100-0809	2	1-1/2" Stubby	5/30
100-0811	3	6"	5/30

SQUARE TIP SCREWDRIVERS (2 PIECE TIP)

Product No.	Tip No.	Blade Length	Box/ Carton
100-1009	0	4"	5/30
100-1011	1	4"	5/30
100-1012	2	4"	5/30
100-1013	3	4"	5/30
100-1010	1	1-1/2" Stubby	5/30
100-1014	2	1-1/2" Stubby	5/30
100-1015	3	1-1/2" Stubby	5/30

TORX[†] SCREWDRIVERS

Product No.	TORX Size	Blade Length	Box/ Carton
100-0615	T15	3-1/2"	5/30

TACK PULLER

Product No.	Blade Length	Box/ Carton
100-1490	4"	5/30

SCRATCH AWL

Product No.	Blade Length	Box/ Carton
100-0985	2-3/4"	5/30



§ Registered trademark of Phillips Screw Company.

† Registered trademark of Camcar Division of Textron Inc.

618 PC. FRACTIONAL/METRIC MASTER SET

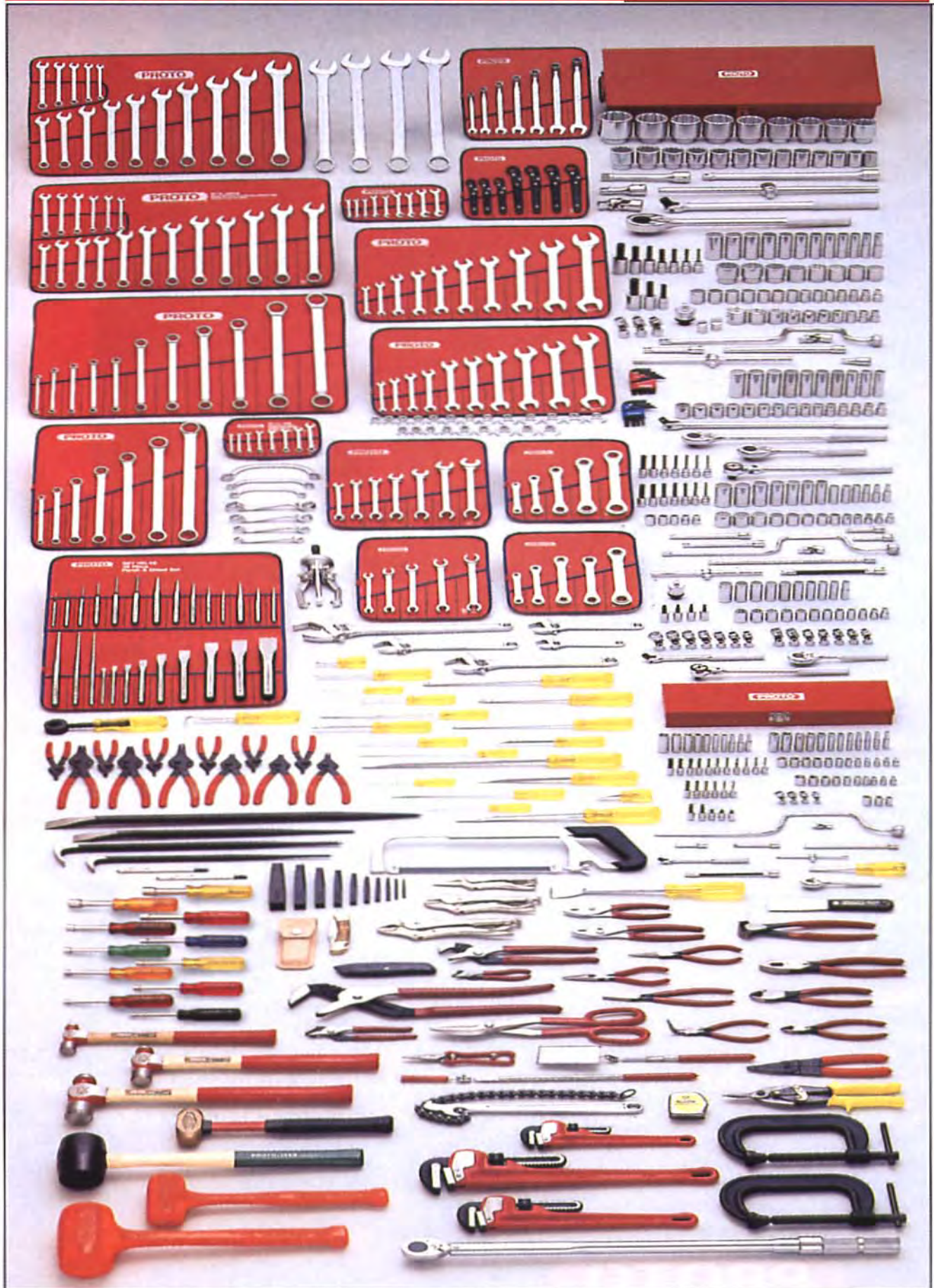

1/2" DRIVE IMPACT SOCKETS

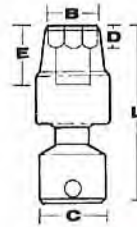
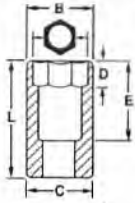

STANDARD LENGTH SOCKETS—6 POINT

No.	in.	B	C	D	E	L	lbs
†*7412H	3/8"	41/16"	15/16"	11/32"	27/32"	1 1/2"	.17
†*7414H	7/16"	23/32"	15/16"	13/32"	27/32"	1 1/2"	.17
†*7416H	1/2"	51/64"	15/16"	13/32"	27/32"	1 1/2"	.18
†*7418H	9/16"	7/8"	15/16"	7/16"	27/32"	1 1/2"	.18
†*7420H	5/8"	1"	1"	1/2"	27/32"	1 1/2"	.19
†*7422H	11/16"	1 1/32"	1 1/32"	1/2"	27/32"	1 1/2"	.20
†*7424H	3/4"	1 1/64"	1 1/64"	51/64"	27/32"	1 1/2"	.25
†*7426H	13/16"	1 13/64"	1 13/64"	11/16"	31/32"	1 5/8"	.29
†*7428H	7/8"	1 17/64"	1 9/32"	43/64"	31/32"	1 5/8"	.33
†*7430H	15/16"	1 23/64"	1 23/64"	51/64"	1 3/32"	1 3/4"	.44
†*7432H	1"	1 1/2"	1 1/2"	25/32"	1 3/32"	1 3/4"	.56
†*7434H	1 1/16"	1 23/64"	1 23/64"	25/32"	1 3/32"	1 3/4"	.59
†*7436H	1 1/8"	1 19/32"	1 19/32"	25/32"	1 1/2"	2"	.74
7438H	1 3/16"	1 19/32"	1 19/32"	3/4"	1 23/64"	2"	.76
†*7440H	1 1/4"	1 3/4"	1 3/4"	1 15/64"	1 11/32"	2"	.82
*7442H	1 5/16"	1 3/4"	1 3/4"	13/16"	63/64"	2"	.86
*7444H	1 3/8"	1 51/64"	1 5/8"	15/16"	1 3/32"	2 1/8"	.88
*7446H	1 1/16"	1 59/64"	1 5/8"	1"	1 37/64"	2 15/64"	1.01
†7448H	1 1/2"	2"	1 5/8"	1"	1 37/64"	2 15/64"	1.11

† Fed'l Specs.: GGG-W-660A
* ANSI Spec.: B107.2



DEEP LENGTH SOCKETS—6 POINT

No.	in.	B	C	D	E	L	lbs
7312H	3/8"	1 9/32"	1 5/16"	9/16"	2 5/8"	3 3/4"	.36
7314H	7/16"	2 3/32"	1 5/16"	3/8"	2 5/8"	3 3/4"	.40
7316H	1/2"	51/64"	1 5/16"	7/16"	2 5/8"	3 3/4"	.41
7318H	9/16"	7/8"	1 5/16"	1/2"	2 5/8"	3 3/4"	.41
7320H	5/8"	1"	1"	9/16"	2 5/8"	3 3/4"	.41
7322H	1 1/16"	1 1/32"	1 1/32"	5/8"	2 5/8"	3 3/4"	.42
7324H	3/4"	1 1/64"	1 1/64"	1 1/32"	2 5/8"	3 3/4"	.49
7326H	13/16"	1 3/16"	1 3/16"	1 1/32"	2 5/8"	3 3/4"	.49
7328H	7/8"	1 19/64"	1 9/32"	1 13/32"	2 7/8"	3 1/2"	.54
7330H	15/16"	1 3/8"	1 3/8"	1 13/32"	2 7/8"	3 1/2"	.70
7332H	1"	1 1/2"	1 1/2"	1 13/32"	2 7/8"	3 1/2"	.82
7334H	1 1/16"	1 1/2"	1 33/64"	1 13/32"	2 7/8"	3 1/2"	.90
7336H	1 1/8"	1 5/8"	1 5/8"	1 13/32"	2 7/8"	3 1/2"	1.15
7338H	1 3/16"	1 13/16"	1 21/32"	1 13/32"	2 7/8"	3 1/2"	1.18
7340H	1 1/4"	1 13/64"	1 21/32"	1 13/32"	2 7/8"	3 1/2"	1.27
7342H	1 5/16"	1 1/8"	1 21/32"	1 13/32"	2 7/8"	3 1/2"	1.36
7344H	1 3/8"	1 1/8"	1 13/32"	1 13/32"	2 7/8"	3 1/2"	1.38
7346H	1 1/16"	2 1/16"	1 21/32"	1 13/32"	2 7/8"	3 1/2"	1.61
7348H	1 1/2"	2 1/16"	1 21/32"	1 13/32"	2 7/8"	3 1/2"	1.80

ANSI Spec.: B107.2

UNIVERSAL SOCKETS—6 POINT

• Patented "Pinless" design for greater safety and durability.

No.	in.	B	C	D	E	L	lbs
7474P	7/16"	5/8"	1 9/64"	15/64"	21/32"	2 1/4"	.47
7475P	1/2"	47/64"	1 9/64"	1/4"	21/32"	2 21/32"	.49
7476P	9/16"	53/64"	1 9/64"	3/32"	21/32"	2 21/32"	.50
7477P	5/8"	59/64"	1 9/64"	5/16"	21/32"	2 21/32"	.50
7478P	11/16"	1 1/32"	1 9/64"	11/32"	1/2"	2 21/32"	.57
7479P	3/4"	1 1/8"	1 9/64"	3/8"	5/8"	2 7/8"	.62
7480P	13/16"	1 1/64"	1 9/64"	29/64"	11/16"	2 7/8"	.66



UNIVERSAL JOINT

• Patented "Pinless" design for greater safety and durability.

No.	L	lbs
7470P	2 5/16"	.58

Fed'l Specs.: GGG-W-660A



DEEP LENGTH SOCKETS—8 POINT

No.	in.	B	C	D	E	L	lbs
7312S	3/8"	3/4"	7/8"	11/32"	2 19/32"	3 1/4"	.41
7314S	7/16"	27/32"	1 5/16"	3/8"	2 19/32"	3 1/4"	.42
7316S	1/2"	15/16"	1 5/16"	7/16"	2 19/32"	3 1/4"	.40
7318S	9/16"	1 1/32"	1 1/2"	1/2"	2 19/32"	3 1/4"	.50
7320S	5/8"	1 1/8"	1 1/8"	1/2"	2 19/32"	3 1/4"	.58
7322S	1 1/16"	1 3/16"	1 3/16"	17/32"	2 19/32"	3 1/4"	.61
7324S	3/4"	1 5/16"	1 5/16"	9/16"	2 19/32"	3 1/4"	.78
7326S	13/16"	1 3/8"	1 3/8"	1 1/16"	2 19/32"	3 1/4"	.82
7328S	7/8"	1 1/2"	1 1/2"	1 7/16"	2 27/32"	3 1/2"	1.08
7330S	15/16"	1 39/64"	1 39/64"	3/4"	2 27/32"	3 1/2"	1.33
7332S	1"	1 11/16"	1 11/16"	13/16"	2 27/32"	3 1/2"	1.44

3/4" DRIVE IMPACT SOCKETS

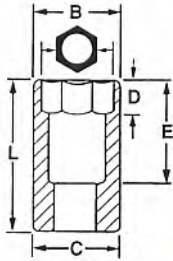

STANDARD LENGTH SOCKETS—6 POINT

No.	in.	B	C	D	E	L	lbs/ft
†*07509	9/16"	1"	1 5/8"	23/64"	1 5/16"	1 7/8"	.66
†*07510	5/8"	1 3/32"	1 5/8"	25/64"	1 5/16"	1 7/8"	.67
†*07511	1 1/16"	1 5/32"	1 5/8"	7/16"	1"	1 15/16"	.67
†*07512	3/4"	1 15/64"	1 5/8"	15/32"	1"	1 15/16"	.69
†*07513	13/16"	1 5/16"	1 5/8"	1/2"	1"	1 15/16"	.70
†*07514	7/8"	1 1/2"	1 5/8"	35/64"	1 1/16"	2"	.75
†*07515	15/16"	1 5/8"	1 5/8"	37/64"	1 1/16"	2"	.75
†*07516	1"	1 5/8"	1 5/8"	9/8"	1 1/8"	2 1/16"	.76
†*07517	1 1/16"	1 5/8"	1 5/8"	21/32"	1 1/8"	2 1/16"	.78
†*07518	1 1/8"	1 3/4"	1 3/4"	45/64"	1 1/4"	2 3/16"	.94
*07519	1 3/16"	1 7/8"	1 3/4"	47/64"	1 1/4"	2 3/16"	1.04
†*07520	1 1/4"	2"	1 3/4"	3/4"	1 1/4"	2 3/16"	1.15
†*07521	1 5/16"	2 1/8"	1 3/4"	27/32"	1 1/4"	2 3/16"	1.20
†*07522	1 3/8"	2 1/8"	1 3/4"	7/8"	1 5/16"	2 1/4"	1.23
†*07523	1 7/16"	2 1/4"	1 3/4"	7/8"	1 3/8"	2 5/16"	1.41
†*07524	1 1/2"	2 3/8"	1 3/4"	1"	1 7/16"	2 3/8"	1.56
†*07525	1 9/16"	2 3/8"	1 3/4"	1"	1 1/2"	2 7/16"	1.66
†*07526	1 5/8"	2 3/8"	1 3/4"	1"	1 1/2"	2 7/16"	1.75
07527	1 11/16"	2 39/64"	1 3/4"	1 1/8"	1 11/16"	2 5/8"	1.84
07528	1 3/4"	2 39/64"	1 3/4"	1 1/8"	1 11/16"	2 5/8"	1.93
07529	1 13/16"	2 3/4"	1 3/4"	1 1/8"	1 11/16"	2 5/8"	2.01
07530	1 7/8"	2 3/4"	1 3/4"	1 1/4"	1 7/8"	2 13/16"	2.09
07531	1 15/16"	2 3/8"	1 3/4"	1 1/4"	1 7/8"	2 13/16"	2.18
07532	2"	3"	1 3/4"	1 1/4"	1 7/8"	2 13/16"	2.22
07533	2 1/16"	3"	1 3/4"	1 3/8"	2 5/32"	3 3/32"	2.28
07534	2 1/8"	3 1/8"	1 3/4"	1 3/8"	2 5/32"	3 3/32"	2.35
07535	2 1/16"	3 1/4"	1 3/4"	1 3/8"	2 3/16"	3 1/8"	2.69
07536	2 1/4"	3 1/8"	1 3/4"	1 1/2"	2 5/16"	3 1/4"	2.73
07538	2 3/8"	3 1/2"	1 3/4"	1 1/2"	2 7/16"	3 3/8"	3.45

†Fed'l Specs.: GGG-W-660A
*ANSI Spec.: B107.1



DEEP LENGTH SOCKETS—6 POINT

No.	in.	B	C	D	E	L	lbs/ft
†*07509L	9/16"	1"	1 5/8"	15/32"	2 5/16"	3 1/4"	1.23
†*07510L	5/8"	1 3/32"	1 5/8"	33/64"	2 5/16"	3 1/4"	1.25
†*07511L	1 1/16"	1 5/32"	1 5/8"	9/16"	2 5/16"	3 1/4"	1.26
†*07512L	3/4"	1 1/4"	1 5/8"	39/64"	2 5/16"	3 1/4"	1.26
†*07513L	13/16"	1 5/16"	1 5/8"	43/64"	2 5/16"	3 1/4"	1.26
†*07514L	7/8"	1 1/2"	1 5/8"	23/32"	2 5/16"	3 1/4"	1.31
†*07515L	15/16"	1 5/8"	1 5/8"	25/32"	2 5/16"	3 1/4"	1.28
†*07516L	1"	1 5/8"	1 5/8"	53/64"	2 5/16"	3 1/4"	1.20
†*07517L	1 1/16"	1 5/8"	1 5/8"	7/8"	2 5/16"	3 1/4"	1.14
†*07518L	1 1/8"	1 3/4"	1 3/4"	59/64"	2 5/16"	3 1/4"	1.51
†07519L	1 3/16"	1 7/8"	1 3/4"	31/32"	2 5/16"	3 1/4"	1.53
†*07520L	1 1/4"	2"	1 3/4"	1"	2 5/16"	3 1/4"	1.69
†*07521L	1 5/16"	2 1/8"	1 3/4"	1"	2 5/16"	3 1/4"	1.79
†*07522L	1 3/8"	2 1/8"	1 3/4"	1"	2 5/16"	3 1/4"	1.81
†*07523L	1 7/16"	2 1/4"	1 3/4"	1 1/16"	2 7/16"	3 1/2"	2.12
†*07524L	1 1/2"	2 3/8"	1 3/4"	1 1/16"	2 7/16"	3 1/2"	2.36
†*07525L	1 9/16"	2 3/8"	1 3/4"	2"	2 7/8"	3 13/16"	2.45
†*07526L	1 5/8"	2 3/8"	1 3/4"	2 1/4"	2 7/8"	3 13/16"	2.58
07527L	1 11/16"	2 39/64"	1 3/4"	2 1/4"	2 15/16"	3 7/8"	2.66
07528L	1 3/4"	2 39/64"	1 3/4"	2 1/4"	2 15/16"	3 7/8"	2.74
07529L	1 13/16"	2 3/4"	1 3/4"	2 1/4"	2 15/16"	3 7/8"	2.87
07530L	1 7/8"	2 3/4"	1 3/4"	2 3/8"	3 1/8"	4 1/16"	3.09
07532L	2"	3"	1 3/4"	2 5/8"	2 1/8"	4 1/16"	3.18

*Fed'l Specs.: GGG-W-660E
†ANSI Spec.: B107.2

STANDARD LENGTH SOCKETS—8 POINT

No.	in.	B	C	D	E	L	lbs/ft
††*07513S	13/16"	1 5/8"	1 5/8"	23/32"	1 1/32"	2"	.76
††07514S	7/8"	1 3/4"	1 3/4"	31/32"	1 1/32"	2"	.92
††*07515S	15/16"	1 13/16"	1 3/4"	1 1/64"	1 5/32"	2 1/16"	.98
††07516S	1"	2"	1 3/4"	1 1/16"	1 5/32"	2 1/8"	1.20
††07517S	1 1/16"	2 1/8"	1 3/4"	1 1/64"	1 7/32"	2 3/16"	1.38
††07518S	1 1/8"	2 1/4"	1 3/4"	1 5/32"	1 15/64"	2 1/4"	1.41
07519S	1 3/16"	2 3/8"	1 3/4"	1 7/32"	1 11/32"	2 5/16"	1.66
††07520S	1 1/4"	2 3/8"	1 3/4"	1 17/64"	1 13/32"	2 3/8"	1.67
††07521S	1 5/16"	2 1/2"	1 3/4"	1 1/4"	1 13/32"	2 3/8"	1.81

*For Budd Wheels.

†Fed'l Specs.: GGG-W-660A
†ANSI Spec.: B107.2

Master Sets

Hand Sockets and Drive Tools

Socket Sets

Tool Boxes

Power and Impact Sockets, Accessories and Sets

Mechanic's Wrenches and Sets

Industrial Wrenches and Sets

Torque Tools

Screwdrivers and Nut Drivers

Pliers and Snips

Related Hand Tools

Pullers and Pipe Tools

C-Clamps and Work Holding Tools

Tool Holders and Cutting Tools

Eye Bolts and Shop Accessories

Hex Keys and Sets



socket sets - 1/2"

1/2" SAE UT510

13-PC. REG. SOCKET SET

SIZE	REGULAR	SIZE	REGULAR	SIZE	REGULAR
3/8"	UT5612	11/16"	UT5622	1"	UT5632
7/16"	UT5614	3/4"	UT5624	1.1/16"	UT5634
1/2"	UT5616	13/16"	UT5626	1.1/8"	UT5636
9/16"	UT5618	7/8"	UT5628		
5/8"	UT5620	15/16"	UT5630	METAL TRAY	UT5973T



1/2" METRIC UT720M

21-PC. REG. SOCKET SET

SIZE	REGULAR	SIZE	REGULAR	SIZE	REGULAR
10mm	UT5610M	17mm	UT5617M	24mm	UT5624M
11mm	UT5611M	18mm	UT5618M	25mm	UT5625M
12mm	UT5612M	19mm	UT5619M	26mm	UT5626M
13mm	UT5613M	20mm	UT5620M	27mm	UT5627M
14mm	UT5614M	21mm	UT5621M	28mm	UT5628M
15mm	UT5615M	22mm	UT5622M	30mm	UT5630M
16mm	UT5616M	23mm	UT5623M	32mm	UT5632M
				METAL BOX	UT5920B



1/2" SAE UT510D

13-PC. DEEP SOCKET SET

SIZE	DEEP	SIZE	DEEP	SIZE	DEEP
3/8"	UT5612D	11/16"	UT5622D	1"	UT5632D
7/16"	UT5614D	3/4"	UT5624D	1.1/16"	UT5634D
1/2"	UT5616D	13/16"	UT5626D	1.1/8"	UT5636D
9/16"	UT5618D	7/8"	UT5628D		
5/8"	UT5620D	15/16"	UT5630D	METAL BOX	UT5926B



1/2" SAE UT522

20-PC. REGULAR SOCKET & ATTACHMENT SET

SIZE	REGULAR	SIZE	REGULAR	SIZE	REGULAR
3/8"	UT5612	11/16"	UT5622	1"	UT5632
7/16"	UT5614	3/4"	UT5624	1.1/16"	UT5634
1/2"	UT5616	13/16"	UT5626	1.1/8"	UT5636
9/16"	UT5618	7/8"	UT5628		
5/8"	UT5620	15/16"	UT5630		

ACCESSORIES -

UT5012	RATCHET 10"	UT5070	FLEX HANDLE 15"
UT5020SP	SPARK PLUG SOCKET 5/8"	UT5080	UNIVERSAL JOINT 1/2"
UT5065	EXTENSION 5"	UT521000	MOLDED BOX
UT5066	EXTENSION 10"		



1/2" METRIC UT728M

28-PC. REGULAR SOCKET & ATTACHMENT SET

SIZE	REGULAR	SIZE	REGULAR	SIZE	REGULAR
10mm	UT5610M	17mm	UT5617M	24mm	UT5624M
11mm	UT5611M	18mm	UT5618M	25mm	UT5625M
12mm	UT5612M	19mm	UT5619M	26mm	UT5626M
13mm	UT5613M	20mm	UT5620M	27mm	UT5627M
14mm	UT5614M	21mm	UT5621M	28mm	UT5628M
15mm	UT5615M	22mm	UT5622M	30mm	UT5630M
16mm	UT5616M	23mm	UT5623M	32mm	UT5632M

ACCESSORIES -

UT5012	RATCHET 10"	UT5070	FLEX HANDLE 15"
UT5020SP	SPARK PLUG SOCKET 5/8"	UT5080	UNIVERSAL JOINT 1/2"
UT5065	EXTENSION 5"	UT729000	MOLDED BOX
UT5066	EXTENSION 10"		



GRAY TOOLS

PRO SERIES



97002



97003



97004



97007



97008



97009

Set No.	Roll Cabinet	Top Chest	Heavy Duty Base	Left Side Cabinet	Right Side Cabinet	Casters
97002	= 97290	+ 97109	+ —	+ —	+ —	+ —
97003	= 97211	+ 97120	+ —	+ —	+ —	+ —
97004	= 97250	+ 97166	+ —	+ —	+ —	+ —
97007	= 97211	+ 97120	+ 97823	+ 97418	+ —	+ —
97008	= 97290	+ 97109	+ 97823	+ 97418	+ —	+ —
97009	= 97270	+ 97120	+ 97823	+ 97418	+ —	+ —

GRAY TOOLS

HAND BOXES

19" Low Profile Box

9101	width	depth	height
Overall	19 ³ / ₄ "	6 ¹ / ₈ "	3 ¹ / ₂ "
Capacity:	328 cubic in.		
Net Weight:	3 ¹ / ₂ lbs.		
Shipping Weight:	4 lbs.		



20" Hip Roof Tool Box

9103	width	depth	height
Overall	19 ³ / ₄ "	7 ¹ / ₈ "	8 ¹ / ₈ "
Capacity:	819 cubic in.		
Net Weight:	9 lbs.		
Shipping Weight:	9 ¹ / ₂ lbs.		
97818	Tote tray included		



Tote trays have wide grip handles for extra comfort.

24" Tool Box with Side Handles

9104	width	depth	height
Overall	24 ¹ / ₄ "	9 ¹ / ₂ "	9 ¹ / ₂ "
Capacity:	1,866 cubic in.		
Net Weight:	17 lbs.		
Shipping Weight:	18 lbs.		
97820	Tote tray included		



Heavy-duty padlock eye for lockable security.

16" Utility Box

9107	width	depth	height
Overall	16"	7"	7 ¹ / ₂ "
Capacity:	840 cubic in.		
Net Weight:	7 lbs.		
Shipping Weight:	7 ¹ / ₂ lbs.		
97816	Tote tray included		



20" Heavy Duty Tool Box

9120	width	depth	height
Overall	20"	8 ¹ / ₂ "	9 ¹ / ₂ "
Capacity:	1,627 cubic in.		
Net Weight:	11 lbs.		
Shipping Weight:	12 lbs.		
97819	Tote tray included		

19" Hand Box

9109	width	depth	height
Overall	19"	7 ¹ / ₈ "	7 ¹ / ₂ "
Capacity:	1,004 cubic in.		
Net Weight:	8 lbs.		
Shipping Weight:	8 ¹ / ₂ lbs.		
97817	Tote tray included		



GRAY TOOLS



Heavy-duty latch for extra security.

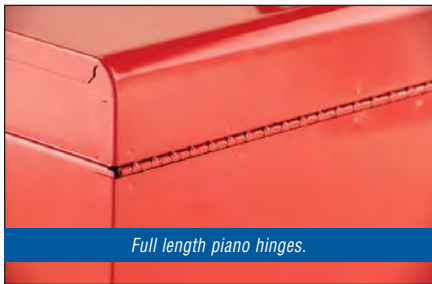

Full length piano hinges.



21" Hip Roof Tool Box

9119	width	depth	height
Overall	21"	8 1/2"	8 1/4"
Capacity:	1,319 cubic in.		
Net Weight:	12 1/2 lbs.		
Shipping Weight:	13 lbs.		
97822	Tote tray included		



2 Drawer Hand Box

97102	width	depth	height
Overall	22"	8 3/4"	10 1/2"
2 Drawers	21"	8"	2 1/4"
Capacity:	1,157 cubic in.		
Net Weight:	19 lbs.		
Shipping Weight:	20 lbs.		
97941	Lock & key included		
97914	Drawer slide		



3 Drawer Hand Box

97103	width	depth	height
Overall	22"	8 3/4"	13 1/4"
3 Drawers	21"	8"	2 1/4"
Capacity:	1,555 cubic in.		
Net Weight:	23 lbs.		
Shipping Weight:	24 1/2 lbs.		
97941	Lock & key included		
97914	Drawer slide		



18" Cantilever Tool Box

9118	width	depth	height
Overall	18"	10 1/8"	13 1/4"
Capacity:	1,530 cubic in.		
Net Weight:	21 lbs.		
Shipping Weight:	22 lbs.		



9" Slim Line Box for 1/4" Socket Set

93001	width	depth	height
Overall	9"	9 3/4"	1 3/16"
Capacity:	80 cubic in.		
Net Weight:	3 lbs.		
Shipping Weight:	3 lbs.		



12" Slim Line Box for 3/8" Socket Set

93002	width	depth	height
Overall	10 3/4"	11 5/8"	1 9/16"
Capacity:	200 cubic in.		
Net Weight:	4 1/2 lbs.		
Shipping Weight:	4 1/2 lbs.		

1/4" DRIVE SETS

GRAY TOOLS



No. 15015 15 Pieces 6 Point Standard SAE Socket Set

Contains: 3/16", 7/32", 1/4", 9/32", 5/16", 11/32", 3/8", 7/16", 1/2", 9/16"

Includes: Reversible ratchet, U-Joint, 2" Extension, 6" Extension, Hand Driver, Metal Box # 93001



No. 15025 25 Pieces 6 Point Standard & Deep SAE Socket Set

Contains: Standard 3/16", 7/32", 1/4", 9/32", 5/16", 11/32", 3/8", 7/16", 1/2", 9/16"

Deep 3/16", 7/32", 1/4", 9/32", 5/16", 11/32", 3/8", 7/16", 1/2", 9/16"

Includes: Reversible Ratchet, U-Joint, 2" Extension, 6" Extension, Hand Driver, Metal Box # 93001



No. 19017 17 Pieces 6 Point Standard Metric Socket Set

Contains: 4, 5, 6, 7, 8, 9, 10, 11, 12, 13, 14, 15mm

Includes: Reversible Ratchet, U-Joint, 2" Extension, 6" Extension, Hand Driver, Metal Box # 93001

No. 15125 25 Pieces 12 Point Standard & Deep SAE Socket Set

Contains: Standard 3/16", 7/32", 1/4", 9/32", 5/16", 11/32", 3/8", 7/16", 1/2", 9/16"

Deep 3/16", 7/32", 1/4", 9/32", 5/16", 11/32", 3/8", 7/16", 1/2", 9/16"

Includes: Reversible Ratchet, U-Joint, 2" Extension, 6" Extension, Hand Driver, Metal Box # 93001



No. 19029 29 Pieces 6 Point Standard & Deep Metric Socket Set

Contains: Standard 4, 5, 6, 7, 8, 9, 10, 11, 12, 13, 14, 15mm

Deep 4, 5, 5.5, 6, 7, 8, 9, 10, 11, 12, 13, 14mm

Includes: Reversible Ratchet, U-Joint, 2" Extension, 6" Extension, Hand Driver, Metal Box # 93001



No. 10805 5 Pieces Chrome Ratchet & Attachments

Includes: V25 Reversible Ratchet, V760 U-Joint, V602 2" Extension, V606 6" Extension, V780 Hand Driver, Metal Box # 93001

3/8" DRIVE SETS

SAE • METRIC • SOCKET SETS

GRAY TOOLS



No. 25015 15 Pieces 6 Point Standard SAE Socket Set

Contains: 3/8", 7/16", 1/2", 9/16", 5/8", 11/16", 3/4", 13/16", 7/8", 15/16", 1"

Includes: 20 Tooth Reversible Ratchet, U-Joint, 3" Extension, 6" Extension, Metal Box # 93002



No. 25115 15 Pieces 12 Point Standard SAE Socket Set

Contains: 3/8", 7/16", 1/2", 9/16", 5/8", 11/16", 3/4", 13/16", 7/8", 15/16", 1"

Includes: 20 Tooth Reversible Ratchet, U-Joint, 3" Extension, 6" Extension, Metal Box # 93002

No. 29015 15 Pieces 6 Point Standard Metric Socket Set

Contains: 9, 10, 11, 12, 13, 14, 15, 16, 17, 18, 19mm

Includes: 20 Tooth Reversible Ratchet, U-Joint, 3" Extension, 6" Extension, Metal Box # 93002

No. 29115 15 Pieces 12 Point Standard Metric Socket Set

Contains: 9, 10, 11, 12, 13, 14, 15, 16, 17, 18, 19mm

Includes: 20 Tooth Reversible Ratchet, U-Joint, 3" Extension, 6" Extension, Metal Box # 93002



No. 25215 15 Pieces 6 Point Deep SAE Socket Set

Contains: 3/8", 7/16", 1/2", 9/16", 5/8", 11/16", 3/4", 13/16", 7/8", 15/16", 1"

Includes: 20 Tooth Reversible Ratchet, U-Joint, 3" Extension, 6" Extension, Metal Box # 93002



No. 25315 15 Pieces 12 Point Deep SAE Socket Set

Contains: 3/8", 7/16", 1/2", 9/16", 5/8", 11/16", 3/4", 13/16", 7/8", 15/16", 1"

Includes: 20 Tooth Reversible Ratchet, U-Joint, 3" Extension, 6" Extension, Metal Box # 93002

No. 29215 15 Pieces 6 Point Deep Metric Socket Set

Contains: 9, 10, 11, 12, 13, 14, 15, 16, 17, 18, 19mm

Includes: 20 Tooth Reversible Ratchet, U-Joint, 3" Extension, 6" Extension, Metal Box # 93002

No. 29315 15 Pieces 12 Point Deep Metric Socket Set

Contains: 9, 10, 11, 12, 13, 14, 15, 16, 17, 18, 19mm

Includes: 20 Tooth Reversible Ratchet, U-Joint, 3" Extension, 6" Extension, Metal Box # 93002



No. 38020 20 Pieces 6 Point Standard SAE Socket Set

Contains: 3/8", 7/16", 1/2", 9/16", 5/8", 11/16", 3/4", 13/16", 7/8", 15/16", 1", 1 1/16", 1 1/8", 1 3/16", 1 1/4"
on socket rail # SB191615

Includes: Reversible Ratchet, Flex Handle, Universal Joint, 5" Extension, 10" Extension, Metal Box # 9101



No. 38117 17 Pieces 12 Point Standard SAE Socket Set

Contains: 7/16", 1/2", 9/16", 5/8", 11/16", 3/4", 13/16", 7/8", 15/16", 1", 1 1/16", 1 1/8"
on socket rail # SB151611

Includes: Reversible Ratchet, Flex Handle, Universal Joint, 5" Extension, 10" Extension, Metal Box # 9101



No. 38217 17 Pieces 6 Point Deep SAE Socket Set

Contains: 7/16", 1/2", 9/16", 5/8", 11/16", 3/4", 13/16", 7/8", 15/16", 1", 1 1/16", 1 1/8"
on socket rail # SB151611

Includes: Reversible Ratchet, Flex Handle, Universal Joint, 5" Extension, 10" Extension, Metal Box # 9101



No. 38120 20 Pieces 12 Point Standard SAE Socket Set

Contains: 3/8", 7/16", 1/2", 9/16", 5/8", 11/16", 3/4", 13/16", 7/8", 15/16", 1", 1 1/16", 1 1/8", 1 3/16", 1 1/4"
on socket rail # SB191615

Includes: Reversible Ratchet, Flex Handle, Universal Joint, 5" Extension, 10" Extension, Metal Box # 9101



No. 35012 12 Pieces 6 Point Standard SAE Socket Set

Contains: 7/16", 1/2", 9/16", 5/8", 11/16", 3/4", 13/16", 7/8", 15/16", 1", 1 1/16", 1 1/8"

Includes socket rail # SB191615

No. 35015 15 Pieces 6 Point Standard SAE Socket Set

Contains: 3/8", 7/16", 1/2", 9/16", 5/8", 11/16", 3/4", 13/16", 7/8", 15/16", 1", 1 1/16", 1 1/8", 1 3/16", 1 1/4"

Includes socket rail # SB191615

No. 35020 19 Pieces 6 Point Standard SAE Socket Set

Contains: 3/8", 7/16", 1/2", 9/16", 5/8", 11/16", 3/4", 13/16", 7/8", 15/16", 1", 1 1/16", 1 1/8", 1 3/16", 1 1/4", 1 5/16", 1 3/8", 1 7/16", 1 1/2"

Includes 2 socket rails # SB151611



No. 35112 12 Pieces 12 Point Standard SAE Socket Set

Contains: 7/16", 1/2", 9/16", 5/8", 11/16", 3/4", 13/16", 7/8", 15/16", 1", 1 1/16", 1 1/8"

Includes socket rail # SB191615

No. 35115 15 Pieces 12 Point Standard SAE Socket Set

Contains: 3/8", 7/16", 1/2", 9/16", 5/8", 11/16", 3/4", 13/16", 7/8", 15/16", 1", 1 1/16", 1 1/8", 1 3/16", 1 1/4"

Includes socket rail # SB191615

No. 35120 19 Pieces 12 Point Standard SAE Socket Set

Contains: 3/8", 7/16", 1/2", 9/16", 5/8", 11/16", 3/4", 13/16", 7/8", 15/16", 1", 1 1/16", 1 1/8", 1 3/16", 1 1/4", 1 5/16", 1 3/8", 1 7/16", 1 1/2"

Includes 2 socket rails # SB151611



No. 35212 12 Pieces 6 Point Deep SAE Socket Set

Contains: 7/16", 1/2", 9/16", 5/8", 11/16", 3/4", 13/16", 7/8", 15/16", 1", 1 1/16", 1 1/8"

Includes socket rail # SB191615

No. 35215 15 Pieces 6 Point Deep SAE Socket Set

Contains: 3/8", 7/16", 1/2", 9/16", 5/8", 11/16", 3/4", 13/16", 7/8", 15/16", 1", 1 1/16", 1 1/8", 1 3/16", 1 1/4"

Includes socket rail # SB191615



No. 35312 12 Pieces 12 Point Deep SAE Socket Set

Contains: 7/16", 1/2", 9/16", 5/8", 11/16", 3/4", 13/16", 7/8", 15/16", 1", 1 1/16", 1 1/8"

Includes socket rail # SB191615

No. 35315 15 Pieces 12 Point Deep SAE Socket Set

Contains: 3/8", 7/16", 1/2", 9/16", 5/8", 11/16", 3/4", 13/16", 7/8", 15/16", 1", 1 1/16", 1 1/8", 1 3/16", 1 1/4"

Includes socket rail # SB191615

3/4" DRIVE SETS

GRAY TOOLS



No. MHD15 15 Pieces 12 Point Metric Socket Set

Contains: 24, 25, 26, 27, 28, 29, 30, 32, 35, 36mm

Includes: Reversible Ratchet Head, Handle, Drive Head, 8" Extension, Tool Box # 9101



No. HD12 12 Pieces 12 Point SAE Socket Set

Contains: 1", 1 1/16", 1 1/8", 1 1/4", 1 3/8", 1 7/16", 1 1/2", 1 5/8"

Includes: Handle, Drive Head, 8" Extension, Metal Box # 9101



No. 45110 10 Pieces 12 Point SAE Socket Set

Contains: 1 5/16", 1", 1 1/16", 1 1/8", 1 1/4", 1 5/16", 1 3/8", 1 7/16", 1 1/2", 1 5/8"

Includes 2 socket rails # SB191615

No. HD15 15 Pieces 12 Point SAE Socket Set

Contains: 7/8", 1", 1 1/16", 1 1/8", 1 1/4", 1 3/8", 1 7/16", 1 1/2", 1 5/8", 1 3/4"

Includes: Reversible Ratchet Head, Handle, Drive Head, 8" Extension, Metal Box # 9101

No. HD21 22 Pieces 12 Point SAE Socket Set

Contains: 7/8", 1 5/16", 1", 1 1/16", 1 1/8", 1 3/16", 1 1/4", 1 5/16", 1 3/8", 1 7/16", 1 1/2", 1 5/8", 1 3/4", 1 13/16", 1 7/8", 2"

Includes: Reversible Ratchet Head, Handle, Drive Head, 15 1/2" Extension, 8" Extension, Metal Box # 9119

No. HD25 26 Pieces 12 Point SAE Socket Set

Contains: 7/8", 1 5/16", 1", 1 1/16", 1 1/8", 1 3/16", 1 1/4", 1 5/16", 1 3/8", 1 7/16", 1 1/2", 1 5/8", 1 11/16", 1 3/4", 1 13/16", 1 7/8", 2", 2 3/16"

Includes: Reversible Ratchet Head, Handle, Flex Handle, Drive Head, 15 1/2" Extension, 8" Extension, 4" Extension, Metal Box # 9119

1" DRIVE SET



No. XH25 24 Pieces 12 Point Standard SAE Socket Set

Contains: 1 7/16", 1 1/2", 1 5/8", 1 11/16", 1 13/16", 1 7/8", 2", 2 3/16", 2 1/4", 2 5/16", 2 3/8", 2 7/16", 2 1/2", 2 9/16", 2 5/8", 2 3/4", 3"

Includes: 8" Extension, 17" Extension, Sliding "T" Handle, Reversible Ratchet, Flex Handle, Adapter 3/4" female 1" male, Metal Box # 9104

1" DRIVE SET



No. XH16 15 Pieces 12 Point Standard SAE Socket Set

Contains: 1 7/16", 1 1/2", 1 5/8", 1 11/16", 1 13/16", 1 7/8", 2", 2 3/16", 2 1/4", 2 3/8", 2 1/2"

Includes: 8" Extension, Sliding "T" Handle, Reversible Ratchet, Metal Box # 9104

WRENCH SETS

SAE • MIRROR CHROME COMBINATION

GRAY TOOLS



**No. TU4 4 Pieces 12 Point
SAE Mirror Chrome Wrench Set**

Contains: 1/4", 5/16", 11/32", 3/8"
Carded



**No. TU7 7 Pieces 12 Point
SAE Mirror Chrome Wrench Set**

Contains: 7/16", 1/2", 9/16", 5/8", 11/16", 3/4", 7/8"
Includes organizer # 94711



**No. TU9 9 Pieces 12 Point
SAE Mirror Chrome Wrench Set**

Contains: 3/8", 7/16", 1/2", 9/16", 5/8", 11/16", 3/4", 7/8", 1"
Includes organizer # 94711



**No. TU11 11 Pieces 12 Point
SAE Mirror Chrome Wrench Set**

Contains: 3/8", 7/16", 1/2", 9/16", 5/8", 11/16", 3/4", 13/16", 7/8",
15/16", 1"
Includes organizer # 94711



**No. TU14S 14 Pieces 12 Point
SAE Mirror Chrome Wrench Set**

Contains: 3/8", 7/16", 1/2", 9/16", 5/8", 11/16", 3/4", 13/16", 7/8",
15/16", 1", 1 1/16", 1 1/8", 1 1/4"
Includes organizer # 94715



**No. TU19 19 Pieces 12 Point
SAE Mirror Chrome & Satin Finish Set**

Contains: 3/8", 7/16", 1/2", 9/16", 5/8", 11/16", 3/4", 13/16", 7/8",
15/16", 1", 1 1/16", 1 1/8", 1 1/4", 1 5/16", 1 3/8", 1 7/16", 1 1/2", 1 5/8"
Includes roll # 2015

OFFSET STRIKING FACE WRENCHES

GRAY TOOLS

SAE

Offset Striking Face Box Wrench 45° Offset Head

Hex Size	12 Point Part No.	Overall Length, in. a	Head Depth, in. b	Head Diameter, in. c	Weight lbs.
1"	66832	11	7/8	2	2.8
1 1/16"	66834	11	7/8	2	2.8
1 1/8"	66836	11	7/8	2	2.8
1 3/16"	66838	11	7/8	2 1/16	2.8
1 1/4"	66840	11	7/8	2 1/16	2.8
1 5/16"	66842	11	7/8	2 1/16	2.8
1 3/8"	66844	11	7/8	2 1/16	2.6
1 7/16"	66846	12 1/2	1 1/8	2 3/4	6.4
1 1/2"	66848	12 1/2	1 1/8	2 3/4	6.4
1 9/16"	66850	12 1/2	1 1/8	2 3/4	6.2
1 5/8"	66852	12 1/2	1 1/8	2 3/4	6.2
1 11/16"	66854	12 1/2	1 1/8	2 13/16	6.2
1 3/4"	66856	12 1/2	1 1/8	2 13/16	6.2
1 13/16"	66858	12 1/2	1 1/8	2 31/32	6.2
1 7/8"	66860	12 1/2	1 1/8	2 31/32	6.2
1 15/16"	66862	12 1/2	1 1/8	2 31/32	6.2
2"	66864	12 3/4	1 1/8	3 1/8	6.2
2 1/16"	66866	12 3/4	1 1/8	3 1/8	6.0
2 1/8"	66868	14	1 3/8	3 5/8	9.2
2 3/16"	66870	14	1 3/8	3 3/4	9.2
2 1/4"	66872	14	1 3/8	3 3/4	9.2
2 5/16"	66874	14	1 3/8	3 3/4	9.2
2 3/8"	66876	14	1 3/8	3 3/4	9.0
2 7/16"	66878	14	1 3/8	3 31/32	9.2
2 1/2"	66880	14 1/2	1 5/16	4	9.2
2 9/16"	66882	14 1/2	1 5/16	4 1/8	9.2
2 5/8"	66884	14 1/2	1 5/16	4 1/8	9.0
2 11/16"	66886	16	1 3/4	4 7/8	16.2
2 3/4"	66888	16	1 3/4	4 7/8	15.4
2 13/16"	66890	16	1 3/4	4 7/8	16.0
2 7/8"	66892	16	1 3/4	4 7/8	15.8
2 15/16"	66894	16	1 3/4	4 7/8	15.4
3"	66896	16	1 3/4	4 7/8	15.2
3 1/16"	66898	16	1 3/4	4 7/8	15.0
3 1/8"	66899	16	1 3/4	4 13/16	15.0

Specs: CGSB 39-GP-11C Type 5. U.S. GGG-W-636E. ANSI B107.6 - 1994.



FEATURES

- ▶ Each wrench coated with black oxide and waxed for a rust-resistant finish
- ▶ No other tool company offers the complete range 1" - 3 1/8"
 - ▶ 35 hex sizes
 - ▶ no missing sizes
- ▶ Forged from high carbon alloy steel for extra heavy duty strength

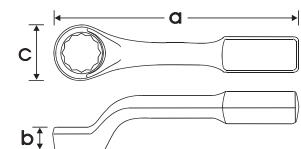



1/4" Micro-adjustable, Click-Type

Square Drive	Part No.	Capacity in. lb. (Nm)	Increments in. lb. (Nm)	Head Style	Length in.
1/4"	71200	30-200 (3.96-23.16)	1 (0.11)	Fixed Ratchet	10 1/4"

Torques both directions with quick release
Includes Custom Molded Plastic Case



3/8" Micro-adjustable, Click-Type

Square Drive	Part No.	Capacity in. lb. (Nm)	Increments in. lb. (Nm)	Head Style	Length in.
3/8"	72250	50-250 (6.22-28.85)	1 (0.11)	Fixed Ratchet	10"
3/8"	*72075	5-75 (10.1-105.1)	0.5 (0.7)	Flex Ratchet	17 5/8"
3/8"	*72100	10-100 (16.9-138.9)	0.5 (0.7)	Fixed Ratchet	17 3/4"

Torques both directions * with quick release
Includes Custom Molded Plastic Case



1/2" Micro-adjustable, Click-Type

Square Drive	Part No.	Capacity ft. lb. (Nm)	Increments ft. lb. (Nm)	Head Style	Length in.
1/2"	73250	25-250 (43.4-348.4)	1 (1.4)	Fixed Ratchet	21 1/4"
1/2"	73251	25-250 (43.4-348.4)	1 (1.4)	Flex Ratchet	22 1/2"

Torques both directions with quick release
Includes Custom Molded Plastic Case



3/4" Micro-adjustable, Click-Type

Square Drive	Part No.	Capacity ft. lb. (Nm)	Increments ft. lb. (Nm)	Head Style	Length in.
3/4"	*74600	100-600 (153-830)	2.5 (3.4)	Round Head Fixed	41 1/4"
3/4"	*MFR600HD	100-600 (153-830)	5 (7)	Tear Drop Head Fixed	43"
1"	MF2000	300-2,000 (474-2700)	10 (13.5)	Plain Head	109"

Torques both directions
* Includes Storage Case



Dial Type with Memory Needle - Inch Pound

Square Drive	Part No.	Capacity in. lb. (Nm)	Increments in. lb. (Nm)	Length in.
1/4"	DIN75A	0-75 (0-9)	0.5 (0.25)	10
3/8"	DIN250A	0-250 (0-30)	5 (0.5)	12 1/4
3/8"	DIN600A	0-600 (0-70)	10 (2)	12 1/4

Includes Custom Molded Plastic Case



Dial Type With Memory Needle - Foot Pound

Square Drive	Part No.	Capacity ft. lb. (Nm)	Increments ft. lb. (Nm)	Length in.
3/8"	DFN50A	0-50 (0-70)	1 (2)	12
1/2"	DFN250A	0-250 (0-350)	5 (10)	20 1/2
1/2"	* DF250R	0-250 (0-350)	5 (10)	23
1"	** DFE1000	0-1000 (0-1,400)	20 (25)	74

* With Ratchet Head ** Electric Light and Audible Buzzer in Metal Box

Includes Custom Molded Plastic Case

Torque Screwdriver - Dual Range Adjustable Micrometer

Square Drive	Part No.	Capacity in. lb. (Nm)	Increments in. lbs. (Nm)	Length in.
1/4"	SM35	4-36 (.45-4.07)	.4 (.04)	6 7/8

Square Drive	Part No.	Capacity in. oz. (Nm)	Increments in. oz. (Nm)	Length in.
1/4"	SM100	20-100 (.14-.71)	2 (.01)	6 7/8

0025 Adapter converts the torque screwdrivers from 1/4" male square to 1/4" female hex.



Precision Torque Multiplier - 10 to 1 Ratio

Part No.	Input Drive	Output Drive	Max Input Torque ft. lb. (Nm)	Max Output Torque ft. lb. (Nm)	Gear Ratio	Total Length Body & Reaction Bar	Weight lbs.
TM750	3/8" F	3/4" M	75 ft. lb. (10 MKP)	750 ft. lb. (100 MKP)	10-1	18"	12
TM2000	1/2" F	1" M	200 ft. lb. (28 MKP)	2,000 ft. lb. (280 MKP)	10-1	32 1/2"	18

Federal Spec. GGG-W-00686C. ANSI Spec. B107.14M.

SLIP • SOLID • GROOVE JOINT

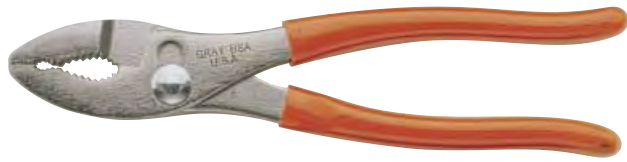

Slip Joint with Vinyl Grips

Part No.	Overall Length, in.	Jaw Length, in.	Capacity, in.
B6A	6 ³ / ₄	1 ³ / ₈	1
B8A	8	1 ⁵ / ₈	1 ¹ / ₄
B10A	9 ⁷ / ₈	1 ⁵ / ₈	1 ¹ / ₂

Thin Nose Slip Joint with Vinyl Grips

B56A	6 ³ / ₄	1 ³ / ₈ Straight	1
-------------	-------------------------------	--	---



Adjustable Joint with Vinyl Grips

Part No.	Overall Length, in.	Jaw Length, in.	Capacity, in.
B45-7A	7 ³ / ₈	1	³ / ₄
B45-10A	10 ¹ / ₈	1 ³ / ₈	1 ¹ / ₂
B45-12A	12 ³ / ₄	1 ³ / ₄	2 ⁵ / ₈
B45-16A	16	2	4 ¹ / ₄
B45-20	20	3	5 ¹ / ₂



Water Pump with Vinyl Grips

Part No.	Overall Length, in.	Jaw Length, in.	Capacity, in.
258A	10 ¹ / ₄	1 ¹ / ₂	2 ¹ / ₈



Ignition Slip Joint with Vinyl Grips

Part No.	Overall Length, in.	Jaw Length, in.	Capacity, in.
518A	5 ¹ / ₄	¹ / ₂	³ / ₄



Lineman's Combination with Cutter and Vinyl Grips

Part No.	Overall Length, in.	Jaw Length, in.
B210A	6 ¹ / ₂	1
B212A	7 ¹ / ₄	1 ³ / ₁₆
B214A	8 ¹ / ₂	1 ⁵ / ₁₆
B218A	9 ¹ / ₂	1 ¹ / ₂



Flat Nose/Duck Bill with Vinyl Grips

Part No.	Overall Length, in.	Description	Jaw Length, in.
B295A	8	Duck Bill	1 ⁵ / ₁₆
B224A	6 ¹ / ₂	Flat Nose	2



End Cutting with Plain Handle

Part No.	Overall Length, in.	Jaw Length, in.
B253	11	1 ³ / ₁₆



End Cutting with Vinyl Grips

Part No.	Overall Length, in.	Jaw Length, in.
B255	6	⁷ / ₁₆
B258A	7 ¹ / ₄	⁵ / ₁₆

WISE-GRIP PLIERS

Long Nose with Wire Cutter

Part No.	Length	Jaw Opening		Jaw Thickness		Jaws
	in.	Tips, in.	Base, in.	Tips, in.	Base, in.	Length, in.
4LN	4 ³ / ₄	1 ³ / ₄	³ / ₄	¹ / ₈	¹ / ₄	1 ¹ / ₂
6LN	6	2 ¹ / ₄	1	¹ / ₈	⁵ / ₁₆	1 ³ / ₄
9LN	9	3	1 ³ / ₄	³ / ₁₆	¹³ / ₃₂	2 ¹ / ₂

Straight Jaw

Part No.	Length in.	Jaw Opening in.	Jaw Thickness in.
7R	7	1 ¹ / ₈	⁷ / ₁₆
10R	10	1 ¹ / ₂	⁵ / ₈

Curved Jaw

Part No.	Length in.	Jaw Opening in.	Jaw Thickness in.
7CR	7	1 ⁵ / ₈	⁵ / ₁₆
10CR	10	1 ⁷ / ₈	³ / ₈

Curved Jaw with Wire Cutter

Part No.	Length in.	Jaw Opening in.	Jaw Thickness in.
4WR	4	¹⁵ / ₁₆	¹ / ₄
5WR	5	1 ¹ / ₄	¹ / ₄
7WR	7	1 ⁵ / ₈	⁵ / ₁₆
10WR	10	1 ⁷ / ₈	³ / ₈

Sheet Metal Clamp

Part No.	Length in.	Jaw Width in.	Throat Depth in.
8R	8	³ / ₈	1 ³ / ₄

Locking Wrench With Wire Cutter

Part No.	Length in.	Jaw Width in.	Jaw Width mm
4LW	4	¹ / ₄ to ⁹ / ₁₆	7 to 14
7LW	7	⁷ / ₁₆ to ³ / ₄	11 to 19
10LW	10	⁵ / ₈ to 1 ¹ / ₈	16 to 28

Welding Clamp

Part No.	Length in.	Jaw Width in.	Throat Depth in.
9R	9	1 ⁵ / ₈	2 ³ / ₄

Locking Chain Clamp

Part No.	Description	Wrench Length, in.	Chain Length, in.
20R	Chain Clamp	8 ³ / ₄	19
20R-CHN	Replacement Chain	—	18

Locking Grip "C" Clamp

Part No.	Length in.	Opening in.	Depth in.	Height in.
11R	11	3 ³ / ₄	2 ⁵ / ₈	3 ³ / ₄

Locking Grip "C" Clamp with Swivel Pads

Part No.	Length in.	Opening in.	Depth in.	Height in.
6SP	6 ¹ / ₂	2	1 ¹ / ₂	2
11SP	11 ¹ / ₄	3 ³ / ₄	2 ⁵ / ₈	3 ³ / ₄
18SP	18 ¹ / ₄	7	10	4



Note: Vise-Grip® is a registered trademark of American Tool.

SNIPS

GRAY TOOLS

No. 1013S 3 Piece Set
Aviation Snips - Colour Code Vinyl Grips
 Set consists of: 101S, 101L, 101R
 Carded

Aviation Snips - Colour Code Vinyl Grips

Part No.	Cut, in.	Cuts	Grip Colour	Length, in.
101S	1½	Straight	Yellow	10
101L	1½	Left	Red	10
101R	1½	Right	Green	10

Long Nose Aviation Snip w/Vinyl Grips

Part No.	Cut, in.	Cutting Capacity	Length, in.
84201	3	20 ga. Cold Rolled Steel 24 ga. Stainless Steel	11½

Offset Aviation Snips - Colour Code Vinyl Grips

Part No.	Cut, in.	Cuts	Grip Colour	Length, in.
110	1½	Right & Straight	Green	10
111	1½	Left & Straight	Red	10

Aviation - Notching Shear with Vinyl Hand-guard Grips

Part No.	Cut, in.	Cuts	Grip Colour	Length, in.
102	7/8	Straight	Red	9½

Lightweight Magnesium

Part No.	Cut, in.	Cutting Capacity	Length in.	Replacement Blade Kit
81200	3½	22 ga. Cold Rolled 26 ga. Stainless Steel	12	81201

Straight Pattern with Vinyl Grips

Part No.	Cut, in.	Length, in.
S47A	1½	7
S410A	2½	10
S412A	3	12½

Combination Circle Pattern-Duckbill with Vinyl Grips

Part No.	Cut, in.	Length, in.
77DA	1¾	7
107DA	2¼	10
127DA	3	12½

Straight Pattern - Bulldog with Vinyl Grips

Part No.	Cut, in.	Length, in.
S416A	2½	16½

Light Metal Wire-cutting Shears

Part No.	Cut, in.	Length, in.
B49	1¼	6½



991-57: 57 Piece 1000 volt Tool Kit, 1/2" drive

HIP

11 Piece Insulated Socket Set with Reversible Ratchet, 3/8" Drive



1000 V
EN 60900



Consisting of 57 Insulated Tools in 4 sections:
Screwdrivers: 8 slot, 3 Phillips, 3 Robertson®
7 Open-end Wrenches: 3/8" to 3/4"
8 Nutdrivers, 5" blade: 3/16" to 9/16"
1 x waterpump plier, 10"
1 x combination plier, 8"
1 x cable cutter, 6-1/4"
1 x cable cutter, 8-1/4"
1 x long nose plier w. cutter, 8"
1 x side cutter, 7"
1 x high leverage side cutter/piano wire, 18", 8"

Torque Wrench, 1/2" drive, locking
Reversible Ratchet, lockable
14 sockets 3/8" to 1-1/4", 12 point
1 x extension 5", lockable
1 x extension 10", lockable
1 x T-handle, lockable
2 knives

895-17: Telecom Tool Box



- 3/8" drive kit contains :
• Screwdriver: 4 slot, 1 Phillips®
• 1 x combination plier, 8"
• 1 x long nose plier w. cutter 6-1/4"
• 1 x flat nose plier, 6-1/4"
• 1 x reversible 3/8" drive ratchet (280-190)
• 1 x reversible 3/8" drive torque wrench, 8"(282525-38)
• 4 sockets: 3/8", 7/16", 1/2", 9/16", 12 point
• 1 socket: 5/8" DEEP WALL 12 point
• 1 x extension 5"(285125-3/8)
• Tool box with lift out tray



890-41: Basic Inside Maintenance Kit

- 3/8" drive kit contains :
• Screwdriver: 3 slot, 2 Phillips, 2 Robertson®
• 8 box wrenches: 3/8" to 13/16"
• 8 Nutdrivers, 5" long: 3/16" to 9/16"
• 1 x waterpump plier, 10"
• 4 Hex keys: 3/16", 1/4", 5/16", 3/8"
• 1 x reversible 3/8" drive ratchet (280-190)

- 1 x reversible 3/8" dr. torque wrench, 8"(282525-38)
- 8 sockets 3/8" to 13/16" DEEP WALL, 12 point
- 1 x extension 5"(285125-3/8)
- 1 x extension 10"(285250-3/8)
- 1 x T-handle, 8" (290200-3/8)
- Tool box with lift out tray



310

MADE IN GERMANY



253810K

Contains:

1 ratchet 3/8" (# 310499)
1 extension 5"
1 extension 10"
1 T-handle

1 of each socket*:
5/16" + 8 mm
3/8" + 10 mm
7/16" + 11 mm
1/2" + 13 mm
9/16" + 14 mm
5/8" + 16 mm
3/4" + 19 mm



253810KM-12

Contains:

1 ratchet 3/8" (# 310499)
1 extension 5"
1 extension 10"
1 T-handle

1 of each socket: 10 mm
11 mm
12 mm
13 mm
14 mm
17 mm
19 mm

* The same socket is designed for both imperial and equivalent metric sizes (flank drive socket)

980-15: Insulated Socket Set, 1/4" Drive

Contains:

- Reversible ratchet (280-140), 1/4" drive
- 10 sockets 3/16", 7/32", 1/4", 9/32", 5/16", 11/32", 3/8", 7/16", 1/2", 9/16", 6 point
- 4 extensions: 2", 3", 4", 6"
- Heavy Duty Nanuk Case (same characteristics as the Heavy Duty 990/991 cases)



970-17: Insulated Socket Set, 1/4" Drive

Contains:

- Reversible ratchet (280-140), 1/4" drive
- 10 sockets 3/16", 7/32", 1/4", 9/32", 5/16", 11/32", 3/8", 7/16", 1/2", 9/16", 6 point
- 4 extensions: 2", 3", 4", 6"
- T-handle, 6-1/4"
- Magnetic 1/4" bit-holder adaptor with retaining ring



3/8" drive kit contains :
Screwdriver: 3 slot, 2 Phillips, 2 Robertson®
11 box wrenches: 1/4" to 7/8"
8 Nutdrivers, 5" long: 3/16" to 9/16"
1 x waterpump plier, 10"
1 x combination plier, 8"
1 x long nose plier w. cutter 8"
1 x H.D. side cutter 8" (137149VDE-200)

5 Hex keys: 3/16", 1/4", 5/16", 3/8", 1/2"
1 x reversible 3/8" drive ratchet (280-190)
1 x reversible 3/8" drive torque wrench, 8"(282525-38)
11 sockets 1/4" to 7/8" DEEP WALL, 12 point
1 x extension 5"(285125-3/8)
1 x extension 10"(285250-3/8)
1 x T-handle, 8" (290200-3/8)

892-51: Inside Maintenance Kit (with locking Torque wrench)



3/8" drive kit contains :
Screwdriver: 3 slot, 2 Phillips, 2 Robertson®
11 box wrenches: 1/4" to 7/8"
8 Nutdrivers, 5" long: 3/16" to 9/16"
1 x waterpump plier, 10"
on plier, 8"
1 x long nose plier w. cutter 8"
1 x H.D. side cutter 8" (137149VDE-200)

5 Hex keys: 3/16", 1/4", 5/16", 3/8", 1/2"
1 x reversible 3/8" drive ratchet (280-190)
1 x reversible 3/8" drive torque wrench, 11"(307-227in)
11 sockets 1/4" to 7/8" DEEP WALL, 12 point
1 x extension 5"(285125-3/8)
1 x extension 10"(285250-3/8)
1 x T-handle, 8" (290200-3/8)

890-11P: 11 Piece Insulated tool roll



Tool roll consists of:

Screwdriver(7):
Slot: 018-30-100(1/8x.0197)
018-40-100(5/32x.0313)
018-55-125(7/32x.0394)

Philips®: 019-PH1
019-PH2

Robertson®: 020-ROB1
020-ROB2

1 x waterpump plier, 10"(161491000V-250)
1 x combination plier, 8"(1149VDE-205)
1 x long nose pliers w. cutter 8"(14049VDE-205)
1 x side cutter 7"(13449VDE-180)

890-10P: 10 Piece Insulated tool roll



Tool roll consists of:

Screwdriver(6):
Slot: 01830-100(1/8x0.197)
01855-125(7/32x.0394)

Philips®: 019-PH1
019-PH2

Robertson®: 020-ROB1
020-ROB2

1 x combination plier, 8"(1149VDE-205)
1 x long nose plier w. cutter 8"(14049VDE-205)
1 x side cutter 7"(13449VDE-180)
1 x cable knife(2040)

1000 volt pliers with Insulated head * special order *

- The handles are double insulated red exterior, yellow interior
- The heads are insulated with a material permitting a maximum opening of 30°



Code	Description
132-205	Combination pliers, 8"
136-200	Long nose pliers w. cutter, 8"
138-200	Long nose pliers w. cutter, 45°, 8"
148-180	Side cutter, 7"

HIP



nws



13549VDE-190: 3-function Insulated side cutters with crimp, dedicated wire stripper (AWG 15+13), 1000 volts, 7-1/2"



137149VDE-200: Insulated High-leverage side cutters, suitable for piano wire, **18° angled cutting surface 62 HRC**, 1000 volts, 8"
137149VDE-240: Insulated High-leverage side cutters suitable for piano wire, **18° angled cutting surface 62HRC**, 1000 volts, 9-1/2"



14049VDE-170: Insulated long nose pliers w. cutter 1000 volts, 6-3/4"



14049VDE-205: Insulated long nose pliers w. cutter, 1000 volts, 8"



14149VDE-170: Insulated long nose pliers with cutter, 45°, 1000 volts, 6-3/4"

14149VDE-205: Insulated long nose pliers with cutter, 45°, 1000 volts, 8"



14549VDE-160: Easily adjustable wire stripper with knurled screw and lock nut, spring, V-groove, capacity AWG 7, 6-1/4"

16149-1000V-250: Insulated box-joint waterpump pliers, isolées 1000 volts, 10"



nws



NWS Series 49VDE pliers represents a new generation of 1000 V insulated pliers. The new ergonomic handle design reduces fatigue. The new 2-component Soft-Gripp handle also make the pliers highly visible with its yellow and red combination, so that the worker cannot accidentally mistake them for normal pliers. The handles are made from fully organic raw materials, making the handles slip-resistant.



04349VDE-160: Insulated cable cutter 1000 volts, cap. 5/8" diam., 6-1/4"



04349VDE-210: Insulated cable cutter 1000 volts, cap. 1" diam., 8-1/4"



11149VDE-165: Insulated combination pliers, 1000 volts, 6-1/4"



11149VDE-180: Insulated combination pliers, 1000 volts, 7"



11149VDE-205: Insulated combination pliers, 1000 volts, 8"



12449VDE-160: Insulated flat nose pliers, 1000 volts, 6-1/4"



12549VDE-160: Insulated round nose pliers 1000 volts, 6-1/4"

13449VDE-145: Insulated side cutters, 1000 volts, 5-3/4"

13449VDE-160: Insulated side cutters, 1000 volts, 6-1/4"

13449VDE-180: Insulated side cutters, 1000 volts, 7"



Code	Size
762-200	8"
762-250	10"
762-300	12"



Code	Size / Blade
765-250	10" / 6"
771-150	Replacement Blade

745-35: Dead-blow Hammer



Code	Description	Size
745-35	Dead-blow hammer	1-3/8", 28 oz
745EK-35	Replacement tip/unit	1-3/8"

767: Hacksaw



Code	Size / Blade
767-460	18" / 12"
771-300	Replacement Blade

046: Ratcheting Cable Cutter



Code	Size	Capacity
0461000V-250	10"	CU 1-1/4"
046E-250	Replacement Blade	

128: Ratcheting Cable Cutter, insulated head, front cut



Code	Size	Capacity
128-290	11-1/2"	CU 1-1/16"



Each tool double insulated red exterior, yellow interior

MADE IN GERMANY



Adjustable Wrenches

Overall Length, in.	Part No. Chrome	Part No. Black Oxide	Maximum Opening, in.
4	65104	65204	1/2
6	65106	65206	3/4
8	65108	65208	15/16
10	65110	65210	1 1/8
12	65112	65212	1 5/16
15	65115	65215	1 11/16
18	65118	65218	2 1/16
24	65124	65224	2 7/16

Federal Spec. CDA 39-GP-13A U.S. GGG-W-631B.

BW812S 2 Piece Adjustable Wrench Set

Part No.	Overall Length, in.	Finish
65108	8"	Satin Chrome
65112	12"	Satin Chrome



Structural Wrenches Offset Head

Hex Size	Part No.	Overall Length	Head Width, in.	Head Thickness, in.
3/4"	904A	12	1 3/4	13/32
7/8"	905	13	2 9/32	7/16
1 5/16"	906	12	2 9/32	7/16
1"	906B	13	2 9/32	7/16
1 1/16"	907	13 1/2	2 9/32	7/16
1 1/8"	907A	16	2 1/2	19/32
1 1/4"	908	16	2 1/2	19/32
1 5/16"	908A	16	2 1/2	19/32
1 7/16"	909	18	3 1/16	23/32
1 1/2"	909A	18	3 1/16	23/32
1 5/8"	910	20	3 5/8	23/32

Federal Spec. CDA 39-GP-11b U.S. GGG-W-636E.



Pipe Wrenches

Overall Length, in.	Heavy Duty Part No.	Aluminum Part No.	Pipe Capacity, in.
6	NSP6	—	1/8 - 3/4
8	66108	—	1/8 - 1
10	66110	—	1/8 - 1 1/2
12	66112	—	1/4 - 2
14	66114	NSP14A	1/4 - 2
18	66118	NSP18A	1/4 - 2 1/2
24	66124	NSP24A	1/4 - 3
36	66136	NSP36A	1/4 - 5
48	66148	NSP48A	1 - 6

Federal Spec. CDA 39-GP-48A U.S. GGG-W-651C.

C48LR

19 Piece Punch & Chisel Set

Part No.	Description	Size, in.
C2	Flat Chisel	1/2
C3	Flat Chisel	5/8
C4	Flat Chisel	3/4
C5	Flat Chisel	7/8
C6	Flat Chisel	1
C25	Long Taper Punch	5/32
C26	Long Taper Punch	3/16
C32	Prick Punch	3/8
C21	Taper Punch	1/16
C22	Taper Punch	3/32
C23	Taper Punch	1/8
C24	Taper Punch	3/16
C27	Taper Punch	1/4
C28	Pin Punch	1/8
C29	Pin Punch	3/16
C30	Pin Punch	1/4
C31	Pin Punch	5/16
C34	Centre Punch	3/8
C35	Centre Punch	1/2

Packaged in a pouch #2025.

Weight: 5.8 lbs.

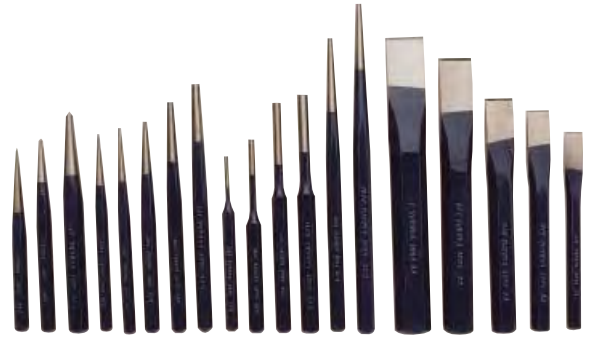

C47LR

25 Piece Punch & Chisel Set

Part No.	Description	Size, in.
C2	Flat Chisel	1/2
C3	Flat Chisel	5/8
C4	Flat Chisel	3/4
C5	Flat Chisel	7/8
C6	Flat Chisel	1
C7	Flat Chisel	1 1/8
C12	Cape Chisel	1/4
C13	Cape Chisel	3/8
C10	Long Flat Chisel	3/4
C15	Diamond Point Chisel	1/4
C16	Diamond Point Chisel	3/8
C18	Round Nose Chisel	1/4
C19	Round Nose Chisel	3/8
C25	Long Taper Punch	5/32
C26	Long Taper Punch	3/16
C32	Prick Punch	3/8
C21	Taper Punch	1/16
C22	Taper Punch	3/32
C23	Taper Punch	1/8
C28	Pin Punch	1/8
C29	Pin Punch	3/16
C30	Pin Punch	1/4
C34	Centre Punch	3/8
C36	Rivet Buster Chisel	7/8
C38	Pinch Bar	5/8

Packaged in a pouch #2024.

Weight: 14.2 lbs.



C46LR

13 Piece Punch & Chisel Set

Part No.	Description	Size, in.
C2	Flat Chisel	1/2
C3	Flat Chisel	5/8
C4	Flat Chisel	3/4
C5	Flat Chisel	7/8
C6	Flat Chisel	1
C12	Cape Chisel	1/4
C15	Diamond Point Chisel	1/4
C25	Long Taper Punch	5/32
C26	Long Taper Punch	3/16
C28	Pin Punch	1/8
C29	Pin Punch	3/16
C30	Pin Punch	1/4
C34	Centre Punch	3/8

Packaged in a pouch #2023.

Weight: 5.0 lbs.

GRAY TOOLS

THERMOMETERS



Thermocouple Probe w/ Mini Plug

Part No.	Description
CK11M	Surface -50 to 250°C
CK13M	Surface -50 to 650°C
FK11M	Chisel Probe -50 to 250°C
GK14M	Air Probe, -40 to 510°C
GK11M	4' Fibreglass, to 1000°C



Test Leads

Part No.	Description
A040	Standard Leads
A050	Standard Lead c/w Alligator Clips
FTLK1	Fused test leads
SDK1C	6 pc. Deluxe Test Lead Set with pouch



Infrared Printer

Part No.	Description
A740B	Battery operated Self test at power on Adjustable contrast Manual paper feed Maximum transmitting distance 16" (45cm) Compatible with most other combustion analyzers Uses common thermal paper Manual paper advance



Close-Focus Pocket-Size Infrared Thermometer

Part No.	Description
87368	Close focus 1/8" - 1.5" -7° to 248°F or -22° to 120°C Easily fits in your pocket Auto Data Hold Min/Max function Continuously scan surface temperatures in real time Auto power off after 10 sec.



Noncontact Infrared Thermometer

Part No.	Description
87373	14° to 950°F Laser sighting 8:1 spot ratio



Digital Pocket Thermometer

Part No.	Description
87310	-58° to 300°F, -5° to 150°C 5" Stem
PDT300	-40° to 300°F, -5° to 150°C 3 1/2" Stem Water Resistant



Infrared Thermometer (With Laser)

Part No.	Description
87381	0° to 500°F (-18° to 260°C) °C and °F selectable 0.1 resolution for best reading Large, easy-to-read LCD 8:1 distance to spot ratio Easy-to-use one button operation



Infrared Thermometer (Without Laser)

Part No.	Description
87380	0° to 500°F (-18° to 260°C) °C and °F selectable 0.1 resolution for best reading Large, easy-to-read LCD 8:1 distance to spot ratio Easy-to-use one button operation

GRAY LEAK DETECTORS & INSPECTION TOOLS



Deluxe Combustible Gas Leak Detector

Part No.	Description
HXG2	Detects as little as 10 ppm Audible & Visual leak indication Settable Alarm 16" Gooseneck

cUL_{US} CAT. III ce



Combustible Gas Leak Detector

Part No.	Description
87720	Detects as little as 50 ppm methane 16" Gooseneck Audible & Visual leak indication Adjustable Sensitivity

cUL_{US} CAT. III ce



Refrigerant Leak Detector

Part No.	Description
87750	Detects all existing blends & refrigerants. Dual Mode: Scan/Normal Adjustable Sensitivity

cUL_{US} CAT. III ce



Deluxe Refrigerant Leak Detector

Part No.	Description
RFC-1	Detects all existing blends & refrigerants. Audible and Visual Alarms Adjustable Sensitivity

cUL_{US} CAT. III ce

Fibre Optic Inspection Tools

Part No.	Cable Dimensions			Handle Dimensions			Overall Length	"Weight (lbs.)"	"Carrying Case Weight (lbs)"
	Length	Dia.	Bend Radius	Length	Width	Height			
87624	24"	5.8mm	3"	6.5"	5.5"	1.5"	30.5"	0.8	2.1
87024	24"	10mm	3"	6.5"	5.5"	1.5"	30.5"	1.0	2.1
87036	36"	5.8mm	3"	6.5"	5.5"	1.5"	42.5"	1.0	2.1
87636	36"	10mm	3"	6.5"	5.5"	1.5"	42.5"	1.3	2.1

All models include carrying case, users manual, batteries and mirror.

Field of View:	45°
Optimal View Min:	.5"
Optimal View Max:	infinite
Lamp Voltage:	6 volts
Power Source:	Double lithium 223 battery pack for 87624 & 87036; 4AA batteries for 87024 & 87636.
Carrying Case:	16.75" x 12.5" x 4" (all models)

Accessories

Part No.	Description
87406	5.8 mm/45 Degree Mirror
87410	10 mm/45 Degree Mirror
87412	Halogen Bulb (5.8 mm models only)



GRAY TOOLS

EXTRACTORS



Straight Type Extractor

Part No.	Screw, stud or bolt size	Use drill size	Min. hole depth	Pipe size
SE50-1	1/4", 5/16"	1/8"	3/8"	—
SE50-2	3/8"	3/16"	1/2"	—
SE50-3	7/16"	15/64"	1/2"	1/8"
SE50-4	1/2", 9/16"	5/16"	1/2"	1/4"
SE50-5	5/8"	3/8"	5/8"	3/8"
SE50-6	3/4"	15/32"	11/16"	—
SE50-7	7/8"	9/16"	11/16"	1/2"
SE50-8	1", 1 1/8"	21/32"	3/4"	1/2"
SE50-9	1 1/4", 1 3/8"	13/16"	3/4"	3/4"



Left-hand Spiral Tapered Flute Extractor

Part No.	Removes screw size	Use drill size
EX1	1/8"-5/32" /3-4mm	5/64" /1.8mm
EX2	3/16"-9/32" /5-7mm	7/64" /2.6mm
EX3	5/16"-3/8" /8-10mm	5/32" /3.7mm
EX4	7/16"-3/8" /11-14mm	1/4" /5.5mm
EX5	3/8"-11/16" /16-18mm	19/64" /7mm
EX6	5/8"-7/8" /16-22mm	13/32" /10mm



No. SE50C 5 Pieces

Straight Type Extractor Set

Contains: SE50-1, SE50-2, SE50-3, SE50-4, SE50-5



No. SE70C 7 Pieces

Straight Type Extractor Set

Contains: SE50-1, SE50-2, SE50-3, SE50-4, SE50-5, SE50-6, SE50-7

Pouch: 100044

No. S35P 5 Pieces

Left Hand Spiral Tapered Flute Extractor Set

Contains: EX1, EX2, EX3, EX4, EX5

Pouch 100068

1/4" HEX SHANK

Slotted	SLOTTED	Insert Bits		Power Bits			
		Size	1" O.A.L.	1-15/16"	3"		
		.032 #4	76114	76124	76134		
		.036 #5	76115	76125	76135		
		.040 #6	76116	76126	76136		
		.046 #8	76118	76128	76138		
		.050 #10	76119	76129	76139		
		.050 #10	—	76120	—		
Robertson	ROBERTSON	Insert Bits		Power Bits			
		Square Size	1" O.A.L.	1-15/16"	2-3/4"	6"	
		#0	76210	76220	—	—	
		#1	76211	76221	76231	76261	
		#2	76212	76222	76232	76262	
#3	76213	76223	76233	76263			
Phillips and Phillips-ACR®	PHILLIPS	Insert Bits		Power Bits			
		Size	1" O.A.L.	1-15/16"	2-3/4"	6"	
		#1	76311	76321	76331	76361	
		#2	76312	76322	76332	76362	
		#3	76313	76323	76333	76363	
		#1 Reduced	76391	—	—	—	
		#2 Reduced	76392	—	—	—	
		#1 ACR	76411	76421	—	—	
#2 ACR	76412	76422	—	—			
#3 ACR	76413	76423	—	—			
Pozidriv®	POZIDRIV®	Insert Bits		Power Bits			
		Size	1" O.A.L.	1-15/16"	2-3/4"	6"	
		#1	76511	—	—	—	
		#2	76512	—	—	—	
#3	76513	—	—	—			
Torx®	TORX®	Insert Bits		Power Bits		TAMPER RESISTANT	
		Size	1" O.A.L.	1 1/4" O.A.L.	1-15/16"		1" O.A.L.
		T6	77106	—	—		—
		T7	77107	—	—		78107
		T8	77108	—	—		78108
		T9	77109	—	—		78109
		T10	77110	—	—		78110
		T15	77115	—	77215		78115
		T20	77120	—	77220		78120
		T25	77125	—	77225		78125
		T27	77127	—	77227		78127
		T30	77130	—	77230		78130
		T40	77140	—	—		78140
T45	—	77345	—	—			
T50	—	77350	—	—			
T55	—	77355	—	—			
T60	—	TX660-BIT	—	—			
Hex Bit	HEX (ALLEN)	SAE Size	Insert Bits 1" O.A.L.	Metric Size	Insert Bits 1" O.A.L.		
		0.050	76610	2 mm	76712		
		1/16	76612	2.5 mm	76712.5		
		3/32	76613	3 mm	76713		
		7/64	76613.5	4 mm	76714		
		1/8	76614	5 mm	76715		
		9/64	76614.5	6 mm	76716		
		5/32	76615	7 mm	76717		
		3/16	76616	8 mm	76718		
		7/32	76617	—	—		

Nut Setter

Nutsetters 1/4" Hex Power Magnetic

Hex Size	1-5/8"	2-9/16"
1/4"	76924	76934
5/16"	76925	76935
3/8"	76926	76936
7/16"	76927	76937



Bit Holders - 1/4" Hex Bits With Ring Retainer

Length	Body Dia.	Magnetic
3"	7/16"	79103 A
2-1/4"	3/8 - 7/16"	79112 B
2-7/8"	3/8"	79102 A
6"	3/8"	79106 A



TAMPER RESISTANT

Part No.	Description
87010	3/8" Keyless Speed-Chuck; removable, replaces key

Round and Square Point Shovels



PRODUCT KEY NUMBER	CATALOG NUMBER	QUALITY	PALLET PKG.	UNIT WEIGHT LB. (KG)	APPROX. NET VOL./UN CU. FT. (CU.M)	HANDLE OR "D" GRIP	HANDLE LENGTH IN. (CM)	BLADE DIMENSIONS IN. (CM)	APPROX. TOT. LENGTH IN. (CM)	REPL. HANDLE	DESCRIPTION		
B	GEX2FD35	99641	Grizzly	3	168	4.65 (2.11)	1.319 (0.037)	Steel	34.75 (88.9)	10 x 12 (25.40 x 30.48)	48 (121.92)	-	Round point shovel, sharpened blade, extra large steps, steel "D" grip for strength and comfort.
C	GEX2FL	99640	Grizzly	3	168	4.56 (2.07)	1.69 (0.048)	Long	48 (121.92)	10 x 12 (25.40 x 30.48)	61.5 (156.21)	-	Round point shovel, sharpened blade, extra large steps.
D	GHR2FD	80375	Grizzly	6	96	4.25 (1.93)	0.303 (0.0086)	Steel	27 3/4 (70.5)	8 5/8 x 11 1/2 (21.9 x 29.2)	41 (104.1)	C4512809	Round point shovel, hollow back tempered steel blade, forward-turned steps, premium ash handle.
E	GHR2FD35	81181	Grizzly	6	96	4.55 (2.06)	0.303 (0.0086)	Steel	34 3/4 (88.3)	8 5/8 x 11 1/2 (21.9 x 29.2)	48 (121.9)	C4513609	Round point shovel, hollow back tempered steel blade, forward-turned steps, premium ash handle.
F	GHR2FL	80377	Grizzly	6	96	4.55 (2.06)	0.365 (0.0103)	Long	48 (121.9)	8 5/8 x 11 1/2 (21.9 x 29.2)	61 (154.9)	C4564809	Round point shovel, hollow back tempered steel blade, forward-turned steps, premium ash handle.
G	GHS2D	81767	Grizzly	3	144	4.48 (2.03)	0.344 (0.0097)	Steel	27 3/4 (70.5)	10 x 12 (25.4 x 30.5)	42 (106.7)	C4512809	Square point shovel, hollow back tempered steel blade, rolled-back steps, premium ash handle.
H	GHS2D35	81869	Grizzly	3	144	5.00 (2.27)	0.344 (0.0097)	Steel	34 3/4 (88.3)	10 x 12 (25.4 x 30.5)	48 (121.9)	C4513609	Square point shovel, hollow back tempered steel blade, rolled-back steps, premium ash handle.
I	GHS2L	81768	Grizzly	3	144	4.69 (2.13)	0.413 (0.0117)	Long	48 (121.9)	10 x 12 (25.4 x 30.5)	61 1/2 (156.2)	C4564809	Square point shovel, hollow back tempered steel blade, rolled-back steps, premium ash handle.



Specialty Shovels



KEY	PRODUCT NUMBER	CATALOG NUMBER	QUALITY	PALLET PKG.	UNIT WEIGHT LB. (KG)	APPROX. NET VOL./UN CU. FT. (CU.M)	HANDLE OR "D" GRIP	HANDLE LENGTH IN. (CM)	BLADE DIMENSIONS IN. (CM)	APPROX. TOT. LENGTH IN. (CM)	REPL. HANDLE	DESCRIPTION	
J	GHS4D	81570	Grizzly	6	96	5.00 (2.27)	0.385 (0.0109)	Steel	27 3/4 (70.5)	10 1/2 x 13 (26.7 x 33.0)	42 (106.7)	C4512809	Square point shovel , hollow back tempered steel blade, rolled-back steps, size 4, premium ash handle.
K	GHSCFL	99423	Grizzly	3	120	2.09 (0.95)	-	Long	42 (106.7)	5 15/16 x 8 1/4 (15.1 x 20.9)	50 (127)	-	Cement form shovel , hollow back tempered steel blade, forward-turned steps, premium ash handle.
L	GHR1FL	81688	Grizzly	3	120	2.60 (1.18)	0.253 (0.0072)	Long	42 (106.7)	6 x 8 3/8 (15.2 x 21.3)	51 3/8 (130.5)	-	Round point shovel , hollow back tempered steel blade, forward-turned steps, premium ash handle.
M	GHFFR1FL	81195	Grizzly	6	192	3.30 (1.50)	0.336 (0.0095)	Long	42 (106.7)	7 5/8 x 10 3/4 (19.4 x 27.3)	55 (139.7)	C4554009	Firefighting shovel , hollow back, tempered and sharpened steel blade, forward-turned steps, premium ash handle.
N	GHDS16FD	81183	Grizzly	3	240	4.10 (1.86)	0.234 (0.0066)	Steel	25 3/4 (65.4)	5 1/2 x 16 (14.0 x 40.6)	45 (114.3)	C4512809	Drain spade , hollow back tempered steel blade, forward-turned steps, premium ash handle.
O	GHGS2FD	81005	Grizzly	6	192	4.00 (1.81)	0.266 (0.0075)	Steel	27 3/4 (70.5)	6 7/8 x 12 (17.5 x 30.5)	40 3/4 (103.5)	C4512809	Garden spade , hollow back tempered steel blade, forward-turned steps, premium ash handle.
P	GHGS5D	80368	Grizzly	3	105	5.50 (2.49)	0.498 (0.0141)	Steel	27 3/4 (70.5)	11 1/8 x 16 1/4 (28.3 x 41.3)	44 1/4 (112.4)	C4512809	Gravel scoop , hollow back tempered steel blade, premium ash handle.
Q	GHRS2D	80163	Grizzly	3	192	4.97 (2.25)	0.266 (0.0075)	Steel	32 3/4 (83.2)	6 7/8 x 10 3/4 (17.5 x 27.3)	47 (119.4)	C4513609	Roofer's spade , tempered notched steel blade, fulcrum welded to back of blade for leverage. Rolled-back steps, premium ash handle.
R	GHRS2L	80164	Grizzly	3	192	5.07 (2.30)	0.328 (0.0093)	Long	48 (121.9)	6 7/8 x 10 3/4 (17.5 x 27.3)	59 (149.9)	C4564809	Roofer's spade , tempered notched steel blade, fulcrum welded to back of blade for leverage. Rolled-back steps, premium ash handle.

Cougar Industrial Tools

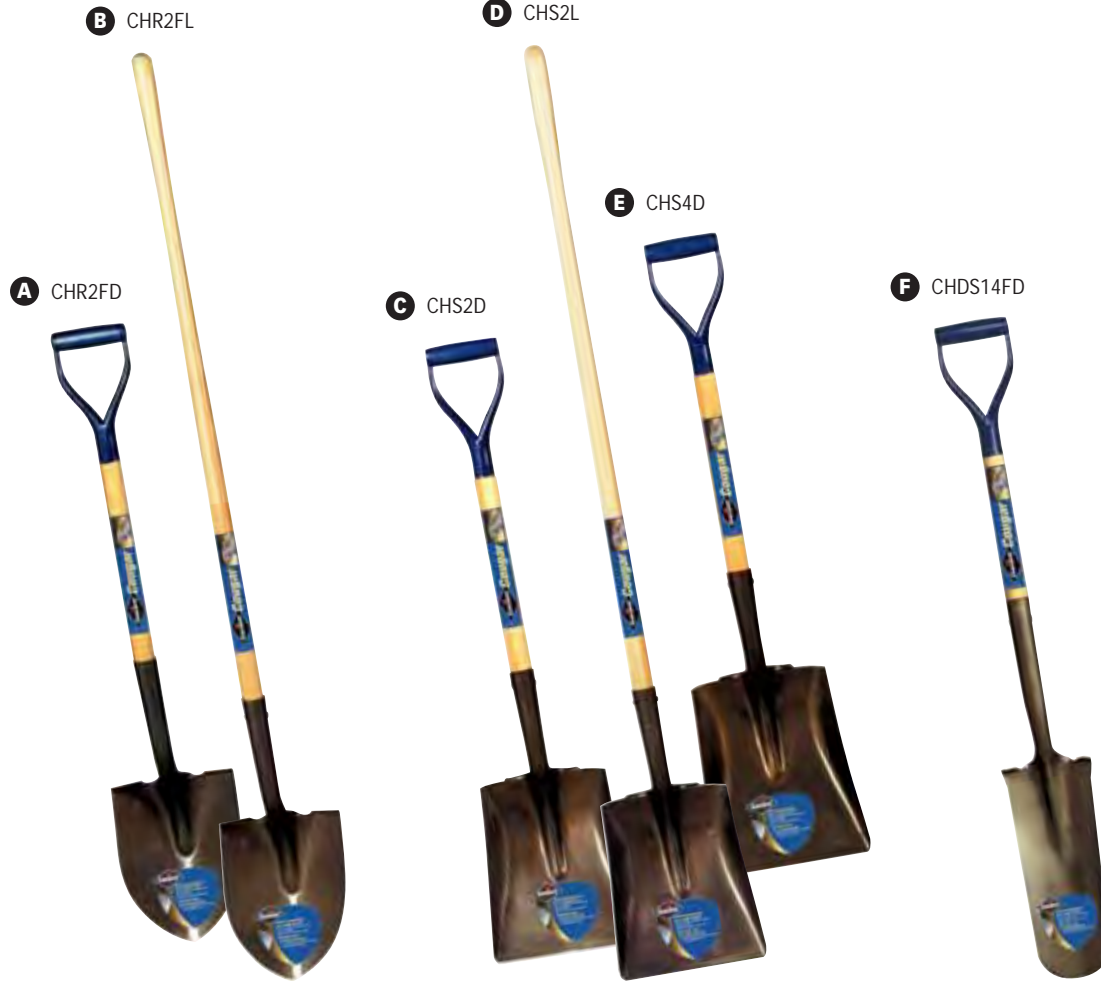

PRODUCT KEY	PRODUCT NUMBER	CATALOG NUMBER	QUALITY	PKG.	PALLET PACK	UNIT WEIGHT LB. (KG)	APPROX. NET VOL./UN CU. FT. (CU.M)	HANDLE OR "D" GRIP	HANDLE LENGTH IN. (CM)	BLADE DIMENSIONS IN. (CM)	APPROX. TOT. LENGTH IN. (CM)	REPL. HANDLE	DESCRIPTION
A	CHR2FD	81208	Cougar	6	96	4.13 (1.87)	0.303 (0.0086)	Steel "D"	27-3/4 (70.5)	8-5/8 x 11-1/2 (21.9 x 29.2)	41-1/2 (105.4)	C4512809	Round point shovel, hollow back tempered steel blade, forward-turned steps, hardwood handle.
B	CHR2FL	81209	Cougar	6	96	4.26 (1.93)	0.365 (0.0103)	Long	46 (116.8)	8-5/8 x 11-1/2 (21.9 x 29.2)	61-3/4 (156.8)	C4564809	Round point shovel, hollow back tempered steel blade, forward-turned steps, hardwood handle.
C	CHS2D	81765	Cougar	6	144	5.00 (2.27)	0.344 (0.0097)	Steel "D"	27-3/4 (70.5)	10 x 12 (25.4 x 30.5)	41 (104.1)	C4512809	Square point shovel, hollow back tempered steel blade, forward-turned steps, hardwood handle.
D	CHS2L	81766	Cougar	6	144	5.00 (2.27)	0.413 (0.0117)	Long	46 (116.8)	10 x 12 (25.4 x 30.5)	61 (154.9)	C4564809	Square point shovel, hollow back tempered steel blade, forward-turned steps, hardwood handle.
E	CHS4D	81211	Cougar	6	144	5.13 (2.32)	0.385 (0.0109)	Steel "D"	27-3/4 (70.5)	10-1/2 x 13 (20.7 x 33.0)	42-1/2 (108.0)	C4512809	Square point shovel, hollow back tempered steel blade, size 4, hardwood handle.
F	CHDS14FD	81215	Cougar	3	240	3.80 (1.72)	0.220 (0.0063)	Steel "D"	27-3/4 (70.5)	5-1/2 x 14 (14.0 x 35.6)	43-3/4 (111.1)	C4512809	Drain spade, hollow back tempered steel blade, forward-turned steps, hardwood handle.

Forged Steel Shovels



Spot-welded steel "D" grip for strength and comfort.



PRODUCT KEY	CATALOG NUMBER	QUALITY	PALLET PKG.	UNIT WEIGHT LB. (KG)	APPROX. NET VOL./UN CU. FT. (CU.M)	HANDLE OR "D" GRIP	HANDLE LENGTH IN. (CM)	BLADE DIMENSIONS IN. (CM)	APPROX. TOT. LENGTH IN. (CM)	REPL. HANDLE	DESCRIPTION		
A	GIFR2FD	81188	Grizzly	3	192	4.48 (2.03)	0.210 (0.0059)	Steel	25 1/2 (64.8)	8 3/4 x 11 1/4 (22.2 x 28.6)	39 1/2 (100.3)	C4512409	Round point shovel , solid shank and tempered steel blade, forward-turned steps, premium ash handle. Longer socket for better shovel balance.
B	GIFR2FL	81189	Grizzly	3	192	4.83 (2.19)	0.278 (0.0079)	Long	48 (121.9)	8 3/4 x 11 1/4 (22.2 x 28.6)	62 (157.5)	C4564809	Round point shovel , solid shank and tempered steel blade, forward-turned steps, premium ash handle. Longer socket for better shovel balance.
C	GIFS2FD	81192	Grizzly	3	192	4.90 (2.22)	0.327 (0.0093)	Steel	25 1/2 (64.8)	9 5/8 x 11 1/2 (24.5 x 29.2)	40 (101.6)	C4512409	Square point shovel , solid shank and tempered steel blade, forward-turned steps, premium ash handle. Longer socket for better shovel balance.
D	GIFS2FL	81193	Grizzly	3	216	5.20 (2.36)	0.308 (0.0087)	Long	48 (121.9)	9 5/8 x 11 1/2 (24.5 x 29.2)	61 1/2 (156.2)	C4564809	Square point shovel , solid shank and tempered steel blade, forward-turned steps, premium ash handle. Longer socket for better shovel balance.
E	GFGS2FD	81194	Grizzly	3	192	4.50 (2.04)	0.253 (0.0072)	Steel	25 1/2 (64.8)	7 1/8 x 11 3/4 (18.1 x 29.8)	41 1/4 (104.8)	C4512409	Garden spade , solid shank and tempered steel blade, forward-turned steps, premium ash handle.
F	GFGS2FL	80506	Grizzly	3	192	4.70 (2.13)	0.334 (0.0095)	Long	48 (121.9)	7 1/8 x 11 3/4 (18.1 x 29.8)	63 1/4 (160.7)	C4564809	Garden spade , solid shank and tempered steel blade, forward-turned steps, premium ash handle.
G	GFDS14D	80356	Grizzly	3	240	5.20 (2.36)	0.220 (0.0062)	Steel	25 1/2 (64.8)	5 1/2 x 14 (14.0 x 35.6)	43 1/2 (110.5)	C4512409	Drain spade , solid shank and tempered steel blade, forward-turned steps, premium ash handle.



Forged Steel Shovels



Spot-welded steel "D" grip for strength and comfort.



KEY	PRODUCT NUMBER	CATALOG NUMBER	QUALITY	PKG.	PALLET PACK	UNIT WEIGHT LB. (KG)	APPROX. NET VOL./UN CU. FT. (CU.M)	HANDLE OR "D" GRIP	HANDLE LENGTH IN. (CM)	BLADE DIMENSIONS IN. (CM)	APPROX. TOT. LENGTH IN. (CM)	REPL. HANDLE	DESCRIPTION
H	GIFR2D	81185	Grizzly	3	216	4.40 (2.00)	0.210 (0.0059)	Steel	25 1/2 (64.8)	8 3/4 x 11 1/4 (22.2 x 28.6)	39 1/2 (100.3)	C4512409	Round point shovel , solid shank and tempered steel blade, premium ash handle.
I	GIFR2L	81186	Grizzly	3	192	4.40 (2.00)	0.278 (0.0079)	Long	48 (121.9)	8 3/4 x 11 1/4 (22.2 x 28.6)	61 3/4 (156.8)	C4564809	Round point shovel , solid shank and tempered steel blade, premium ash handle.
J	GIFS2D	81190	Grizzly	3	192	5.50 (2.49)	0.327 (0.0093)	Steel	25 1/2 (64.8)	9 1/2 x 12 (24.1 x 30.5)	39 1/2 (100.3)	C4512409	Square point shovel , solid shank and tempered steel blade, premium ash handle.
K	GIFS2L	81191	Grizzly	3	216	5.70 (2.59)	0.308 (0.0087)	Long	48 (121.9)	9 1/2 x 12 (24.1 x 30.5)	61 3/4 (156.8)	C4564809	Square point shovel , solid shank and tempered steel blade, premium ash handle.
L	GFR2NL	81187	Grizzly	3	192	5.50 (2.49)	0.384 (0.0109)	Long	48 (121.9)	8 1/4 x 12 (21.0 x 30.5)	62 1/4 (158.1)	C4564809	Round point shovel , solid shank and tempered steel blade, premium ash handle.

Heavy-duty, electric-welded steel "D" grip for strength and comfort.



PRODUCT KEY	CATALOG NUMBER	QUALITY	PKG.	PALLET PACK	UNIT WEIGHT LB. (KG)	APPROX. NET VOL./UN CU. FT. (CU.M)	HANDLE OR "D" GRIP	HANDLE LENGTH IN. (CM)	BLADE DIMENSIONS IN. (CM)	APPROX. TOT. LENGTH IN. (CM)	REPL. HANDLE	DESCRIPTION	
A	GFR2D	80361	Grizzly	3	192	5.40 (2.45)	0.303 (0.0086)	Steel	25 1/2 (64.8)	9 x 12 1/4 (22.9 x 31.1)	40 1/2 (102.9)	C4512409	Round point shovel, solid shank and forged steel blade, premium ash handle.
B	GFR2D35	80364	Grizzly	3	192	5.70 (2.59)	0.309 (0.0087)	Steel	34 3/4 (88.3)	9 x 12 1/4 (22.9 x 31.1)	49 3/4 (126.4)	C4513609	Round point shovel, solid shank and forged steel blade, premium ash handle.
C	GFR2L	80365	Grizzly	3	216	5.11 (2.32)	0.293 (0.0083)	Long	48 (121.9)	9 x 12 1/4 (22.9 x 31.1)	62 3/4 (159.4)	C4564809	Round point shovel, solid shank and forged steel blade, premium ash handle.
D	GFS2D	80366	Grizzly	3	144	5.50 (2.49)	0.327 (0.0093)	Steel	25 1/2 (64.8)	9 1/2 x 12 (24.1 x 30.5)	40 (101.6)	C4512409	Square point shovel, solid shank and forged steel blade, premium ash handle.
E	GFS2D35	80447	Grizzly	3	192	5.80 (2.63)	0.327 (0.0093)	Steel	34 3/4 (88.3)	9 1/2 x 12 (24.1 x 30.5)	49 1/4 (125.1)	C4513609	Square point shovel, solid shank and forged steel blade, premium ash handle.
F	GFS2L	80367	Grizzly	3	216	5.70 (2.59)	0.308 (0.0087)	Long	48 (121.9)	9 1/2 x 12 (24.1 x 30.5)	62 1/4 (158.1)	C4564809	Square point shovel, solid shank and forged steel blade, premium ash handle.



Specialty Forged Steel Shovels



KEY	PRODUCT NUMBER	CATALOG NUMBER	QUALITY	PKG.	PALLET PACK	UNIT WEIGHT LB. (KG)	APPROX. NET VOL./UN CU. FT. (CU.M)	HANDLE OR "D" GRIP	HANDLE LENGTH IN. (CM)	BLADE DIMENSIONS IN. (CM)	APPROX. TOT. LENGTH IN. (CM)	REPL. HANDLE	DESCRIPTION
G	GFPS08	80443	Grizzly	1	-	8.10 (3.67)	1.167 (0.0330)	Long	96 (243.8)	9 x 10 3/4 (22.9 x 27.3)	106 (269.2)	F9508	Post hole spoons , solid shanks and tempered steel blades, ash handles.
	GFPS09	80444	Grizzly	1	-	8.80 (3.99)	1.313 (0.0372)		108 (274.3)	9 x 10 3/4 (22.9 x 27.3)	118 (299.7)	F9509	
	GFPS10	80445	Grizzly	1	-	9.50 (4.31)	1.459 (0.0413)		120 (304.8)	9 x 10 3/4 (22.9 x 27.3)	130 (330.2)	F9510	
	GFPS12	80446	Grizzly	1	-	10.80 (4.90)	1.750 (0.0496)		144 (365.8)	9 x 10 3/4 (22.9 x 27.3)	154 (391.2)	F9512	
H	GFTS2D	80454	Grizzly	6	192	5.60 (2.54)	0.327 (0.0093)	Steel	25 1/2 (64.8)	9 3/4 x 11 3/4 (24.8 x 29.8)	39 1/2 (100.3)	C4512409	Square point railroad track shovel , solid shank and tempered steel blade, forward-turned steps, premium ash handle.
I	GFFR1D	80440	Grizzly	6	240	4.40 (2.00)	0.176 (0.0050)	Steel	25 1/2 (64.8)	7 1/4 x 10 1/2 (18.4 x 26.7)	37 1/2 (95.3)	C4512409	Firefighting shovel , solid shank, tempered and sharpened steel blade, premium ash handle.
J	GFFR1L	80441	Grizzly	6	270	4.30 (1.95)	0.195 (0.0055)	Long	40 (101.6)	7 1/4 x 10 1/2 (18.4 x 26.7)	50 (127.0)	C4554009	Firefighting shovel , solid shank, tempered and sharpened steel blade, premium ash handle.



GRAIN & COAL SCOOPS



Heavy-duty poly blade has ribbed design for added stiffness and strength.

KEY	PRODUCT NUMBER	CATALOG NUMBER	QUALITY	PKG.	PALLET PACK	UNIT WEIGHT LB. (KG)	APPROX. NET VOL./UN CU. FT. (CU. M)	HANDLE OR D-GRIP	HANDLE LENGTH IN. (CM)	BLADE DIMENSIONS IN. (CM)	APPROX. TOT. LENGTH IN. (CM)	REPL. HANDLE	DESCRIPTION
F	SPG12D	81720	PRACTICA	3	84	3.10 (1.41)	0.746 (0.0211)	POLY RIBBED	30 1/4 (76.8)	14 1/2 × 18 1/2 (36.8 × 47.0)	46 (116.8)	C4622809	Grain scoop, black poly blade, green ribbed D-grip, hardwood handle.
G	GPG12D	80030	GRIZZLY	3	84	3.50 (1.59)	0.746 (0.0211)	POLY POWER D	30 1/4 (76.8)	14 1/2 × 18 1/2 (36.8 × 47.0)	46 (116.8)	C4622809	Grain scoop, grey poly blade, premium ash handle.
H	GPG12L	80080	GRIZZLY	3	84	4.68 (2.12)	0.746 (0.0211)	LONG	48 (121.9)	14 1/2 × 18 1/2 (36.8 × 47.0)	61 1/2 (156.2)	C4564809	Grain scoop, grey poly blade, premium ash handle.
I	GSG02D	80040	GRIZZLY	3	84	5.45 (2.47)	0.545 (0.0154)	STEEL	27 3/4 (70.5)	11 1/4 × 15 1/2 (28.6 × 39.4)	42 1/4 (107.3)	C4622809	Coal scoop, stampered and tempered steel blade, premium ash handle.
-	GSG04D	80041	GRIZZLY	3	84	5.65 (2.56)	0.545 (0.0154)	STEEL	27 3/4 (70.5)	11 1/2 × 16 1/4 (29.2 × 41.3)	42 3/4 (108.6)	C4622809	Coal scoop, stampered and tempered steel blade, premium ash handle.
J	GSG04L	80082	GRIZZLY	3	84	5.95 (2.70)	0.671 (0.0190)	LONG	48 (121.9)	11 1/2 × 16 1/4 (29.2 × 41.3)	63 (160.0)	C4564809	Coal scoop, stampered and tempered steel blade, premium ash handle.
K	GSG06D	80042	GRIZZLY	3	84	5.89 (2.67)	0.545 (0.0154)	STEEL	27 3/4 (70.5)	12 × 17 3/8 (30.5 × 44.1)	43 1/2 (110.5)	C4622809	Coal scoop, stampered and tempered steel blade, premium ash handle.
-	GSG08D	80043	GRIZZLY	3	84	6.57 (2.98)	0.559 (0.0158)	STEEL	27 3/4 (70.5)	14 1/4 × 16 1/2 (36.2 × 41.9)	42 1/2 (108.0)	C4622809	Coal scoop, stampered and tempered steel blade, premium ash handle.
-	GSG10D	80481	GRIZZLY	3	84	7.09 (3.22)	0.559 (0.0158)	STEEL	27 3/4 (70.5)	14 5/8 × 17 3/4 (37.1 × 45.1)	43 1/4 (109.9)	C4622809	Coal scoop, stampered and tempered steel blade, premium ash



GRAIN & COAL SCOOPS

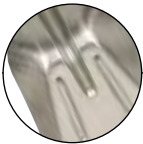

Strong aluminum blade has ribbed design for strength and durability.

KEY	PRODUCT NUMBER	CATALOG NUMBER	QUALITY	PKG.	PALLET PACK	UNIT WEIGHT LB. (KG)	APPROX. NET VOL./UN CU. FT. (CU. M)	HANDLE OR D-GRIP	HANDLE LENGTH IN. (CM)	BLADE DIMENSIONS IN. (CM)	APPROX. TOT. LENGTH IN. (CM)	REPL. HANDLE	DESCRIPTION
A	LAG08D	81715	ECONO	3	84	3.40 (1.54)	0.651 (0.0184)	POLY RIBBED	28 1/4 (71.8)	13 × 17 3/8 (33.0 × 44.1)	45 (114.3)	C4622809	Grain scoop, aluminum blade, natural finish, hardwood handle.
-	LAG10D	81717	ECONO	3	84	3.50 (1.60)	0.667 (0.0189)	POLY RIBBED	28 1/4 (71.8)	13 3/8 × 18 1/4 (34.0 × 46.4)	45 1/2 (115.6)	C4622809	Grain scoop, aluminum blade, natural finish, hardwood handle.
-	LAG12D	81718	ECONO	3	84	3.60 (1.63)	0.708 (0.0200)	POLY RIBBED	28 1/4 (71.8)	15 × 18 3/4 (38.1 × 47.6)	45 1/2 (115.6)	C4622809	Grain scoop, aluminum blade, natural finish, hardwood handle.
-	LAG14D	81719	ECONO	3	84	3.70 (1.68)	0.742 (0.0210)	POLY RIBBED	28 1/4 (71.8)	15 1/2 × 19 3/4 (39.4 × 50.2)	46 (116.8)	C4622809	Grain scoop, aluminum blade, natural finish, hardwood handle.
B	LAG08L	81716	ECONO	3	84	3.80 (1.72)	0.720 (0.0204)	LONG	48 (121.9)	13 × 17 3/8 (33.0 × 44.1)	63 1/2 (161.3)	C4564809	Grain scoop, aluminum blade, natural finish, hardwood handle.
C	GAG08D	80012	GRIZZLY	3	84	3.90 (1.77)	0.651 (0.0184)	STEEL	27 3/4 (70.5)	13 × 17 3/8 (33.0 × 44.1)	44 (111.8)	C4622809	Grain scoop, aluminum blade, natural finish, premium varnished ash handle.
-	GAG10D	80015	GRIZZLY	3	84	4.20 (1.91)	0.667 (0.0189)	STEEL	27 3/4 (70.5)	13 3/8 × 18 1/4 (34.0 × 46.4)	44 3/4 (113.7)	C4622809	Grain scoop, aluminum blade, natural finish, premium varnished ash handle.
D	GAG08D35	80014	GRIZZLY	3	84	4.20 (1.91)	0.651 (0.0184)	STEEL	34 3/4 (88.3)	13 × 17 3/8 (33.0 × 44.12)	51 (129.5)	-	Grain scoop, aluminum blade, natural finish, premium varnished ash handle.
-	GAG10D35	80017	GRIZZLY	3	84	4.50 (2.04)	0.667 (0.0189)	STEEL	34 3/4 (88.3)	13 3/8 × 18 1/4 (34.0 × 46.4)	51 3/4 (131.4)	-	Grain scoop, aluminum blade, natural finish, premium varnished ash handle.
E	GAG10L	80079	GRIZZLY	3	84	4.30 (1.95)	0.720 (0.0204)	LONG	48 (121.9)	13 3/8 × 18 1/4 (34.0 × 46.4)	64 3/4 (164.5)	C4564809	G



STEEL SHOVELS

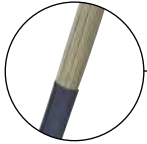

KEY	PRODUCT NUMBER	CATALOG NUMBER	QUALITY	PKG.	PALLET PACK	UNIT WEIGHT LB. (KG)	APPROX. NET VOL./UN CU. FT. (CU. M)	HANDLE OR D-GRIP	HANDLE LENGTH IN. (CM)	BLADE DIMENSIONS IN. (CM)	APPROX. TOT. LENGTH IN. (CM)	REPL. HANDLE	DESCRIPTION
A	YHS6D	80646	YUKON	3	144	6.00 (2.72)	0.498 (0.0141)	STEEL	34 3/4 (88.3)	11 1/2 × 14 1/2 (29.2 × 36.8)	50 1/2 (128.3)	C4513609	All-purpose shovel, industrial grade, stamped and tempered steel blade, varnished ash handle.
B	AS112D	80639	ALPINE	3	144	5.00 (2.27)	0.422 (0.0119)	STEEL	34 3/4 (88.3)	11 1/4 × 13 3/4 (28.6 × 34.9)	47 (119.4)	C4513609	All-purpose shovel, stamped steel blade, stained ash handle.
C	NS112D	80636	NORDIC	6	144	4.60 (2.09)	0.422 (0.0119)	POLY RIBBED	32 1/4 (81.9)	11 1/4 × 13 3/4 (28.6 × 34.9)	44 1/2 (113.0)	C4513609	All-purpose shovel, stamped steel blade, stained ash handle.
D	NS112L	80635	NORDIC	6	144	4.80 (2.18)	0.504 (0.0143)	LONG	48 (121.9)	11 1/4 × 13 3/4 (28.6 × 34.9)	59 3/4 (151.8)	C4564809	All-purpose shovel, stamped steel blade, stained ash handle.
E	LS110D	80625	LYNX	6	144	3.70 (1.68)	0.404 (0.0114)	POLY DOUGL					



ALUMINUM SNOW SHOVELS



Ribbed design provides added strength and stiffness.

KEY	PRODUCT NUMBER	CATALOG NUMBER	QUALITY	PKG.	PALLET PACK	UNIT WEIGHT LB. (KG)	APPROX. NET VOL./UN CU. FT. (CU. M)	HANDLE OR D-GRIP	HANDLE LENGTH IN. (CM)	BLADE DIMENSIONS IN. (CM)	APPROX. TOT. LENGTH IN. (CM)	REPL. HANDLE	DESCRIPTION
A	IA102DSR	81999	YUKON	3	144	2.28 (1.03)	0.278 (0.0078)	POLY POWER D	18 3/4 (47.6)	10 1/4 × 12 1/4 (26.0 × 31.1)	30 1/4 (76.8)	—	Survival/rescue shovel, aluminum blade, ash handle.
B	YA115D	80642	YUKON	6	144	3.70 (1.68)	0.435 (0.0123)	STEEL	34 3/4 (88.3)	11 1/2 × 14 3/8 (29.2 × 36.5)	48 1/2 (123.2)	C4513609	Snow shovel, industrial grade, aluminum blade, lacquered ash handle.
C	YA115L	80643	YUKON	6	144	3.60 (1.64)	0.504 (0.0143)	LONG	48 (121.9)	11 1/2 × 14 3/8 (29.2 × 36.5)	61 1/2 (156.2)	C4564809	Snow shovel, industrial grade, aluminum blade, lacquered ash handle.
D	YA135DS	80644	YUKON	3	84	3.59 (1.63)	0.529 (0.0150)	STEEL	34 3/4 (88.3)	13 1/2 × 14 (34.3 × 35.6)	48 (121.9)	C4513609	Street/snow shovel, blue aluminum blade, lacquered ash handle.
E	YA135LS	80645	YUKON	3	84	3.54 (1.61)	0.661 (0.0187)	LONG	48 (121.9)	13 1/2 × 14 (34.3 × 35.6)	61 (154.9)	C4564809	Street/snow shovel, blue aluminum blade, lacquered ash handle.



ICE SCRAPERS

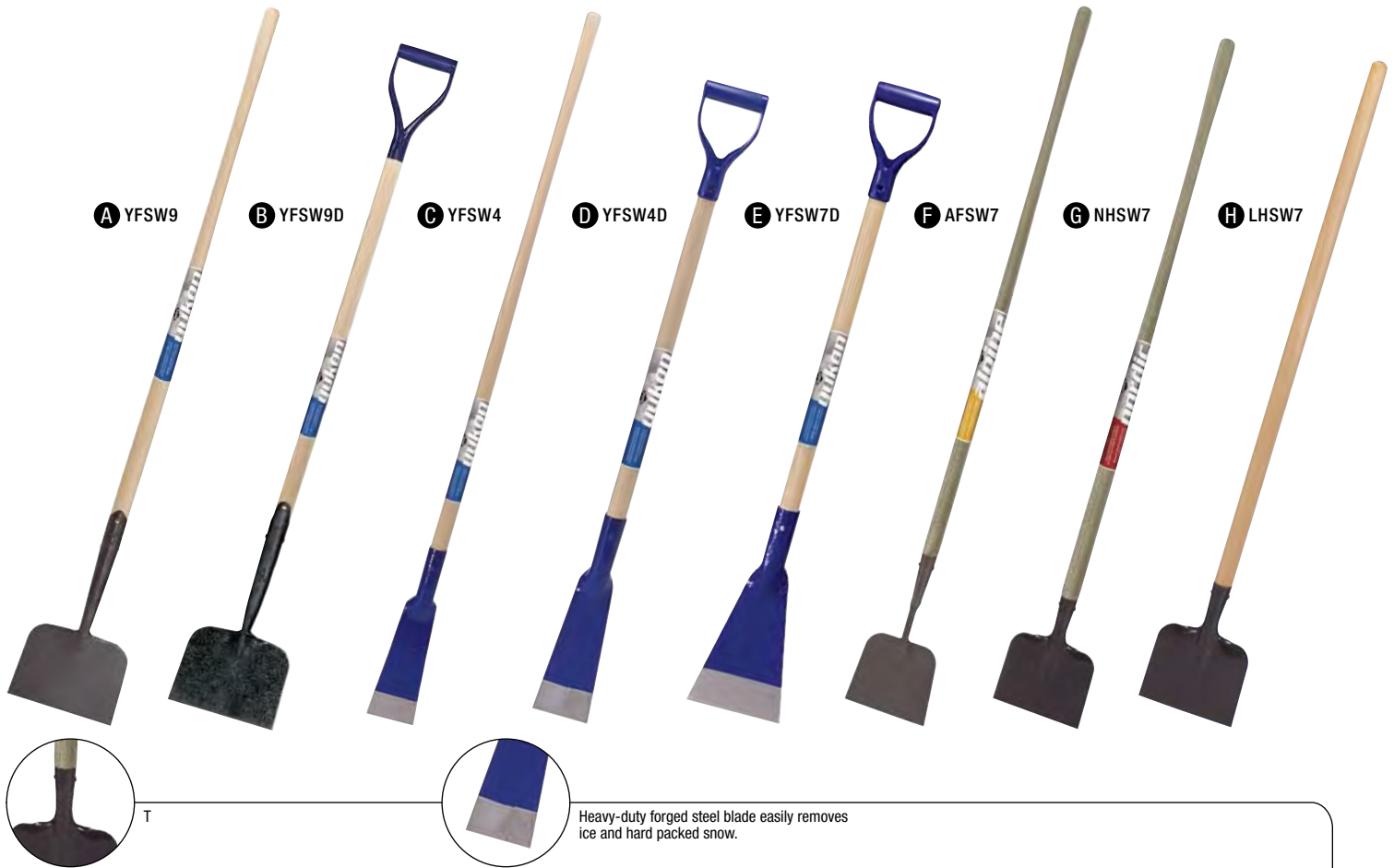

Heavy-duty forged steel blade easily removes ice and hard packed snow.

KEY	PRODUCT NUMBER	CATALOG NUMBER	QUALITY	PKG.	PALLET PACK	UNIT WEIGHT LB. (KG)	APPROX. NET VOL./UN CU. FT. (CU. M)	HANDLE OR D-GRIP	HANDLE LENGTH IN. (CM)	BLADE DIMENSIONS IN. (CM)	APPROX. TOT. LENGTH IN. (CM)	REPL. HANDLE	DESCRIPTION
A	YFSW9	80657	YUKON	3	144	4.40 (2.00)	0.162 (0.0046)	LONG	48 (121.9)	6 1/4 × 8 1/2 (15.9 × 21.6)	58 1/4 (148.0)	C4564809	Sidewalk scraper with industrial grade, forged and tempered steel blade, varnished profiled ash handle.
B	YFSW9D	81761	YUKON	3	144	5.20 (2.35)	0.225 (0.0063)	STEEL	42 3/4 (108.6)	6 1/4 × 8 1/2 (15.9 × 21.6)	52 1/2 (133.3)	-	Sidewalk scraper with industrial grade, forged and tempered steel blade, varnished ash handle with steel YD-grip.
C	YFSW4	81687	YUKON	3	144	4.39 (1.99)	0.122 (0.0034)	LONG	48 (121.9)	3 3/4 × 14 (9.5 × 35.6)	57 1/2 (146.0)	C4564809	Sidewalk scraper with industrial grade, forged and tempered steel blade, varnished ash handle.
D	YFSW4D	81686	YUKON	3	144	4.09 (1.85)	0.225 (0.0063)	POLY POWER D	35 (88.9)	3 3/4 × 14 (9.5 × 35.6)	44 1/2 (113.0)	-	Sidewalk scraper with industrial grade, forged and tempered steel blade, varnished ash handle.
E	YFSW7D	81880	YUKON	3	144	4.80 (2.18)	0.225 (0.0063)	POLY POWER D	35 (88.9)	6 1/2 × 14 (16.5 × 36.6)	44 1/2 (113.0)	-	Sidewalk scraper with industrial grade, forged and tempered steel blade, varnished ash handle.
F	AFSW7	80641	ALPINE	3	144	3.25 (1.47)	0.102 (0.0028)	LONG	48 (121.9)	6 × 7 (15.2 × 17.8)	58 1/4 (148.0)	C4564809	Sidewalk scraper with forged and tempered steel blade with stained ash profiled handle.
G	NHSW7	80637	NORDIC	6	144	2.70 (1.22)	0.110 (0.0031)	LONG	48 (121.9)	5 1/2 × 7 (14.0 × 17.8)	53 1/2 (135.9)	C4564809	Sidewalk scraper with stamped steel blade and stained ash profiled handle.
H	LHSW7	80631	LYNX	6	144	2.50 (1.13)	0.110 (0.0031)	LONG	42 (106.7)	5 1/2 × 7 (14.0 × 17.8)	47 1/2 (120.7)	C4564809	Sidewalk scraper with stamped steel blade and hardwood straight handle.



STEEL SNOW PUSHERS

Steel-back braces on snow pushers provide added strength and rigidity.



KEY	PRODUCT NUMBER	CATALOG NUMBER	QUALITY	PKG.	PALLET PACK	UNIT WEIGHT LB. (KG)	APPROX. NET VOL./UN CU. FT. (CU. M)	HANDLE OR D-GRIP	HANDLE LENGTH IN. (CM)	BLADE DIMENSIONS IN. (CM)	APPROX. TOT. LENGTH IN. (CM)	REPL. HANDLE	DESCRIPTION
A	YSP18L	80648	YUKON	3	72	5.70 (2.59)	1.319 (0.0374)	LONG	48 (121.9)	12 x 18 (30.5 x 45.7)	59 (149.9)	C4564809	Snow pusher, blue steel blade, varnished ash handle.
B	YSP24D	80649	YUKON	3	36	7.50 (3.40)	1.418 (0.0402)	STEEL	42 3/4 (108.6)	12 x 24 (30.5 X 61.0)	54 (137.2)	03043RG	Snow pusher, blue steel blade, varnished ash handle.
C	YSP24L	80650	YUKON	3	36	6.90 (3.13)	1.418 (0.0402)	LONG	48 (121.9)	12 x 24 (30.5 x 61.0)	59 (149.9)	C4564809	Snow pusher, blue steel blade, varnished ash handle.
D	YSP30D	80651	YUKON	3	36	8.70 (3.95)	2.708 (0.0767)	STEEL	42 3/4 (108.6)	12 x 30 (30.5 x 76.2)	54 (137.2)	03043RG	Snow pusher, blue steel blade, varnished ash handle.
E	YSP30L	80652	YUKON	3	36	8.10 (3.67)	2.708 (0.0767)	LONG	48 (121.9)	12 x 30 (30.5 x 76.2)	59 (149.9)	C4564809	Snow pusher, blue steel blade, varnished ash handle.
F	NSP24D	80973	NORDIC	3	144	6.30 (2.85)	0.806 (0.0228)	POLY RIBBED	40 1/2 (102.9)	10 x 24 (25.4 x 61.0)	51 (129.5)	03043RG	



ALUMINUM SNOW SHOVELS



A YAP24DR

B YAP24LR

C NAP24D

D NAP24L

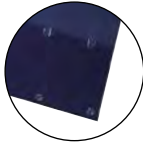

Heavy-duty, no-rust aluminum blade with strip, designed for continuous use.

KEY	PRODUCT NUMBER	CATALOG NUMBER	QUALITY	PKG.	PALLET PACK	UNIT WEIGHT LB. (KG)	APPROX. NET VOL./UN CU. FT. (CU. M)	HANDLE OR D-GRIP	HANDLE LENGTH IN. (CM)	BLADE DIMENSIONS IN. (CM)	APPROX. TOT. LENGTH IN. (CM)	REPL. HANDLE	DESCRIPTION
A	YAP24DR	80654	YUKON	3	36	5.80 (2.63)	1.418 (0.0402)	STEEL	42 3/4 (108.6)	12 × 24 (30.5 × 61.0)	53 3/4 (136.5)	03043RG	Snow pusher, blue aluminum blade with steel wear strip, lacquered ash handle.
B	YAP24LR	80655	YUKON	3	48	5.20 (2.36)	1.418 (0.0402)	LONG	48 (121.9)	12 × 24 (30.5 × 61.0)	59 (150.0)	C4564809	Snow pusher, blue aluminum blade with steel wear strip, lacquered ash handle.
C	NAP24D	80632	NORDIC	3	72	3.90 (1.77)	0.806 (0.0228)	POLY RIBBED	40 1/4 (102.2)	10 × 24 (25.4 × 61.0)	50 3/4 (128.9)	03043RG	Snow pusher, paint aluminum blade, stained ash handle.
D	NAP24L	80633	NORDIC	3	72	3.90 (1.77)	0.806 (0.0228)	LONG	48 (121.9)	10 × 24 (25.4 × 61.0)	58 1/2 (148.6)	C4564809	Snow pusher, paint aluminum blade, stained ash handle.



ERGONOMIC POLY SNOW SHOVELS & PUSHERS

A YEMECAR



B YP139EAKD
YP139EAKDV



C YPM18EAKD
YPM18EAKDV



D YM18EAKDVS



Display box,
1/4 pallet pack.



Ergo grip.



VersaGrip™

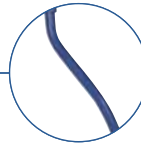

Ergonomic aluminum
handle that prevents
back strain, strong
and lightweight.

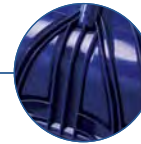

Extra support ribs
on back of blade provide
added strength and
stiffness.

KEY	PRODUCT NUMBER	CATALOG NUMBER	QUALITY	PKG.	PALLET PACK	UNIT WEIGHT LB. (KG)	APPROX. NET VOL./UN CU. FT. (CU. M)	HANDLE OR D-GRIP	HANDLE LENGTH IN. (CM)	BLADE DIMENSIONS IN. (CM)	APPROX. TOT. LENGTH IN. (CM)	REPL. HANDLE	DESCRIPTION
A	YEMECAR	99114	YUKON	12		1.65 (0.75)	0.25 (0.0071)	POLY	14 (35.6)	12 1/4 × 8 3/4 (31.1 × 22.2)	30 (16.2)	–	Emergency car shovel, blue poly blade with reinforced central rib, telescopic aluminum handle. Ideal to shovel snow around the car and perfect to store under your seat or in the trunk.
B	YP139EAKD	78520	YUKON ERGO	6	72	3.03 (1.37)	0.592 (0.0167)	POLY ERGO	45 (114.3)	13 7/8 × 16 3/4 (35.2 × 42.6)	54 3/4 (139.1)	–	Snow shovel, blue poly blade, ergonomic lightweight aluminum handle.
–	YP139EAKDV	785207	YUKON ERGO	20	80	3.03 (1.37)	–	POLY ERGO	45 (114.3)	13 7/8 × 16 3/4 (35.2 × 42.6)	54 3/4 (139.1)	–	Same as YP139EAKD, but delivered in a display box.
C	YPM18EAKD	78521	YUKON ERGO	6	90	3.29 (1.49)	0.648 (0.0183)	POLY ERGO	43 1/2 (110.5)	13 1/2 × 18 (34.3 × 45.7)	53 (134.6)	–	Snow Mountain Mover, blue poly blade, ergonomic lightweight aluminum handle.
–	YPM18EAKDV	785217	YUKON ERGO	20	80	3.29 (1.49)	–	POLY ERGO	43 1/2 (110.5)	13 1/2 × 18 (34.3 × 45.7)	53 (134.6)	–	Same as YPM18EAKD, but delivered in a display box.
D	YM18EAKDVS	99069	YUKON ERGO	6	72	4.5 (2.04)	0.833 (0.0236)	POLY VERSA-GRIP™	44 (111.8)	13 1/2 × 18 (34.3 × 45.7)	53 3/4 (136.5)	–	Snow Mountain Mover, blue poly blade, ergonomic lightweight aluminum handle, VersaGrip™.



ERGONOMIC POLY SNOW SHOVELS & PUSHERS



E YPP21EAKD



F YP21EAKDVS



G YPP24SAKD
YPP24SAKDV

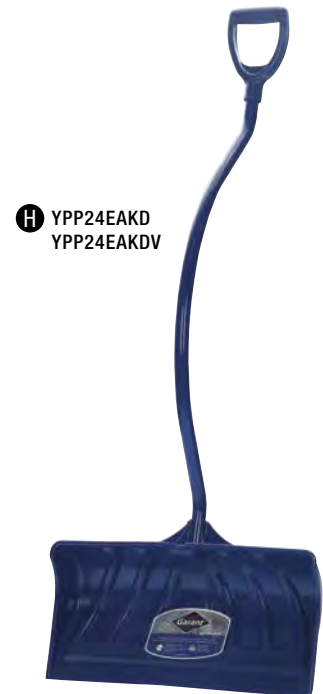

H YPP24EAKD
YPP24EAKDV

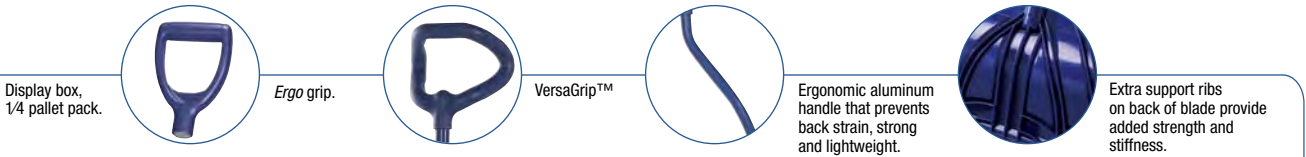

KEY	PRODUCT NUMBER	CATALOG NUMBER	QUALITY	PKG.	PALLET PACK	UNIT WEIGHT LB. (KG)	APPROX. NET VOL./UN CU. FT. (CU. M)	HANDLE OR D-GRIP	HANDLE LENGTH IN. (CM)	BLADE DIMENSIONS IN. (CM)	APPROX. TOT. LENGTH IN. (CM)	REPL. HANDLE	DESCRIPTION
E	YPP21EAKD	99463	YUKON ERGO	6	90	4.5 (2.04)	0.648 (0.0137)	POLY ERGO	48 (121.9)	11 × 20 3/4 (27.9 × 52.7)	56 1/4 (142.8)	–	Snow pusher, blue poly blade, ergonomic lightweight aluminum handle.
F	YP21EAKDVS	99078	YUKON ERGO	6	72	3.145 (1.43)	0.648 (0.0137)	POLY VERSA-GRIP™	48 1/4 (122.6)	11 × 20 3/4 (27.9 × 52.7)	55 1/2 (140.9)	–	Snow pusher, blue poly blade, ergonomic lightweight aluminum handle, VersaGrip™.
G	YPP24SAKD	78522	YUKON ERGO	6	72	4.73 (2.14)	0.833 (0.0236)	POLY ERGO	46 3/4 (118.7)	11 3/4 × 24 (29.8 × 60.9)	57 1/4 (145.4)	–	Snow pusher, blue poly blade, straight lightweight aluminum handle.
–	YPP24SAKDV	785227	YUKON ERGO	10	40	4.73 (2.14)	–	POLY ERGO	46 3/4 (118.7)	11 3/4 × 24 (29.8 × 60.9)	57 1/4 (145.4)	–	Same as YPP24SAKD, but delivered in a display box.
H	YPP24EAKD	78523	YUKON ERGO	6	48	3.98 (1.80)	0.833 (0.0236)	POLY ERGO	47 3/4 (121.2)	11 3/4 × 24 (29.8 × 60.9)	58 1/2 (148.6)	–	Snow pusher, blue poly blade, ergonomic lightweight aluminum handle.
–	YPP24EAKDV	785237	YUKON ERGO	10	40	3.98 (1.80)	–	POLY ERGO	47 3/4 (121.2)	11 3/4 × 24 (29.8 × 60.9)	58 1/2 (148.6)	–	Same as YPP24EAKD, but delivered in a display box.



POLY SNOW SHOVELS & PUSHERS



KEY	PRODUCT NUMBER	CATALOG NUMBER	QUALITY	PKG.	PALLET PACK	UNIT WEIGHT LB. (KG)	APPROX. NET. VOL./UN CU. FT. (CU. M)	HANDLE OR D-GRIP	HANDLE LENGTH IN. (CM)	BLADE DIMENSIONS IN. (CM)	APPROX. TOT. LENGTH IN. (CM)	REPL. HANDLE	DESCRIPTION
A	YPP24KL	78462	YUKON	6	72	4.00 (1.81)	0.833 (0.0236)	LONG	48 (121.9)	11 3/4 × 24 (29.8 × 60.9)	58 3/4 (149.2)	-	Snow pusher, blue poly blade, varnished ash handle.
B	YPM18FKD	80659	YUKON	6	90	4.20 (1.90)	0.648 (0.0183)	POLY POWER D	41 1/2 (105.4)	13 1/2 × 18 (34.3 × 45.7)	50 1/2 (128.3)	-	Snow Mountain Mover, blue poly blade, fiberglass handle.
C	YPM18FKDR	78463	YUKON	6	90	4.80 (2.17)	0.648 (0.0183)	POLY POWER D	41 1/2 (105.4)	13 1/2 × 18 (34.3 × 45.7)	50 1/2 (128.3)	-	Snow Mountain Mover, blue poly blade with steel wear strip, fiberglass handle.

Winter just got easier.

POLYPROPYLENE SHOVELS & PUSHERS



KEY	PRODUCT NUMBER	CATALOG NUMBER	QUALITY	PKG.	PALLET PACK	UNIT WEIGHT LB. (KG)	APPROX. NET. VOL./UN CU. FT. (CU. M)	HANDLE OR D-GRIP	HANDLE LENGTH IN. (CM)	BLADE DIMENSIONS IN. (CM)	APPROX. TOT. LENGTH IN. (CM)	REPL. HANDLE	DESCRIPTION
A	GIP139KD	81759	GRIZZLY	6	72	2.80 (1.27)	1.066 (0.0322)	POLY POWER D	42 (106.7)	13 7/8 × 16 3/8 (35.2 × 42.6)	53 1/2 (135.89)	03046KPD*	Grizzly all-purpose shovel, grey polypropylene blade, satined ash handle.
B	GIPM18KD	99068	GRIZZLY	6	90	3.1 (1.41)	0.648 (0.0137)	POLY POWER D	42 (106.7)	13 1/2 × 18 (34.3 × 45.7)	51 1/2 (130.81)	03046KPD*	Grizzly all-purpose mountain mover, grey polypropylene blade, satined ash handle.
C	GIPP21KD	81760	GRIZZLY	6	90	2.90 (1.31)	1.843 (0.0522)	POLY POWER D	48 (121.9)	11 × 20 3/4 (27.9 × 52.7)	56 3/4 (144.15)	03046KPD*	Grizzly all-purpose pusher, grey polypropylene blade, satined ash handle.
D	GIPP26KD	81770	GRIZZLY	6	72	3.05 (1.38)	2.268 (0.0642)	POLY POWER D	48 (121.9)	11 × 26 (27.9 × 66.0)	56 3/4 (144.15)	03046KPD*	Grizzly all-purpose pusher, grey polypropylene blade, satined ash handle.

* These handles can fit onto the models above but differ from the originals.



POLY SNOW SLEIGH SHOVELS



Ergonomic handle
For heavy snowfalls, no tool is faster or easier to use than a Yukon ergo snow sleigh shovel.

For EPSS24:
display box that holds
6 sleigh shovels.



Epoxy coated steel handle have the strength to move large volumes of snow.

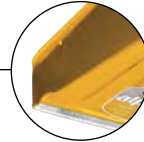

Steel wear strip extends blade life.

KEY	PRODUCT NUMBER	CATALOG NUMBER	QUALITY	PKG.	PALLET PACK	CAPACITY CU. FT (CU. M)	UNIT WEIGHT LB. (KG)	APPROX. NET VOL./UN CU. FT. (CU. M)	HANDLE	HANDLE LENGTH IN. (CM)	BLADE DIMENSIONS IN. (CM)	APPROX. TOT. LENGTH IN. (CM)	REPL. HANDLE	DESCRIPTION
A	NPSS18	81661	NORDIC	3	42	1.6 (0.045)	10 (4.55)	1.428 (0.0405)	STEEL	54.5 (138.4)	19 1/4 × 23 (48.9 × 58.4)	58 (147.3)	HENPSS18	Small sleigh shovel, dark orange poly scoop, steel wear strip and steel handle with grey baked enamel finish.
B	APSS22	81662	ALPINE	3	48	3 (0.085)	10.50 (4.76)	1.648 (0.0467)	STEEL	56 (142.2)	23 1/2 × 27 3/4 (48.9 × 58.4)	62 (157.5)	HEAPSS22	Sleigh shovel, yellow poly scoop, steel wear strip and steel handle with grey baked enamel finish.
C	EPSS24	78051	YUKON ERGO	6	24	3.8 (0.108)	10.75 (4.87)	2.270 (0.0642)	STEEL	42 1/2 (108.0)	23 1/2 × 30 1/2 (59.7 × 77.5)	61 (154.09)	HEEPSS24	Ergo sleigh shovel, blue poly scoop, steel wear strip and ergonomic steel handle with grey baked enamel finish. Delivered in a display box.
D	YPSS26	81665	YUKON ERGO	3	42	4.3 (0.122)	14.10 (6.40)	2.229 (0.0631)	STEEL	54 (137.2)	27 1/2 × 31 (69.9 × 78.7)	61 (154.9)	HEYPSS26	Ergo sleigh shovel, blue poly scoop, steel wear strip and ergonomic steel handle with grey baked enamel finish.



ROOF RAKE



● GPRR24

Roof rake

- Ideal for removing snow from roofs, awnings and tarps.
- Lightweight aluminum handle extends to 16' (5 m).
- Lightweight poly blade won't damage roof.

KEY	PRODUCT NUMBER	CATALOG NUMBER	QUALITY	PKG.	PALLET PACK	UNIT WEIGHT LB. (KG)	APPROX. NET VOL./UN CU. FT. (CU. M)	BLADE DIMENSIONS IN. (CM)	APPROX. TOT. LENGTH IN. (CM)	REPL. HANDLE	DESCRIPTION
A	GPRR24	80152	GARANT	1	72	4.18 (1.90)	0.926 (0.0262)	24 × 6 × 1 7/8 (61.0 × 15.2 × 4.6)	16' 3 3/8" (5.0 M)	GPRR24E	Snow roof rake, blue poly blade, painted aluminum handle, 3 sections of 60" (152.4 cm). DELIVERED UNASSEMBL.



4-WAY POLY SNOW SHOVEL

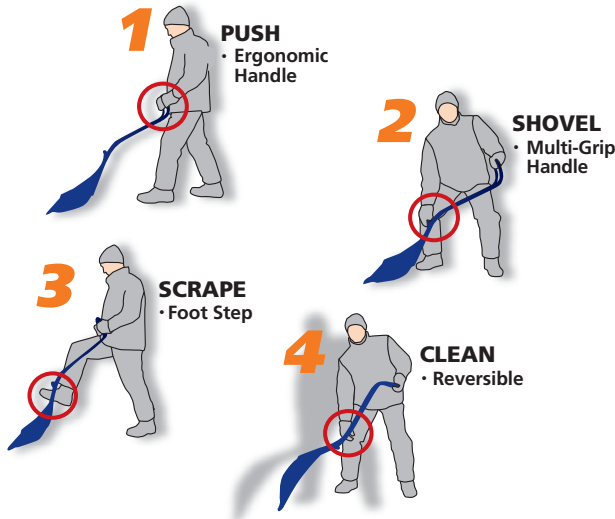

KEY	PRODUCT NUMBER	CATALOG NUMBER	QUALITY	PKG.	PALLET PACK	CAPACITY CU. FT. (CU. M)	UNIT WEIGHT LB. (KG)	APPROX. NET VOL./UN CU. FT. (CU. M)	HANDLE OR D-GRIP	HANDLE LENGTH IN. (CM)	BLADE DIMENSIONS IN. (CM)	APPROX. TOT. LENGTH IN. (CM)	REPL. HANDLE	DESCRIPTION
A	YEPG424	99795	GARANT	6	36	1.9 (0.0538)	5.7 (2.58)	6.37 (0.1805)	ALU-MINUM	43.86 (111.4)	25.75 × 34.5 (67.4 × 87.63)	56.28 (143)	-	4-way shovel: push with the one piece ergonomic lightweight aluminum handle, shovel with the multi-grips, scrape with the foot step and the steel wear strip and reversible to clean tight areas and spaces! 24" blue poly scoop. Work comfortably and efficiently. Secondary display base that can hold six G4 shovels included.



POLY SNOW SHOVELS & PUSHERS



A AP139KDR

B APM18KDR

C APM18KDRVS

D APW18KDR

E APP21KDR
APP21KDRV
APP21KDRY
APP26KDR

Display box,
1/4 pallet pack.



Artic Blast
grip.



VersaGrip™

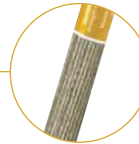

Ash handle, strong
and moisture resistant.

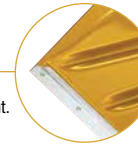

Steel wear strip
extends blade life.

KEY	PRODUCT NUMBER	CATALOG NUMBER	QUALITY	PKG.	PALLET PACK	UNIT WEIGHT LB. (KG)	APPROX. NET. VOL./UN CU. FT. (CU. M)	HANDLE OR D-GRIP	HANDLE LENGTH IN. (CM)	BLADE DIMENSIONS IN. (CM)	APPROX. TOT. LENGTH IN. (CM)	REPL. HANDLE	DESCRIPTION
A	AP139KDR	80608	ALPINE	6	72	3.19 (1.45)	0.592 (0.0167)	POLY ARTIC BLAST	40 1/4 (102.2)	13 7/8 × 16 3/4 (35.2 × 42.6)	52 (132.1)	03046KPD	Snow shovel, yellow poly blade with a steel wear strip, stained ash handle.
B	APM18KDR	80609	ALPINE	6	90	3.77 (1.71)	0.648 (0.0183)	POLY ARTIC BLAST	42 1/4 (107.3)	13 1/2 × 18 (34.3 × 45.7)	50 (127.0)	03046KPD	Mountain Mover, yellow poly blade with a steel wear strip, stained ash handle.
C	APM18KDRVS	99326	ALPINE	6	72	4.875 (2.21)	0.648 (0.0137)	POLY VERSA-GRIP™	42 1/2 (108)	13 1/2 × 18 (34.3 × 45.7)	52 (132.1)	—	Snow Mountain Mover, yellow poly blade with a steel wear strip, stained ash handle, VersaGrip™.
D	APW18KDR	80610	ALPINE	8	120	3.22 (1.46)	0.396 (0.0112)	POLY ARTIC BLAST	42 1/4 (107.3)	17 3/4 × 13 1/4 (45.1 × 33.7)	49 1/2 (125.7)	03046KPD	Wide snow shovel, yellow poly blade with a steel wear strip, stained ash handle.
E	APP21KDR	80611	ALPINE	6	90	3.63 (1.65)	0.648 (0.0137)	POLY ARTIC BLAST	46 1/4 (117.5)	11 × 20 3/4 (27.9 × 52.7)	54 1/2 (138.4)	03046KPD	Snow pusher, yellow poly blade with a steel wear strip, stained ash handle.
—	APP21KDRV	806117	ALPINE	20	80	3.63 (1.65)	0.670 (0.0189)	POLY ARTIC BLAST	46 1/4 (117.5)	11 × 20 3/4 (27.9 × 52.7)	54 1/2 (138.4)	03046KPD	Same as APP21KDR, but delivered in a display box.
—	APP21KDRY	806119	ALPINE	60	60	3.63 (1.65)	0.700 (0.0198)	POLY ARTIC BLAST	46 1/4 (117.5)	11 × 20 3/4 (27.9 × 52.7)	54 1/2 (138.4)	03046KPD	Same as APP21KDR, but delivered in a bulk packaging.
—	APP26KDR	80612	ALPINE	6	72	3.70 (1.68)	0.833 (0.0235)	POLY ARTIC BLAST	46 1/4 (117.5)	11 × 26 (27.9 × 66.0)	54 1/2 (138.4)	03046KPD	Snow pusher, yellow poly blade with a steel wear strip, stained ash handle.

POLY SNOW SHOVELS & PUSHERS



A NP091KD

B NP139KD
NP139KDY
NP139KDV

C NP139KL

D NPM18KD
NPM18KDY
NPM18KDV

E NPM18KDVS

Display box,
1/4 pallet pack.



Ribbed grip.



VersaGrip™

KEY	PRODUCT NUMBER	CATALOG NUMBER	QUALITY	PKG.	PALLET PACK	UNIT WEIGHT LB. (KG)	APPROX. NET. VOL./UN CU. FT. (CU. M)	HANDLE OR D-GRIP	HANDLE LENGTH IN. (CM)	BLADE DIMENSIONS IN. (CM)	APPROX. TOT. LENGTH IN. (CM)	REPL. HANDLE	DESCRIPTION
A	NP091KD	80594	NORDIC	10	150	1.46 (0.66)	0.388 (0.0676)	POLY RIBBÉE	28 1/4 (71.8)	9 1/8 × 12 5/8 (23.2 × 32.1)	36 3/4 (93.3)	–	Car shovel, dark orange poly blade, stained ash handle.
B	NP139KD	80596	NORDIC	6	72	2.66 (1.21)	0.592 (0.0167)	POLY RIBBÉE	40 1/4 (102.2)	13 7/8 × 16 3/4 (35.2 × 42.5)	52 (132.1)	03046KPD	Snow shovel, dark orange poly blade, stained ash handle.
–	NP139KDY	805969	NORDIC	90	90	2.66 (1.21)	–	POLY RIBBÉE	40 1/4 (102.2)	13 7/8 × 16 3/4 (35.2 × 42.5)	52 (132.1)	03046KPD	Same as NP139KD, but delivered in a bulk packaging.
–	NP139KDV	805967	NORDIC	20	80	2.66 (1.21)	0.580 (0.0164)	POLY RIBBÉE	40 1/4 (102.2)	13 7/8 × 16 3/4 (35.2 × 42.5)	52 (132.1)	03046KPD	Same as NP139KD, but delivered in a display box.
C	NP139KL	78043	NORDIC	6	72	3.09 (1.40)	0.592 (0.0167)	LONG	49 (124.5)	13 7/8 × 16 3/4 (35.2 × 42.5)	59 1/4 (150.5)	–	Snow shovel, dark orange poly blade, stained ash handle.
D	NPM18KD	80598	NORDIC	6	90	3.36 (1.52)	0.648 (0.0137)	POLY RIBBÉE	36 (91.4)	13 1/2 × 18 (34.3 × 45.7)	42 1/4 (107.3)	03046KPD	Mountain Mover, dark orange poly blade, stained ash handle.
–	NPM18KDY	805989	NORDIC	60	60	3.36 (1.52)	–	POLY RIBBÉE	36 (91.4)	13 1/2 × 18 (34.3 × 45.7)	42 1/4 (107.3)	03046KPD	Same as NPM18KD, but delivered in a bulk packaging.
–	NPM18KDV	805987	NORDIC	20	80	3.36 (1.52)	0.580 (0.0164)	POLY RIBBÉE	36 (91.4)	13 1/2 × 18 (34.3 × 45.7)	42 1/4 (107.3)	03046KPD	Same as NPM18KD, but delivered in a display box.
E	NPM18KDVS	99067	NORDIC	6	72	3.63 (1.64)	0.648 (0.0137)	POLY VERSA-GRIP™	42 1/2 (108)	13 1/2 × 18 (34.3 × 45.7)	52 3/4 (137.7)	–	Snow Mountain Mover, dark orange poly blade, stained ash handle, VersaGrip™.



POLY SNOW SHOVELS & PUSHERS



F NPW18KD

G NPP21KD
NPP21KDY
NPP21KDV

H NPP21KDVS
NPP26KDVS

I NPP26KD
NPP26KDY

Display box,
1/4 pallet pack.



Ribbed grip.



VersaGrip™

KEY	PRODUCT NUMBER	CATALOG NUMBER	QUALITY	PKG.	PALLET PACK	UNIT WEIGHT LB. (KG)	APPROX. NET. VOL./UN CU. FT. (CU. M)	HANDLE OR D-GRIP	HANDLE LENGTH IN. (CM)	BLADE DIMENSIONS IN. (CM)	APPROX. TOT. LENGTH IN. (CM)	REPL. HANDLE	DESCRIPTION
F	NPW18KD	80600	NORDIC	8	120	3.13 (1.4)	0.396 (0.0112)	POLY RIBBÉE	36 (91.4)	17 3/4 × 13 1/4 (45.1 × 33.7)	42 1/4 (107.3)	03046KPD	Wide snow shovel, dark orange poly blade, stained ash handle.
G	NPP21KD	80602	NORDIC	6	90	2.88 (1.31)	0.648 (0.0137)	POLY RIBBÉE	46 1/4 (117.5)	11 × 20 3/4 (27.9 × 52.7)	54 1/2 (138.4)	03046KPD	Snow pusher, dark orange poly blade, stained ash handle.
-	NPP21KDY	806029	NORDIC	60	60	2.88 (1.31)	-	POLY RIBBÉE	46 1/4 (117.5)	11 × 20 3/4 (27.9 × 52.7)	54 1/2 (138.4)	03046KPD	Same as NPP21KD, but delivered in a bulk packaging.
-	NPP21KDV	806027	NORDIC	20	80	2.88 (1.31)	0.670 (0.0189)	POLY RIBBÉE	46 1/4 (117.5)	11 × 20 3/4 (27.9 × 52.7)	54 1/2 (138.4)	03046KPD	Same as NPP21KD, but delivered in a display box.
H	NPP21KDVS	99455	NORDIC	6	72	4.75 (2.15)	0.833 (0.0236)	POLY VERSA-GRIP™	48 1/4 (122.6)	11 × 20 3/4 (27.9 × 52.7)	57 (144.8)	-	Snow pusher, dark orange poly blade, stained ash handle, VersaGrip™.
-	NPP26KDVS	99456	NORDIC	4	60	5.8 (2.63)	1.240 (0.0351)	POLY VERSA-GRIP™	48 1/4 (122.6)	11 × 26 (27.9 × 66)	57 (144.8)	-	Snow pusher, dark orange poly blade, stained ash handle, VersaGrip™.
I	NPP26KD	80604	NORDIC	6	72	3.48 (1.58)	0.833 (0.0235)	POLY RIBBÉE	46 1/4 (117.5)	11 × 26 (27.9 × 66)	54 1/2 (138.4)	03046KPD	Snow pusher, dark orange poly blade, stained ash handle.
-	NPP26KDY	806049	NORDIC	48	48	3.48 (1.58)	-	POLY RIBBÉE	46 1/4 (117.5)	11 × 26 (27.9 × 66)	54 1/2 (138.4)	03046KPD	Same as NPP26KD, but delivered in a bulk packaging.

Lawn Rakes and Rakes

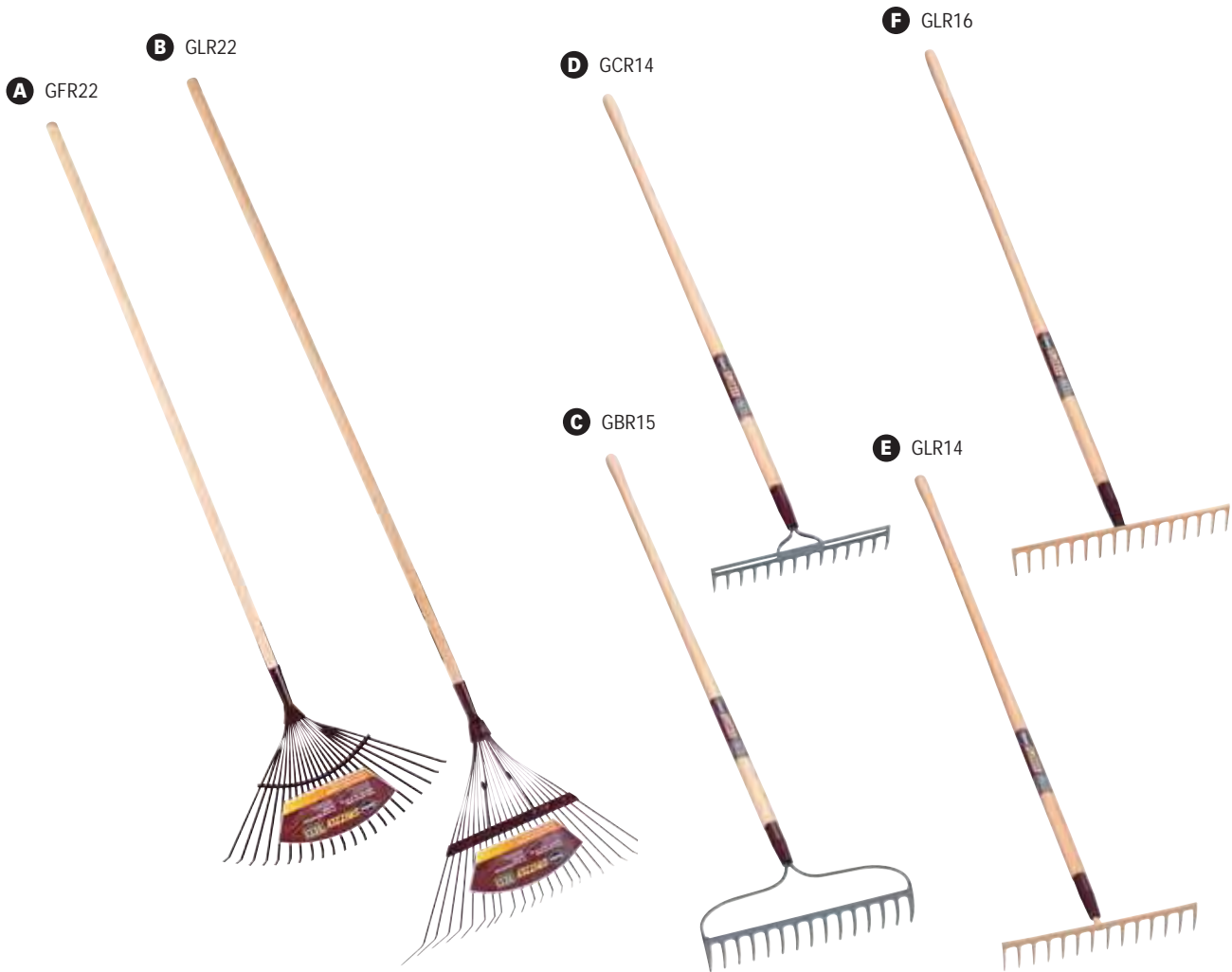

KEY	PRODUCT NUMBER	CATALOG NUMBER	QUALITY	PKG.	PALLET PACK	UNIT WEIGHT LB. (KG)	APPROX. NET VOL./UN CU. FT. (CU.M)	HANDLE LENGTH IN. (CM)	TINES	BLADE DIMENSIONS IN. (CM)	APPROX. TOT. LENGTH IN. (CM)	REPL. HANDLE	DESCRIPTION
A	GFR22	81723	Grizzly	12	192	1.70 (0.77)	0.121 (0.0034)	54 (137.2)	22	20 (50.8)	68 (172.7)	C2565409	Fan rake, tempered steel tines, premium ash handle.
B	GLR22	81184	Grizzly	6	96	2.50 (1.13)	0.361 (0.0102)	54 (137.2)	22	24 (61.0)	71 1/2 (181.6)	C2565409	Industrial grade springback lawn rake, tempered steel tines, reinforced socket with welded plate, premium ash handle.
C	GBR15	80745	Grizzly	6	240	3.60 (1.63)	0.279 (0.0079)	60 (152.4)	15	16 (40.6)	65 3/4 (167.0)	C2516009	Heavy-duty bow rake, steel head, premium ash handle.
D	GCR14	80747	Grizzly	6	216	3.00 (1.36)	0.316 (0.0089)	60 (152.4)	14	13 3/4 (34.9)	62 (157.5)	C2516009	Heavy-duty double back level rake, steel head, premium ash handle.
E	GLR14	80751	Grizzly	6	360	3.00 (1.36)	0.185 (0.0052)	60 (152.4)	14	14 3/4 (37.5)	61 (154.9)	C2516009	Level head rake, gold baked enamel head finish, premium ash handle.
F	GLR16	80752	Grizzly	6	360	3.00 (1.36)	0.199 (0.0056)	66 (167.6)	16	16 5/8 (42.2)	66 3/4 (169.5)	C2516009	Level head rake, gold baked enamel head finish, premium ash handle.



KEY	PRODUCT NUMBER	CATALOG NUMBER	QUALITY	PKG.	PALLET PACK	UNIT WEIGHT LB. (KG)	APPROX. NET VOL./UN CU. FT. (CU.M)	HANDLE LENGTH IN. (CM)	TINES	BLADE DIMENSIONS IN. (CM)	APPROX. TOT. LENGTH IN. (CM)	REPL. HANDLE	DESCRIPTION
G	GAR14	80744	Grizzly	3	144	6.10 (2.77)	0.940 (0.0266)	60 (152.4)	14	15 5/8 (39.7)	76 1/2 (194.3)	C2526009	Steel asphalt rake, gold baked enamel head finish, 18" (45.7 cm) steel shank securely welded to the head, premium ash handle.
H	GRR14	80755	Grizzly	3	144	5.20 (2.36)	0.495 (0.0140)	72 (182.9)	14	15 5/8 (39.7)	72 3/4 (184.8)	C2526009	Steel road rake for heavy work, gold baked enamel head finish, premium ash handle.
I	EAAL36	78168	Grizzly	1	72	5.00 (2.26)	0.490 (0.0139)	82 (208.3)	36	36 (91.4)	92 (233.7)	86961	Asphalt rake, anodized aluminum handle, aluminum head and braces. Delivered unassembled.
J	GALR36	80841	Grizzly	1	72	5.50 (2.50)	0.558 (0.0159)	66 (167.6)	36	36 (91.4)	66 (167.6)	-	Landscaping level rake, anodized aluminum handle, aluminum head and braces. Delivered unassembled.

Surfa • Slick

Magnesium Asphalt Lutes

Surfa Slick magnesium asphalt lutes are lightweight, rugged and will provide a finish your customers will appreciate. Our asphalt lutes have the strength and spring of steel and yet are one third lighter than aluminum. The bar is joined to the handle with a heavy duty casting that creates a rigid connection superior to weaker braced connections. The lute bar's serrated edge is formed with slightly blunted points and rounded notches to permit material to pass through without jamming. Bars are available in three formats and poles are available in lengths ranging 6' to 8'4" :

Magnesium Asphalt Lutes

Magnesium Handles	LENGTH/FT.	MODEL NO.	BAR	POLE	APPROX. WT. LBS.
Our most popular model	6	246	24"	1-1/2" x 6'	3.2
		306	30"	1-1/2" x 6'	3.4
		366	36"	1-1/2" x 6'	3.6
		426	42"	1-1/2" x 6'	3.8
		486	48"	1-1/2" x 6'	4.1
	7	247	24"	1-1/4" x 6'9"	3.6
		307	30"	1-1/4" x 6'9"	3.8
		367	36"	1-1/4" x 6'9"	4.0
		427	42"	1-1/4" x 6'9"	4.2
		487	48"	1-1/4" x 6'9"	4.5

Magnesium Asphalt Parts

Model no.	Description	Model no.	Description
650L	1 1/2"x6' Pole with safety tip	24LS	24" Bar serrated one side
725L	1 1/4"x6'9" Pole with safety tip	30LS	30" Bar serrated one side
840L	1 1/2"x8'4" Pole with safety tip	36LS	36" Bar serrated one side
125ST	1 1/4" Safety tip	150ST	1 1/2" Safety tip
125LH	1 1/4" Lute bar holder set	150LH	1 1/2" Lute bar holder set

Hoes



KEY	PRODUCT NUMBER	CATALOG NUMBER	QUALITY	PKG.	PALLET PACK	UNIT WEIGHT LB. (KG)	APPROX. NET VOL./UN CU. FT. (CU.M)	HANDLE OR "D" GRIP	HANDLE LENGTH IN. (CM)	BLADE DIMENSIONS IN. (CM)	APPROX. TOT. LENGTH IN. (CM)	REPL. HANDLE	DESCRIPTION
A	GMH10	80722	Grizzly	3	72	4.30 (1.95)	0.539 (0.0153)	Long	66 (167.6)	10 x 6 (25.4 x 15.2)	69 (175.3)	C3526609	Mortar hoe , shank type, gold baked enamel head finish, premium ash handle.
B	GMH07	80721	Grizzly	3	216	2.42 (1.10)	0.131 (0.0037)	Long	54 (137.2)	7 x 4 3/4 (17.8 x 12.1)	57 1/4 (145.4)	C2515409	Forged mason/plasterer hoe , shank type, gold baked enamel head finish, premium ash handle.
C	GGH65	80716	Grizzly	3	144	2.30 (1.04)	0.243 (0.0069)	Long	54 (137.2)	6 1/2 x 4 3/4 (16.5 x 12.1)	57 1/2 (146.1)	C2515409	Garden hoe , shank type, steel head, premium ash handle.
D	GGH8	80718	Grizzly	3	144	2.40 (1.09)	0.252 (0.0071)	Long	54 (137.2)	8 x 4 3/8 (20.3 x 11.1)	57 1/2 (146.1)	C2515409	Garden hoe , shank type, steel head, premium ash handle.
E	GBH65	80710	Grizzly	3	120	2.02 (0.92)	0.199 (0.0056)	Long	54 (137.2)	6 1/2 x 2 (16.5 x 5.1)	58 (147.3)	C2515409	Beet hoe , shank type, steel head, replaceable tempered steel blade, premium ash handle.
F	GAAH6	80848	Grizzly	3	72	2.09 (0.95)	0.317 (0.0090)	Long	54 (137.2)	6 x 1 1/16 (15.2 x 2.7)	57 3/4 (146.7)	-	Action hoe , sharp double-edge cultivator, weeder and edging tool, premium ash handle.
G	GH348	80798	Grizzly	3	144	2.34 (1.06)	0.336 (0.0095)	Long	48 (121.9)	9 x 3 1/2 (22.8 x 8.9)	48 1/2 (123.2)	C2515409	Cultivator combined with a 3 1/2" (8.9 cm) hoe, premium ash handle.



Digger, Weed Cutters, Cultivator and Scoop



KEY	PRODUCT NUMBER	CATALOG NUMBER	QUALITY	PKG.	PALLET PACK	UNIT WEIGHT LB. (KG)	APPROX. NET VOL./UN CU. FT. (CU.M)	HANDLE OR "D" GRIP	HANDLE LENGTH IN. (CM)	BLADE DIMENSIONS IN. (CM)	APPROX. TOT. LENGTH IN. (CM)	REPL. HANDLE	DESCRIPTION
H	GPHDU	80350	Grizzly	1	164	15.90 (7.21)	1.664 (0.0471)	Long	58 (147.3)	-	70 3/4 (179.7)	C5604	Heavy-duty universal post hole digger. Digging blade size: 7" x 7 1/2" (17.8 cm x 19.1 cm), hardwood handle.
I	GWC14	80839	Grizzly	2	72	2.43 (1.10)	0.557 (0.0158)	Long	30 3/4 (78.1)	2 5/8 x 14 1/4 (6.7 x 36.2)	37 3/4 (95.9)	-	Weed cutter, steel serrated blade securely attached to a metal bow, shaped premium ash handle.
J	GWC09	80838	Grizzly	3	570	1.31 (0.59)	0.046 (0.0013)	Short	8 (20.3)	2 x 8 1/2 (5.1 x 21.6)	42 (106.7)	-	Grass whip, steel serrated blade securely attached to a metal shaft, shaped hardwood handle.
K	GC348	80792	Grizzly	3	120	1.93 (0.88)	0.194 (0.0055)	Long	48 (121.9)	4 1/4 (10.8)	55 1/2 (141.0)	C2565409	Adjustable cultivator, 3 forged steel prongs, premium ash handle.
L	E432SG	78167	Grizzly	2	120	4.85 (2.20)	-	Long	32 (81.2)	14 (35.6)	32 (81.2)	B7173201SG	Muck scoop, steel blade, premium varnished ash handle with safety grip.

Forged Steel Forks and Sod Lifter



KEY	PRODUCT NUMBER	CATALOG NUMBER	QUALITY	PKG.	PALLET PACK	UNIT WEIGHT LB. (KG)	APPROX. NET VOL./UN CU. FT. (CU.M)	HANDLE OR "D" GRIP	HANDLE LENGTH IN. (CM)	BLADE DIMENSIONS IN. (CM)	APPROX. TOT. LENGTH IN. (CM)	REPL. HANDLE	DESCRIPTION
A	G411D	81095	Grizzly	3	216	4.60 (2.09)	0.231 (0.0065)	Steel	32 3/4 (83.2)	7 1/2 x 11 (19.1 x 27.9)	44 1/2 (113.0)	C1563309	Spading fork, one-piece forged and tempered steel head, gold baked finish, premium ash handle. 4 tines.
B	G411L	81110	Grizzly	3	216	4.40 (2.00)	0.278 (0.0079)	Long	48 (121.9)	7 1/2 x 11 (19.1 x 27.9)	59 1/2 (151.1)	C1514809	Spading fork, one-piece forged and tempered steel head, gold baked finish, premium ash handle. 4 tines.
C	GFSL9D	80857	Grizzly	1	-	4.40 (2.00)	1.360 (0.0385)	Steel	31 1/2 (80.0)	9 x 5 (22.9 x 12.7)	51 3/4 (131.4)	C1563309	Sod lifter, forged and tempered steel blade, gold baked finish, premium ash handle.



Forged Steel Hoes



KEY	PRODUCT NUMBER	CATALOG NUMBER	QUALITY	PKG.	PALLET PACK	UNIT WEIGHT LB. (KG)	APPROX. NET VOL./UN CU. FT. (CU.M)	HANDLE OR "D" GRIP	HANDLE LENGTH IN. (CM)	BLADE DIMENSIONS IN. (CM)	APPROX. TOT. LENGTH IN. (CM)	REPL. HANDLE	DESCRIPTION
A	GIH6	80720	Grizzly	2	72	3.20 (1.45)	0.440 (0.0125)	Long	54 (137.2)	5 7/8 x 7 3/8 (14.9 x 18.7)	54 (137.2)	C3565409	Forged Italian hoe, premium ash handle.
B	GFBH7S	80713	Grizzly	3	150	2.14 (0.97)	0.239 (0.0068)	Long	54 (137.2)	7 x 3 1/2 (17.8 x 8.9)	59 1/8 (150.2)	C2505409	Forged beet hoe, socket type, gold baked head finish, premium ash handle.
C	GHH4	80739	Grizzly	3	150	2.10 (0.95)	0.163 (0.0046)	Long	48 (121.9)	8 x 5 (20.3 x 12.7)	56 1/4 (142.8)	C2515409	Dutch hoe (Oshawa pattern), shank type, gold baked head finish, premium ash handle.
D	GFWH7	80715	Grizzly	3	120	2.15 (0.98)	0.199 (0.0056)	Long	54 (137.2)	4 3/4 x 6 1/8 (12.1 x 15.6)	57 1/2 (146.1)	C2515409	Forged Warren hoe, shank type, gold baked head finish, premium ash handle.



Specialty Forks



KEY	PRODUCT NUMBER	CATALOG NUMBER	QUALITY	PALLET PKG.	UNIT WEIGHT LB. (KG)	APPROX. NET VOL./UN CU. FT. (CU.M)	HANDLE OR "D" GRIP	HANDLE LENGTH IN. (CM)	HEAD DIMENSIONS IN. (CM)	APPROX. TOT. LENGTH IN. (CM)	REPL. HANDLE	DESCRIPTION	
A	G031248	81064	Grizzly	3	216	2.80 (1.27)	0.285 (0.0081)	Long	48 (121.9)	12 (30.5)	60 (152.4)	C1504809	Hay forks, one-piece forged and tempered steel heads, gold baked finish, premium ash handles, 3 tines.
	G031254	81069	Grizzly	3	216	2.90 (1.32)	0.307 (0.0087)	Long	54 (137.2)	12 (30.5)	66 (167.6)	C1505409	
B	G031448	81070	Grizzly	3	216	3.00 (1.36)	0.285 (0.0081)	Long	48 (121.9)	14 (35.6)	61 1/2 (156.2)	C1504809	Straw fork, one-piece forged and tempered steel head, gold baked finish, premium ash handle, 3 tines.
C	G1013L	81727	Grizzly	3	150	4.00 (1.81)	0.296 (0.0084)	Long	48 (121.9)	10 1/2 (26.7)	60 1/4 (153.0)	C1514809	Bedding fork, ten tempered steel and welded tines, 13" (33.0 cm) long, clear coat finish, premium ash handle.
D	GP1610L	81713	Grizzly	3	72	1.20 (0.54)	0.391 (0.0111)	Long	52 (132.1)	14 1/2 (36.8)	60 1/2 (153.7)	C1525209	Bedding fork, one-piece black nylon head, sixteen 10" (25.4 cm) tines, hardwood handle.
E	G0415D	81133	Grizzly	3	144	3.98 (1.81)	0.630 (0.0178)	Poly	30 1/4 (76.8)	15 (38.1)	44 1/2 (113.0)	C1563309	Mushroom fork, one-piece forged and tempered steel head, gold baked finish, four 15" (38.1 cm) tines, premium ash handle, "D" grip with cushioned grip.
F	G0816D	81087	Grizzly	1	60	6.10 (2.77)	0.630 (0.0178)	Steel	32 3/4 (83.2)	13 1/4 (33.7)	48 1/2 (123.2)	C1543309	Ensilage fork, one-piece forged and tempered steel head, gold baked finish, eight 16" (40.6 cm) tines, premium ash handle.
G	G1016D	81114	Grizzly	1	-	6.59 (2.99)	0.723 (0.0205)	Acier	32 3/4 (83.2)	15 1/2 (39.4)	48 1/2 (123.2)	C1543309	Ensilage fork, one-piece forged and tempered steel head, gold baked finish, ten 16" (40.6 cm) tines, premium ash handle.



Manure and Barn Forks

A G0413D

B G0413L

C G0513D

D G0513L

E G0613D

F G0613L

G G0516D

H G0516L



KEY	PRODUCT NUMBER	CATALOG NUMBER	QUALITY	PALLET PKG.	UNIT PACK	UNIT WEIGHT LB. (KG)	APPROX. NET VOL./UN CU. FT. (CU.M)	HANDLE OR "D" GRIP	HANDLE LENGTH IN. (CM)	BLADE DIMENSIONS IN. (CM)	APPROX. TOT. LENGTH IN. (CM)	REPL. HANDLE	DESCRIPTION
A	G0413D	81071	Grizzly	3	168	3.50 (1.59)	0.263 (0.0074)	Steel	32 3/4 (83.2)	9 1/4 (25.5)	45 3/4 (116.2)	C1563309	Manure fork , one-piece forged and tempered steel head, gold baked finish, premium ash handle, four 13" (33.0 cm) tines.
B	G0413L	81072	Grizzly	3	192	3.50 (1.59)	0.329 (0.0093)	Long	48 (121.9)	9 1/4 (23.5)	60 3/4 (154.3)	C1514809	Manure fork , one-piece forged and tempered steel head, gold baked finish, premium ash handle, four 13" (33.0 cm) tines.
C	G0513D	81074	Grizzly	3	168	3.80 (1.72)	0.263 (0.0074)	Steel	32 3/4 (83.2)	9 3/4 (24.8)	45 3/4 (116.2)	C1563309	Manure fork , one-piece forged and tempered steel head, gold baked finish, premium ash handle, five 13" (33.0 cm) tines.
D	G0513L	81079	Grizzly	3	192	3.80 (1.72)	0.329 (0.0093)	Long	48 (121.9)	9 3/4 (24.8)	60 3/4 (154.3)	C1514809	Manure fork , one-piece forged and tempered steel head, gold baked finish, premium ash handle, five 13" (33.0 cm) tines.
E	G0613D	81084	Grizzly	3	168	4.10 (1.86)	0.263 (0.0074)	Steel	32 3/4 (83.2)	10 1/4 (26.0)	45 3/4 (116.2)	C1563309	Manure fork , one-piece forged and tempered steel head, gold baked finish, premium ash handle, six 13" (33.0 cm) tines.
F	G0613L	81086	Grizzly	3	192	4.10 (1.86)	0.329 (0.0093)	Long	48 (121.9)	10 1/4 (26.0)	60 3/4 (154.3)	C1514809	Manure fork , one-piece forged and tempered steel head, gold baked finish, premium ash handle, six 13" (33.0 cm) tines.
G	G0516D	81082	Grizzly	3	168	4.40 (2.00)	0.276 (0.0078)	Steel	32 3/4 (83.2)	12 (30.5)	48 1/2 (123.2)	C1563309	Barn fork , one-piece forged and tempered steel head, gold baked finish, premium ash handle, five 16" (40.6 cm) tines.
H	G0516L	81083	Grizzly	3	120	4.40 (2.00)	0.542 (0.0153)	Long	48 (121.9)	12 (30.5)	63 1/2 (161.3)	C1514809	Barn fork , one-piece forged and tempered steel head, gold baked finish, premium ash handle, five 16" (40.6 cm) tines.



Hooks, Hoes, and Barn Scrapers



PRODUCT KEY	CATALOG NUMBER	QUALITY	PALLET PKG.	UNIT WEIGHT LB. (KG)	APPROX. NET VOL./UN CU. FT. (CU.M)	HANDLE OR "D" GRIP	HANDLE LENGTH IN. (CM)	BLADE DIMENSIONS IN. (CM)	APPROX. TOT. LENGTH IN. (CM)	REPL. HANDLE	DESCRIPTION		
I	GH409M	81099	Grizzly	2	120	4.00 (1.81)	0.414 (0.0117)	Long	60 (152.4)	8 1/4 (20.9)	63 1/2 (161.3)	C2526009	Manure hook , one-piece forged and tempered steel head, four 9" (22.9 cm) oval tines, gold baked finish, premium ash handle.
J	GH406P	81097	Grizzly	3	144	2.30 (1.04)	0.308 (0.0087)	Long	48 (121.9)	6 (15.2)	51 1/2 (130.8)	C2515409	Potato hook , one-piece forged and tempered steel head, four 6" (15.2 cm) flattened-tip tines, gold baked finish, premium ash handle.
K	GBH12	81060	Grizzly	3	75	3.10 (1.41)	0.373 (0.0106)	Long	54 (137.2)	12 (30.5)	57 1/2 (146.1)	C2515409	Barn hoe , shank type, gold baked finish, premium ash handle.
L	GBH185	81061	Grizzly	3	120	3.50 (1.59)	0.429 (0.0129)	Long	60 (152.4)	18 1/2 (47.0)	62 (157.5)	-	Barn hoe , shank type, gold baked finish, premium ash handle.
M	GBS24D	81053	Grizzly	3	48	7.60 (3.45)	1.438 (0.0407)	Steel	48 3/4 (123.8)	24 (61.0)	54 (137.2)	-	Barn scraper , reversible steel blade, baked enamel finish, premium ash handle.
N	GBS24L	81056	Grizzly	3	48	6.90 (3.13)	1.549 (0.0439)	Long	54 (137.2)	24 (61.0)	59 1/4 (150.5)	-	Barn scraper , reversible steel blade, baked enamel finish, premium ash handle.



Hatchet, axes and splitting maul



KEY	PRODUCT NUMBER	CATALOG NUMBER	PKG.	PALLET PACK	UNIT WEIGHT LB. (KG)	APPROX. NET VOL./UN CU. FT. (CU. M)	HANDLE LENGTH IN. (CM)	HEAD WEIGHT LB. (KG)	DESCRIPTION
A	TCA12514	99183	6	450	2.10 (0.95)	0.027 (0.0008)	14 (35.6)	1.25 (0.57)	Hatchet , an essential tool for all leisure outings. Unique design for more precision and safety; overstrike protection, undetachable head and handle, integrated nail puller and non-slip ergonomic handle with curved grip. Perfect for pruning, trimming, cutting shrubs and removing nails.
B	TCA1251424	9918324	24	96	2.10 (0.95)	0.027 (0.0008)	14 (35.6)	1.25 (0.57)	Total Control 1.25 lb. hatchet display , a simple store execution for a great impact! Ideal for small surfaces. Versatile, impactful and requires minimal maintenance. Stimulates impulse buying! Includes 24 TCA12514 hatchets, header, and trays.
C	TCA22528	99184	4	216	3.98 (1.80)	0.092 (0.0026)	28 (71.1)	2.25 (1.02)	2.25 lb. all-purpose axe , perfect for all felling, delimiting and brush clearing needs. Unique design for more precision and safety; overstrike protection, undetachable head and handle, and non-slip ergonomic handle with curved grip.
D	TCA35032	99164	4	160	5.52 (2.50)	0.117 (0.0033)	32 (81.3)	3.50 (1.59)	3.5 lb. all-purpose axe , perfect for all felling, delimiting and brush clearing needs. Unique design for more precision and safety; overstrike protection, undetachable head and handle, and non-slip ergonomic handle with curved grip.
E	TCSMS60036	99185	2	144	9.23 (4.19)	0.494 (0.0140)	36 (91.4)	6.00 (2.72)	6 lb. splitting maul , ideal for splitting firewood. Unique design: longer cutting edge for a better contact surface, striking surface that can be used for splitting wood in conjunction with a splitting wedge and ramps perfectly designed to provide more splitting power and to reduce effort and fatigue.



Sledge hammers



KEY	PRODUCT NUMBER	CATALOG NUMBER	PKG.	PALLET PACK	UNIT WEIGHT LB. (KG)	APPROX. NET VOL./UN CU. FT. (CU. M)	HANDLE LENGTH IN. (CM)	HEAD WEIGHT LB. (KG)	DESCRIPTION
A	TCDEMO0836	99576	4	140	11.13 (5.05)	0.463 (0.0131)	36 (91.4)	8 (3.63)	8 lb. demolition sledge hammer , two-piece slip-eye connection for No more loose heads™, overstrike protection, durable forged steel demolition head, TPE overmold handle for better control and reduced hand fatigue, non-slip rounded and flared grip for more precision and safety, profiled handle extension.
B	TCDF1036	99577	4	144	13.25 (6.01)	0.415 (0.0012)	36 (91.4)	10 (4.54)	10 lb. sledge hammer , two-piece slip-eye connection for No more loose heads™, overstrike protection, durable forged steel heads, TPE overmold handle for better control and reduced hand fatigue, non-slip rounded and flared grip for more precision and safety, profiled handle extension.

Axes and splitting maul



KEY	PRODUCT NUMBER	CATALOG NUMBER	PKG.	PALLET PACK	UNIT WEIGHT LB. (KG)	APPROX. NET VOL./UN CU. FT. (CU. M)	HANDLE LENGTH IN. (CM)	HEAD WEIGHT LB. (KG)	REPL. HANDLE EYE US (CAN)	DESCRIPTION
A	CHS17526	81255	4	240	2.70 (1.22)	0.073 (0.0021)	26 (66.0)	1-3/4 (0.79)	B1002601SG (B7102605)*	Chainsaw axe, forged steel head, hickory handle, non-slip safety grip, American eye.
B	CAR22521	81254	4	300	3.10 (1.41)	0.069 (0.0020)	21 (53.3)	2-1/4 (1.02)	B1002101SG (B7102105)*	Professional carpenter axe, forged steel head, hickory handle, non-slip safety grip, American eye.
C	CAN22528	81252	4	320	3.30 (1.50)	0.092 (0.0026)	28 (71.1)	2-1/4 (1.02)	B1002801SG (B7102805)*	All-purpose axe, Canadian style forged steel head, hickory handle, non-slip safety grip, American eye.



KEY	PRODUCT NUMBER	CATALOG NUMBER	PKG.	PALLET PACK	UNIT WEIGHT LB. (KG)	APPROX. NET VOL./UN CU. FT. (CU. M)	HANDLE LENGTH IN. (CM)	HEAD WEIGHT LB. (KG)	REPL. HANDLE EYE US (CAN)	DESCRIPTION
A	MIC25028	81266	4	320	3.40 (1.54)	0.092 (0.0026)	28 (71.1)	2-1/2 (1.13)	B1002801SG (B7102805)*	All-purpose axe, Michigan style forged steel head, hickory handle, non-slip safety grip, American eye.
B	MIC30032	81509	4	224	4.19 (1.90)	0.106 (0.0030)	32 (81.3)	3 (1.36)	B1003201SG (B7103205)*	
C	MIC35036	81269	4	224	4.90 (2.22)	0.117 (0.0033)	36 (91.4)	3-1/2 (1.59)	B1003601SG (B7103605)*	
D	MTL25028G	78618	4	320	3.40 (1.54)	0.092 (0.0026)	28 (71.1)	2-1/2 (1.13)	B1002801SG	All purpose axe, Montréal pattern (painted/polish), premium varnished hickory handle with safety grip.
-	MTL35036G	78619	4	320	4.90 (2.22)	0.117 (0.0033)	36 (91.4)	3-1/2 (1.59)	B1003601SG	
E	GSS40036	81707	2	120	5.00 (2.27)	0.630 (0.0178)	36 (91.4)	4 (1.81)	B1093601	"Super splitter" splitting maul, forged steel head, varnished premium hickory handle. The ultimate woodsplitting tool providing more splitting

Hatchet, axes, splitting maul and sledges



KEY	PRODUCT NUMBER	CATALOG NUMBER	PKG.	PALLET PACK	UNIT WEIGHT LB. (KG)	APPROX. NET VOL./UN CU. FT. (CU. M)	HANDLE LENGTH IN. (CM)	HEAD WEIGHT LB. (KG)	REPL. HANDLE EYE US (CAN)	DESCRIPTION
A	HUN15016FG	78602	4	144	2.2 (1)	0.038 (0.0011)	16 (40.6)	1-1/2 (0.68)	-	Hunting hatchet, forged steel head, fiberglass handle, safety TPR (Thermo Plastic Rubber) grip handle.
B	CAN22528FG	78599	4	300	3.5 (1.59)	0.092 (0.0026)	28 (71.1)	2-1/4 (1.02)	HA034F	Canadian axe, forged steel head, fiberglass handle, safety TPR (Thermo Plastic Rubber) grip handle.
C	MIC35034FG	78600	4	120	5.1 (2.32)	0.073 (0.0021)	34 (86.4)	3-1/2 (1.58)	HA034F	Michigan axe, forged steel head, fiberglass handle, safety TPR (Thermo Plastic Rubber) grip handle.
D	SMS60034FG	78601	2	70	7.3 (3.32)	0.350 (0.0099)	34 (86.4)	6 (2.71)	HSH0634F	Splitting maul, forged steel head, fiberglass handle, safety TPR (Thermo Plastic Rubber) grip handle.
-	DF0416FG	78603	4	168	4.4 (2.00)	0.049 (0.0014)	16 (40.6)	4 (1.81)	HBSH016F	Double-faced sledge hammer, fiberglass handle, safety TPR (Thermo Plastic Rubber) grip handle. Designed for wood, concrete, metal and stone.
E	DF0634FG	78604	4	64	8 (3.73)	0.135 (0.0038)	34 (86.4)	6 (2.71)	HSH0634F	
-	DF0834FG	78605	4	72	10 (4.55)	0.160 (0.0045)	34 (86.4)	8 (3.61)	HSH0634F	
-	DF1034FG	78606	2	60	12.6 (5.73)	0.334 (0.0094)	34 (86.4)	10 (4.54)	HSH0634F	
-	DF1234FG	78607	2	40	14 (6.36)	0.370 (0.0105)	34 (86.4)	12 (5.44)	HSH0634F	
-	DF1634FG	78608	2	4	18 (8.18)	0.438 (0.0124)	34 (86.4)	16 (7.22)	HSH0634F	



Hatchets, axes and splitting mauls



KEY	PRODUCT NUMBER	CATALOG NUMBER	PKG.	PALLET PACK	UNIT WEIGHT LB. (KG)	APPROX. NET VOL./UN CU. FT. (CU. M)	HANDLE LENGTH IN. (CM)	HEAD WEIGHT LB. (KG)	REPL. HANDLE EYE US (CAN)	DESCRIPTION
A	HUN12514	81257	4	360	1.60 (0.73)	0.027 (0.0008)	14 (35.6)	1-1/4 (0.57)	B2001405	Hatchet for camping, hunting and fishing, forged steel head, hickory handle.
-	HUN15016	81258	4	440	1.90 (0.86)	0.038 (0.0011)	16 (40.6)	1-1/2 (0.68)	B2011605	
-	HUN15021	81283	4	240	2.12 (0.96)	0.050 (0.0014)	21 (53.3)	1-1/2 (0.68)	B2011605	
B	MDA22528	81284	4	320	3.30 (1.50)	0.092 (0.0026)	28 (71.1)	2-1/4 (1.02)	B1002805	All-purpose axe, Dayton pattern forged steel head, hickory handle, clear varnish finish.
-	MDA30032	80662	2	224	4.19 (1.90)	0.106 (0.0030)	32 (81.3)	3 (1.36)	B1003205	
-	MDA35036	81285	2	224	4.90 (2.22)	0.117 (0.0033)	36 (91.4)	3-1/2 (1.59)	B1003605	
C	SMS30016	81531	2	200	3.39 (1.54)	0.049 (0.0014)	16 (40.6)	3 (1.36)	B4961605	Splitting maul, forged steel head, hickory sledge handle.
D	SMA60036C	80698	2	112	7.30 (3.31)	0.355 (0.0101)	36 (91.4)	6 (2.72)	B1083605	Splitting maul, forged steel head, hickory axe handle. Used for splitting wood in conjunction with woodsplitting wedge by first making a notch with the splitting edge and then driving the wedge with the maul's striking face.
E	SMA80036C	80699	2	112	9.30 (4.22)	0.355 (0.0101)	36 (91.4)	8 (3.63)	B1083605	

* Canadian eye fits older products, see replacement handles for dimensions.



Sledge hammers



KEY	PRODUCT NUMBER	CATALOG NUMBER	PKG.	PALLET PACK	UNIT WEIGHT LB. (KG)	APPROX. NET VOL./UN CU. FT. (CU. M)	HANDLE LENGTH IN. (CM)	HEAD WEIGHT LB. (KG)	REPL. HANDLE EYE US (CAN)	DESCRIPTION
A	DF0424C	81031	4	288	5.00 (2.27)	0.063 (0.0018)	24 (61.0)	4 (1.81)	B3903201SG	Sledge hammer, double face tempered and polished, varnished hickory handle.
B	DF0632C	81032	4	200	7.40 (3.36)	0.131 (0.0037)	32 (81.3)	6 (2.72)	B3903201SG	
C	DF0832C	81033	4	120	9.40 (4.26)	0.157 (0.0044)	32 (81.3)	8 (3.63)	B3903201SG	
D	DF1036C	81034	2	96	11.60 (5.26)	0.338 (0.0096)	36 (91.4)	10 (4.54)	B3903601SG	
-	DF1236C	81035	2	96	13.60 (6.17)	0.372 (0.0105)	36 (91.4)	12 (5.44)	B3903601SG	

* Canadian eye fits older products, see replacement handles for dimensions.



GRIZZLY

Sledge hammers



KEY	PRODUCT NUMBER	CATALOG NUMBER	PKG.	PALLET PACK	UNIT WEIGHT LB. (KG)	APPROX. NET VOL./UN CU. FT. (CU. M)	HANDLE LENGTH IN. (CM)	HEAD WEIGHT LB. (KG)	REPL. HANDLE EYE US (CAN)	DESCRIPTION
A	DF0416	81318	4	144	4.75 (2.16)	0.050 (0.0014)	16 (40.6)	4 (1.81)	(B4061601SG)	Professional quality sledge hammer, double-faced tempered steel head, machine-finished face, varnished premium hickory handle, non-slip safety grip. Used for general sledging operations in striking wood, concrete, metal and stone. Common uses are striking spikes, cold chisels, star drills and hardened nails. Large Canadian eye fitting American eye.
-	DF0424	81319	4	288	5.00 (2.27)	0.063 (0.0018)	24 (61.0)	4 (1.81)	B3002401SG	
B	DF0632	81320	4	200	7.40 (3.36)	0.131 (0.0037)	32 (81.3)	6 (2.72)	B3903201SG (B3003201SG)*	
C	DF0832	81321	4	120	9.40 (4.26)	0.157 (0.0044)	32 (81.3)	8 (3.63)	B3903201SG (B3013201SG)	
D	DF1036	81323	2	96	11.60 (5.26)	0.338 (0.0096)	36 (91.4)	10 (4.54)	B3903601SG (B3013601SG)	
E	DF1236	81324	2	96	13.60 (6.17)	0.372 (0.0105)	36 (91.4)	12 (5.44)	B3903601SG (B3013601SG)	
F	DF1436	81325	2	72	15.60 (7.08)	0.406 (0.0115)	36 (91.4)	14 (6.35)	(B3013601SG)	
G	DF1636	81326	2	72	17.60 (7.98)	0.440 (0.0125)	36 (91.4)	16 (7.26)	(B3013601SG)	
-	DF2036	78617	2	72	17.60 (7.98)	0.440 (0.0125)	36 (91.4)	20 (9.02)	(B3013601SG)	
H	FM1036	81327	2	110	11.60 (5.26)	0.234 (0.0066)	36 (91.4)	10 (4.54)	(B3013601SG)	

* Canadian eye fits older products, see replacement handles for dimensions.

Sledge hammers



Sledge hammers bearing the Magnaflux seal have successfully passed the strict Magnaflux inspection process, guaranteeing that the steel is 100% defect-free. These sledge hammers meet the highest quality standards required by the mining industry. Note: Magnaflux products have premium quality varnished hickory handles.

KEY	PRODUCT NUMBER	CATALOG NUMBER	PKG.	PALLET PACK	UNIT WEIGHT LB. (KG)	APPROX. NET VOL./UN CU. FT. (CU. M)	HANDLE LENGTH IN. (CM)	HEAD WEIGHT LB. (KG)	REPL. HANDLE EYE US (CAN)	DESCRIPTION
A	DF0424X	81514	4	48	5.00 (2.27)	0.063 (0.0018)	24 (61.0)	4 (1.81)	B3002401SG	Magnaflexed double-faced sledge hammer (machined faces), premium varnished hickory handle with safety grip. Certified quality for mining industry.
B	DF0632X	81330	4	48	7.40 (3.36)	0.131 (0.0037)	32 (81.3)	6 (2.72)	B3903201SG (B3003201SG)	
C	DF0832X	81331	4	60	9.40 (4.26)	0.157 (0.0044)	32 (81.3)	8 (3.63)	B3903201SG (B3013201SG)*	
D	DF1036X	81332	2	48	11.60 (5.26)	0.338 (0.0096)	36 (91.4)	10 (4.54)	B3903601SG (B3013601SG)	
E	DF1236X	81515	2	48	13.60 (6.17)	0.372 (0.0105)	36 (91.4)	12 (5.44)	B3903601SG (B3013601SG)	

* Canadian eye fits older products, see replacement handles for dimensions.

Hammers



A MCH25011



B MCH40011



C BSH30016SG



KEY	PRODUCT NUMBER	CATALOG NUMBER	PKG.	PALLET PACK	UNIT WEIGHT LB. (KG)	APPROX. NET VOL./UN CU. FT. (CU. M)	HANDLE LENGTH IN. (CM)	HEAD WEIGHT LB. (KG)	REPL. HANDLE EYE US (CAN)	DESCRIPTION
A	MCH25011	81311	2	360	2.85 (1.29)	0.041 (0.001)	11 (27.9)	2-1/2 (1.13)	B4031001 (B4931005)*	Mason club hammer, varnished premium hickory handle. Used with chisels, punches, star drills and hardened nails. Their design permits heavy blows with limited swing.
B	MCH40011	81312	2	300	4.40 (2.00)	0.049 (0.001)	11 (27.9)	4 (1.81)	B4031001 (B4931005)*	
C	BSH30016SG	81525	2	200	3.50 (1.58)	0.049 (0.001)	16 (40.6)	3 (1.36)	B4961601 (B4061601SG)*	Blacksmith hammer, varnished premium hickory handle with safety grip. The striking face is designed for general blacksmith work in striking unhardened metal. The peens are used for shaping (fullering) and bending unhardened metal.

Fiberglass hammers

A MCH25011FG
MCH40011FG



B BPH0810FG
BPH1212FG
BSH30016FG



C BPH1614FG
BPH2416FG
BPH3216FG
BPH4016FG
BPH4816FG



KEY	PRODUCT NUMBER	CATALOG NUMBER	PKG.	PALLET PACK	UNIT WEIGHT LB. (KG)	APPROX. NET VOL./UN CU. FT. (CU. M)	HANDLE LENGTH IN. (CM)	HEAD WEIGHT LB. (KG)	REPL. HANDLE EYE US (CAN)	DESCRIPTION
A	MCH25011FG	78645	2	252	2.7 (1.23)	0.03 (0.0084)	10 (25.4)	2.5 (1.13)	-	Mason club hammer, fiberglass handle, safety TPR (Thermo Plastic Rubber) grip handle.
-	MCH40011FG	78646	2	150	4.2 (0.0084)	0.04 (0.0011)	10 (25.4)	4 (1.81)	-	
B	BPH0810FG	78610	10	1440	0.76 (0.35)	0.14 (0.0039)	10 (25.4)	8 (3.63)	-	Blacksmith hammer, fiberglass handle, safety TPR (Thermo Plastic Rubber) grip handle.
-	BPH1212FG	78611	10	1080	1.28 (0.58)	0.02 (0.0005)	12 (30.5)	12 (5.44)	-	
-	BSH30016FG	78609	2	168	3.5 (1.57)	0.06 (0.0017)	16 (40.6)	3 (1.36)	HBSH016F	
C	BPH1614FG	78612	10	720	1.42 (0.65)	0.03 (0.0008)	14 (35.6)	16 (7.26)	HBP014F	Machinist ball-pein hammer, fiberglass handle, safety TPR (Thermo Plastic Rubber) grip handle.
-	BPH2416FG	78613	4	288	2.12 (0.96)	0.04 (0.0011)	16 (40.6)	24 (10.89)	-	
-	BPH3216FG	78614	4	576	2.62 (1.19)	0.05 (0.0014)	16 (40.6)	32 (14.51)	-	
-	BPH4016FG	78615	4	512	3.4 (1.55)	0.06 (0.0017)	16 (40.6)	40 (18.14)	-	
-	BPH4816FG	78616	4	448	3.85 (1.75)	0.06 (0.0017)	16 (40.6)	48 (21.77)	-	

Machinist Ball Pein Hammers



KEY	PRODUCT NUMBER	CATALOG NUMBER	PKG.	UNIT WEIGHT LB. (KG)	HEAD WEIGHT OZ (G)	HANDLE LENGTH IN. (CM)	REPL. HANDLE EYE US (CAN)	DESCRIPTION
-	D20405	78080	10	0.50 (0,22)	4 (113,4)	10 (25,4)	B4021005	Machinist ball pein hammer (polished/painted head), varnished hickory handle.
D	D20805	78081	10	0.80 (0,36)	8 (226,8)	12 (30,48)	B4021205	
-	D21205	78082	10	1.00 (0,45)	12 (340,2)	12 (30,48)	B4021205	
E	D21605	78083	10	1.40 (0,64)	16 (453,6)	14 (35,56)	B4021405	
-	D22405	78085	4	2.00 (0,91)	24 (680,4)	16 (40,64)	B4021605	
F	D22405SG	78413	4	2.00 (0,91)	24 (680,4)	16 (40,64)	B4021605	Machinist ball pein hammer (polished/painted head), varnished hickory handle with safety grip.
-	D23205SG	78414	4	2.50 (1,13)	32 (907,2)	16 (40,64)	B4021605	Machinist ball pein hammer (polished/painted head), varnished hickory handle with safety grip.
G	D23205	78086	4	2.50 (1,13)	32 (907,2)	16 (40,64)	B4021605	Machinist ball pein hammer (polished/painted head), varnished hickory handle.
H	D24805	78089	4	3.50 (1,59)	48 (1360,8)	18 (45,72)	B4021805	Machinist ball pein hammer (polished/painted head), varnished hickory handle.
-	D24005	78088	4	3.3 (1,5)	40 (1134)	18 (45,72)	B4021805	
I	D2320NS	78087	4	2.50 (1,13)	32 (907,2)	16 (40,64)	B4021605	Machinist malleable ball pein hammer (non-sparking, brass head), varnished hickory handle.

Mason Club, Blacksmith Hammers

ELGIN®



KEY	PRODUCT NUMBER	CATALOG NUMBER	PKG.	UNIT WEIGHT LB. (KG)	APPROX. NET VOL./UN CU. FT. (CU. M)	HEAD WEIGHT LB. (KG)	HANDLE LENGTH IN. (CM)	REPL. HANDLE EYE US (CAN)	DESCRIPTION
A	D10004	78075	4	3.00 (1,36)	0.041 (0,0012)	2-1/2 (1,13)	10 (25,4)	B4031005	Mason club hammer (machined face), varnished hickory handle. Used with chisels, punches, star drills and hardened nails. Their design permits heavy blows with limited swing, American eye.
-	D10104	78076	4	4.50 (2,04)	0.049 (0,0014)	4 (1,81)	10 (25,4)	B4031005	
B	D10204	78077	4	4.00 (1,81)	0.049 (0,0014)	4 (1,81)	16 (40,64)	B4961605	
C	D30004	78092	4	3.80 (1,72)	0.049 (0,0014)	3 (1,36)	16 (40,64)	B4961605	Blacksmith hammer (machined face), varnished hickory handle. The striking face is designed for general Blacksmith work in striking unhardened metal. The peens are used for shaping (fullering) and bending unhardened metal, American eye.

Sledges

ELGIN®

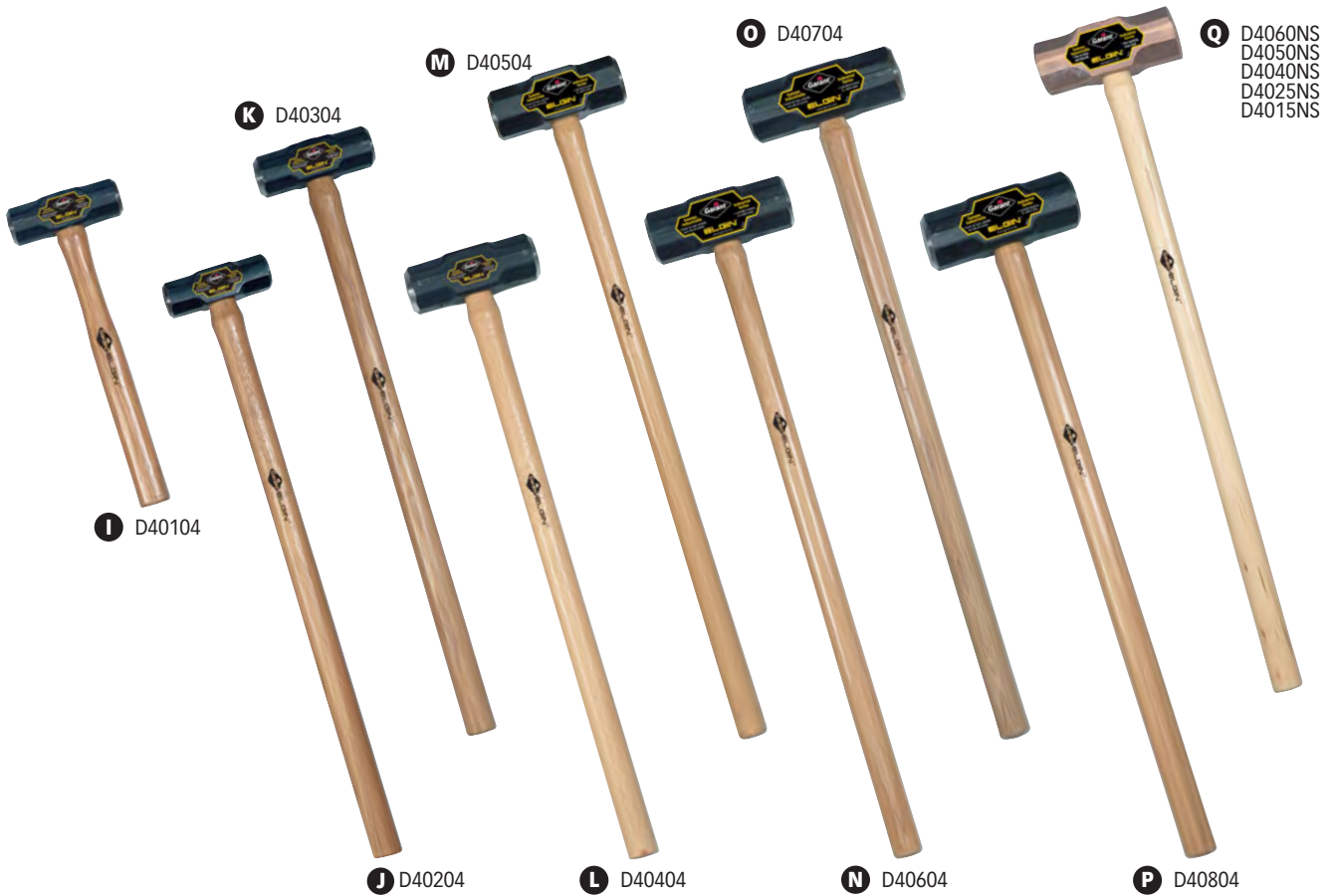

KEY	PRODUCT NUMBER	CATALOG NUMBER	PKG.	PALLET PACK	UNIT WEIGHT LB. (KG)	APPROX. NET VOL./UN CU. FT. (CU. M)	HEAD WEIGHT LB. (KG)	HANDLE LENGTH IN. (CM)	REPL. HANDLE EYE US (CAN)	DESCRIPTION	
I	D40104	78095	4	360	4.50 (2,04)	0.049 (0,0014)	4 (1,81)	16 (40,64)	B4061605	Double face sledge hammer (machined face), forged steel head, varnished hickory handle. Used for general sledging operations in striking wood, concrete, metal and stone. Common uses are striking spikes, cold chisels, star drills and hardened nails.	
J	D40204	78098	4	240	5.00 (2,27)	0.100 (0,0028)	4 (1,81)	32 (81,28)	B3903205		
K	D40304	78102	4	200	7.00 (3,18)	0.131 (0,0037)	6 (2,72)	32 (81,28)	B3903205		
L	D40404	78105	4	120	9.50 (4,31)	0.157 (0,0044)	8 (3,63)	32 (81,28)	B3903205		
M	D40504	78109	2	96	11.00 (4,99)	0.338 (0,0096)	10 (4,54)	36 (91,44)	B3903605		
N	D40604	78113	2	96	13.50 (6,12)	0.372 (0,0105)	12 (5,44)	36 (91,44)	B3903605		
O	D40704	78116	2	72	15.00 (6,80)	0.406 (0,0115)	14 (6,35)	36 (91,44)	(B3013605)		
P	D40804	78118	2	72	17.00 (7,71)	0.440 (0,0125)	16 (7,26)	36 (91,44)	(B3013605)		
-	D4015NS	78096	4	288	4.50 (2,04)	0.040 (2,0)	3 (1,36)	16 (40,64)	-		Double face malleable sledge hammer (forged head with non-sparking, brass head), varnished hickory handle. Used for general sledging operations in striking wood, concrete, metal and stone. Common uses are striking spikes, cold chisels, star drills and hardened nails.
-	D4025NS	78099	4	160	7.20 (3,27)	0.0114 (0,0032)	5 (2,27)	28 (71,12)	B4061605 B3903205		
-	D4040NS	78106	4	120	9.30 (4,22)	0.157 (0,0044)	8 (3,63)	32 (81,28)	B3903605		
-	D4050NS	78110	2	96	11.50 (5,22)	0.338 (0,0096)	10 (4,54)	36 (91,44)	B3903605		
Q	D4060NS	78114	2	96	14.10 (6,40)	0.372 (0,0105)	12 (5,44)	36 (91,44)	B3903605		

Tampers and crowbar



KEY	PRODUCT NUMBER	CATALOG NUMBER	PKG.	PALLET PACK	UNIT WEIGHT LB. (KG)	APPROX. NET VOL./UN CU. FT. (CU. M)	HANDLE LENGTH IN. (CM)	TIP OPENING OZ. (G)	HEAD DIMENSIONS IN. (CM)	SIZED DIMENSIONS IN. (CM)	REPL. HANDLE EYE US (CAN)	DESCRIPTION
A	GT1142	81355	2	42	11.50 (0.0231)	0.815 (0.0231)	42 (106.7)	-	8 x 8 (20.3 x 20.3)	43 (109.2)	C4704209	Forged steel tamper for asphalt and gravel, hardwood handle. Used to pack and level soil.
B	GT1442	81356	2	36	14.50 (6.58)	1.243 (0.0352)	42 (106.7)	-	10 x 10 (25.4 x 25.4)	43 (109.2)	C4704209	Forged steel tamper for asphalt and gravel, hardwood handle. Used to pack and level soil.
C	GDT1769	80472	1	100	17.00 (7.71)	0.900 (0.0255)	-	2-3/8 (6.0)	-	74-3/4 (189.9)	-	High-quality post hole digging-tamper bar, forged steel. Cutter width 2-3/8" (6 cm). Used to dig holes in the ground with the blade end. The tamper head is used to tamp the earth around fence posts and deck supports in the ground.



Pulp hooks and splitting wedges



KEY	PRODUCT NUMBER	CATALOG NUMBER	PKG.	PALLET PACK	UNIT WEIGHT LB. (KG)	APPROX. NET VOL./UN CU. FT. (CU. M)	SIZED DIMENSIONS IN. (CM)	DESCRIPTION
A	PH400	81443	3	192	1.15 (0.52)	0.111 (0.0031)	4 (10.2)	Pulp hook, forged steel, tempered tip, hardwood hand grip.
B	PH500	81445	3	324	1.15 (0.52)	0.111 (0.0031)	5 (12.7)	Pulp hook, forged steel, tempered tip, hardwood hand grip.
C	PH500RT	81447	3	288	1.32 (0.60)	0.111 (0.0031)	5 (12.7)	Pulp hook, forged steel, replaceable tempered tip, hardwood hand grip.
D	82828	82828	1	30	0.06 (0.03)	-	-	2 replacement tempered tips, for pulp hook PH500RT and pickaroons P0628RT, P0636RT and P0643RT.
E	SW55	81364	2	300	5.00 (2.27)	0.015 (0.0004)	-	Steel splitting wedge, forged steel. Used for splitting wood.
F	TSW4	99634	4	600	4.00 (1.81)	0.038 (0.0011)	-	Torpedo™. Innovative splitting wedge. Easy to tap into the log. Wide hitting surface. Maximizes effect of each strike by projecting force in four directions for more efficient splitting.

Wrecking bars and crowbars

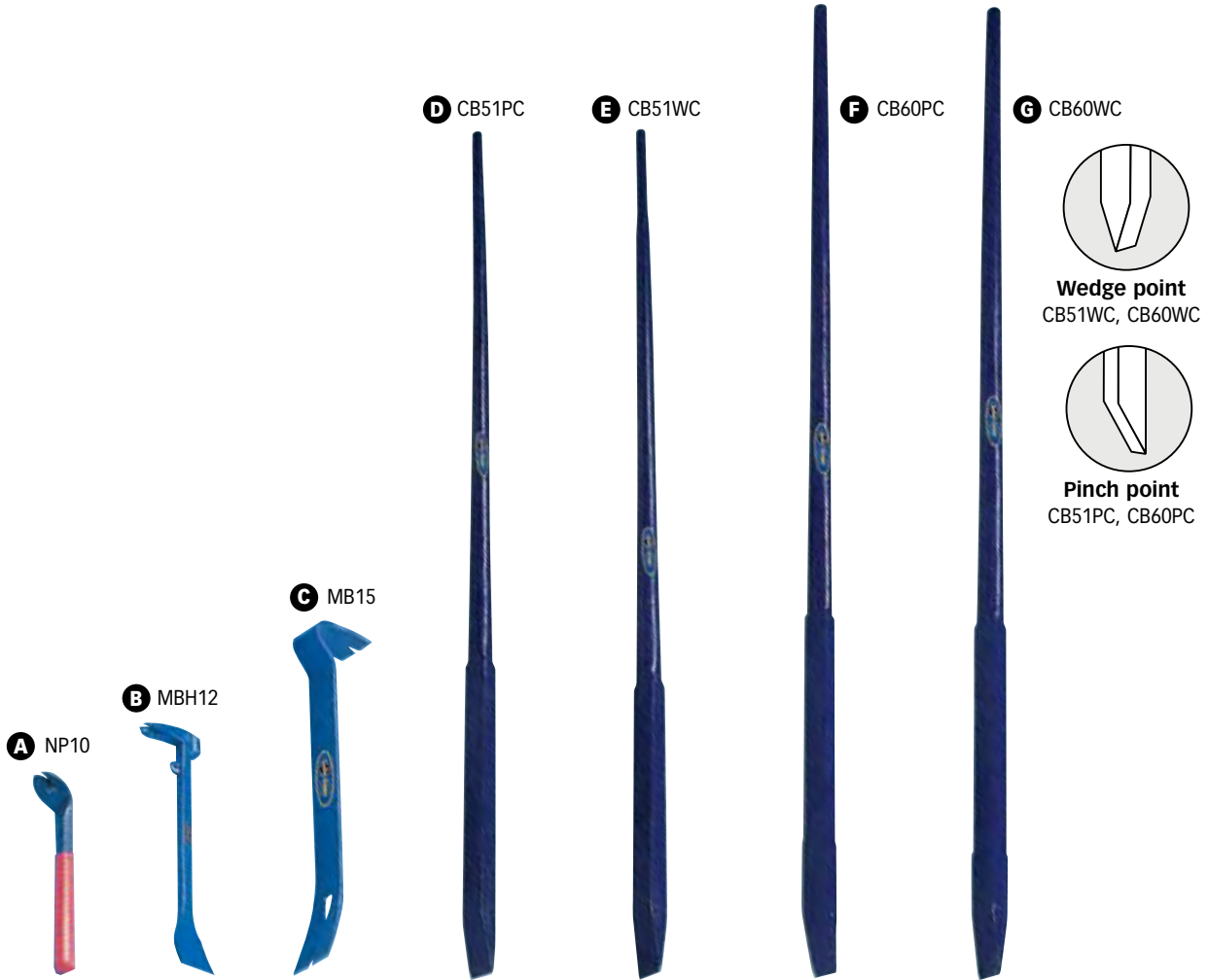

KEY	PRODUCT NUMBER	CATALOG NUMBER	PKG.	PALLET PACK	UNIT WEIGHT LB. (KG)	APPROX. NET VOL./UN CU. FT. (CU. M)	HANDLE LENGTH IN. (CM)	DESCRIPTION
A	NP10	81340	2	3456	1.02 (0.46)	0.010 (0.0003)	10 (25.4)	Small nail puller , forged and tempered steel, hexagonal handle. Ideal for hard-to-reach places. Used for a variety of carpentry and nail pulling applications.
B	MBH12	81473	1	960	0.84 (0.38)	0.038 (0.0011)	11-3/4 (29.9)	Multi-bar, 3-in-1 : pry bar, nail puller, hammer. Forged and tempered steel. Ideal for small carpentry jobs as well as for nailing and prying apart baseboards and trim.
C	MB15	81339	2	1512	1.41 (0.64)	0.020 (0.0006)	15 (38.1)	Flat nail puller , forged and tempered steel. Ideal for hard-to-reach places, does not damage surfaces. Used to open crates and boxes. Remodeling slot nail remover on one end.
D	CB51PC	81037	1	150	12.00 (5.44)	0.034 (0.0010)	51 (129.5)	Crowbar , pinch point, forged and tempered steel. Cutter width 1-1/8" (2.9 cm).
E	CB51WC	81039	1	150	12.00 (5.44)	0.034 (0.0010)	51 (129.5)	Crowbar , wedge point, forged and tempered steel. Cutter width 1-1/8" (2.9 cm).
F	CB60PC	81036	1	120	18.00 (8.16)	0.054 (0.0015)	60 (152.4)	Crowbar , pinch point, forged and tempered steel. Cutter width 1-1/4" (3.2 cm).
G	CB60WC	81038	1	120	18.00 (8.16)	0.054 (0.0015)	60 (152.4)	Crowbar , wedge point, forged and tempered steel. Cutter width 1-1/4" (3.2 cm).

Wrecking bars

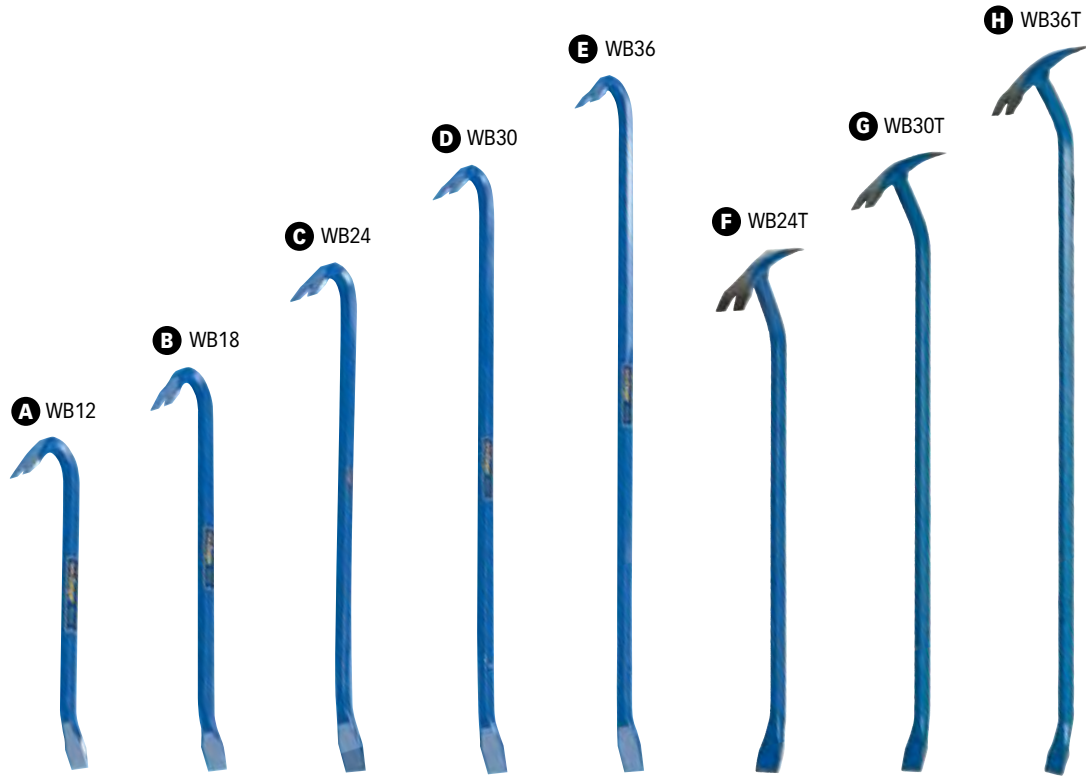

KEY	PRODUCT NUMBER	CATALOG NUMBER	PKG.	PALLET PACK	UNIT WEIGHT LB. (KG)	APPROX. NET VOL./UN CU. FT. (CU. M)	HANDLE LENGTH IN. (CM)	DESCRIPTION
A	WB12	81341	1	12	0.80 (0.36)	0.007 (0.0002)	12 (30.5)	Wrecking bar, forged and tempered steel, baked enamel finish. Used for small construction jobs. Claw on gooseneck end removes nails.
B	WB18	81343	1	12	2.00 (0.91)	0.008 (0.0002)	18 (45.7)	
C	WB24	81345	1	12	3.30 (1.50)	0.014 (0.0004)	24 (61.0)	
D	WB30	81347	1	12	4.10 (1.86)	0.017 (0.0005)	30 (76.2)	
E	WB36	81349	1	12	4.90 (2.22)	0.021 (0.0006)	36 (91.4)	
F	WB24T	78931	1	250	3.80 (1.72)	0.110 (0.0031)	24 (61.0)	"T" wrecking bar, forged steel. Perfect for small construction jobs. Claw on gooseneck to remove nails.
G	WB30T	78932	1	250	4.10 (1.877)	0.163 (0.0046)	30 (76.2)	
H	WB36T	78933	1	250	4.90 (2.222)	0.203 (0.0058)	36 (91.4)	

Picks and brick hammer



KEY	PRODUCT NUMBER	CATALOG NUMBER	PKG.	PALLET PACK	UNIT WEIGHT LB. (KG)	APPROX. NET VOL./UN CU. FT. (CU. M)	HANDLE LENGTH IN. (CM)	REPL. HANDLE EYE US (CAN)	DESCRIPTION
A	HD29	81358	2	150	5.00 (2.27)	0.074 (0.0020)	16-1/4 (41.3)	-	Cutter mattock head , forged and tempered steel. Ideal size for breaking and smoothing hard ground, or for removing rocks and roots.
B	HD19	81357	2	150	5.00 (2.27)	0.074 (0.0020)	18-3/4 (47.6)	-	Pick and mattock head , forged and tempered steel. Used to dig or grub into the earth and for digging in packed earth or clay. Also used to loosen the clay or earth with pick and dig out with mattock end.
C	HD30	81359	2	150	5.00 (2.27)	0.103 (0.0029)	21 (53.3)	-	Clay pick head , forged and tempered steel. Used for digging in clay or packed earth, particularly when long or deep ditches are to be dug.
D	HD40	81360	2	150	6.00 (2.72)	0.103 (0.0029)	22-3/4 (57.8)	-	
E	CAP19	81867	2	96	6.80 (3.08)	1.385 (0.0392)	36 (91.4)	B6053601SG	Pick and mattock head assembled with a 36" hickory handle.
-	CAP40	78419	2	84	7.80 (3.54)	2.917 (0.0826)	36 (91.4)	B6053601SG	Clay pick head assembled with a 36" hickory handle.
F	9923400	99234	2	48	9.375 (4.25)	2.25 (0.063)	36 (91.4)	-	Dig EZ Pick™ , pick and shovel combined, 36" handle, 5.5 lb. head, 4" blade. One extremity can be used as a pick, the other as a shovel to clean holes. Can be used to dig trenches.
G	D22400	78084	4	240	1.90 (0.86)	0.072 (0.0020)	12 (30.5)	-	Brick hammer , polished/painted head, varnished hickory handle.

* Canadian eye fits older products, see replacement handles for dimensions.

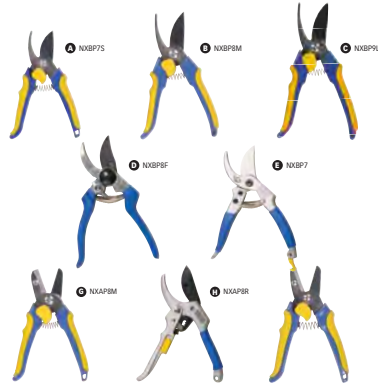

KEY	PRODUCT NUMBER	CATALOG NUMBER	QUALITY	PKG.	MASTER PACK	UNIT WEIGHT LB. (KG)	APPROX. NET VOL./UN CU. FT. (CU.M)	CUT CAPACITY IN. (CM)	APPROX. TOT. LENGTH IN. (CM)	DESCRIPTION
A	NXBP7S	78526	Nature Expert	6	60	0.37 (0.17)	0.0313 (0.0009)	5/8 (1.6)	7 (17.8)	By-pass pruner, small 7" . Heat treated blades, made from top grade, high carbon/ steel/teflon® coated blades for a friction free, smooth, clean cut. Safety latch: locks and unlocks snugly with one hand for your safety. Ergonomically designed, 2-piece molded supergrip handles. Soft non-slip grip is more comfortable and easier to use.
B	NXBP8M	78527	Nature Expert	6	60	0.57 (0.26)	0.0394 (0.0011)	3/4 (1.9)	8 (20.3)	By-pass pruner, medium 8" . Heat treated blades, made from top grade, high carbon/ steel/teflon® coated blades for a friction free, smooth, clean cut. Safety latch: locks and unlocks snugly with one hand for your safety. Ergonomically designed, 2-piece molded supergrip handles. Soft non-slip grip is more comfortable and easier to use.
C	NXBP9L	78528	Nature Expert	6	60	0.63 (0.29)	0.0383 (0.0011)	7/8 (2.2)	9 (22.9)	By-pass pruner, large 9" . Heat treated blades, made from top grade, high carbon/ steel/teflon® coated blades for a friction free, smooth, clean cut. Safety latch: locks and unlocks snugly with one hand for your safety. Ergonomically designed, 2-piece molded supergrip handles. Soft non-slip grip is more comfortable and easier to use.
D	NXBP8F	78529	Nature Expert	6	60	0.59 (0.27)	0.0360 (0.0010)	3/4 (1.9)	8 1/2 (21.6)	By-pass pruner, classic model 8" . Non-rusting aluminum die casting body for long life with non-slip vinyl covered handles for a better grip.
E	NXBP7	78530	Nature Expert	6	60	0.48 (0.22)	0.0285 (0.0008)	5/8 (1.6)	7 (17.8)	By-pass pruner, high precision cut 7" . Heavy-duty aluminum handles with soft non-slip grip more comfortable and easier to use.
F	NXAP7S	78532	Nature Expert	6	60	0.37 (0.17)	0.0323 (0.0009)	5/8 (1.6)	7 (17.8)	Anvil pruner, small 7" . Ergonomically designed 2-piece molded supergrip handles. Soft non-slip grip is more comfortable and easier to use.
G	NXAP8M	78533	Nature Expert	6	60	0.55 (0.25)	0.0402 (0.0011)	3/4 (1.9)	8 (20.3)	Anvil pruner, medium 8" . Ergonomically designed 2-piece molded supergrip handles. Soft non-slip grip is more comfortable and easier to use.
H	NXAP8R	78531	Nature Expert	6	60	0.51 (0.23)	0.0321 (0.0009)	7/8 (2.2)	8 (20.3)	Anvil pruner, large 8" . Quality 4-position ratchet system for maximum cutting performance with less effort. Heat treated blades, made from top grade high carbon steel. Non-stick coated blade for a friction-free, smooth, clean cut. Safety slide latch system for easy opening and locking action.

Lopping Shears, Hand Saw & Pole Tree Trimmers



F NXPT 10



G NXPT12D



KEY	PRODUCT NUMBER	CATALOG NUMBER	QUALITY	PKG.	MASTER PACK	UNIT WEIGHT LB. (KG)	APPROX. NET VOL./UN CU. FT. (CU.M)	CUT CAPACITY IN. (CM)	HANDLE LENGTH IN. (CM)	BLADE DIMENSION IN. (CM)	APPROX. TOT. LENGTH IN. (CM)	DESCRIPTION
A	NXBL29	78539	Nature Expert	6	6	2.24 (1.02)	0.2045 (0.0058)	1 1/2 (3.8)	22 1/2 (57.2)	—	29 (73.7)	By-pass lopping shear, 29" single action . Heat treated blades made with top grade carbon steel. Non-stick blades for a friction-free, smooth, clean cut. Shock-absorbing rubber bumper reduces shock and fatigue while cutting. Lightweight aluminum handles with non-slip comfort grips.
B	NXBL28RT	78540	Nature Expert	6	6	3.63 (1.65)	0.1969 (0.0056)	2 (5.0)	19 1/2-32 (49.5-81.3)	—	27 1/2-40 (69.9-101.6)	By-pass lopping shear, ratchet model 28" . Quality 5-position ratchet system, for less effort and maximum cutting performance. Heat treated cutting blade, made with high carbon steel of top grade Teflon® coating on blades for a friction-free, smooth, clean cut. Serrated by-pass blade to retain branches during cutting action. 6-position telescopic lightweight aluminum handles with comfort non-slip grips.
C	NXAL29	78541	Nature Expert	6	6	2.64 (1.2)	0.1766 (0.0050)	1 1/2 (3.8)	22 1/2 (57.2)	—	28 3/4 (73.0)	Anvil lopping shear, 29" compound action . Heat treated cutting blade, made with high carbon steel of top grade Teflon® coating on blades for a friction-free, smooth, clean cut. Shock-absorbing rubber bumper reduces shock and fatigue while cutting. Lightweight aluminum handles with comfort non-slip grips.
D	NXAL30D	78542	Nature Expert	6	6	2.81 (2.72)	0.1431 (0.0041)	1 1/2 (3.8)	22 (55.9)	—	29 3/4 (75.6)	Anvil lopping shear, 30" double action shock-absorbing rubber bumper . Heat treated blades made with top grade carbon steel. Non-stick blades for a friction-free, smooth, clean cut. Shock-absorbing rubber bumper reduces shock and fatigue while cutting. Lightweight aluminum handles with non-slip comfort grips.
E	NXFS6	78543	Nature Expert	6	72	0.49 (0.22)	0.0040 (0.0001)	—	8 (20.32)	6 1/4 (15.9)	13 3/4 (34.9)	Hand saw, folding arm . Ideal for pruning, camping around the house. 6" deep-cutting teeth blade for fast, accurate cuts. Precision teeth ensure chip-free cut. Stays sharp for years of use. Ergonomically designed, cushioned handle with soft non-slip grip. More comfortable and easier to use.
F	NXPT10	78546	Nature Expert	4	—	4.10 (1.86)	0.7084 (0.0201)	1 1/4 (3.2)	60 (152.4)	12 (30.5)	79 (200.7)	Tree trimmer pole, 10' . Telescopic handle in two, 10-foot (3 m) long fiberglass sections. Ideal for reaching the highest branches. 14-in. saw blade for cutting the biggest branches. Double pulley head with by-pass blades made from high carbon steel. Teflon® coating on blades for a friction-free, smooth, clean cut. Cutting capacity of the by-pass blades: 1 1/4". For branches more than 1 1/4": use saw blade.
G	NXPT12D	78545	Nature Expert	4	—	4.55 (2.07)	0.8161 (0.0231)	1 1/4 (3.2)	72 (182.9)	14 1/4 (36.8)	91 (231.1)	Tree trimmer pole, 12' double pulley . Telescopic handle in two, 12-foot (3.7 m) long fiberglass sections. Ideal for reaching the highest branches. 14-in. blade saw for cutting the biggest branches. Double pulley head with by-pass blades made from high carbon steel. Teflon® coating on blades for a friction-free, smooth, clean cut. Cutting capacity of the by-pass blades: 1 1/4". For branches more than 1 1/4": use saw blade.



Grass and Hedge Shears & Bow Saws

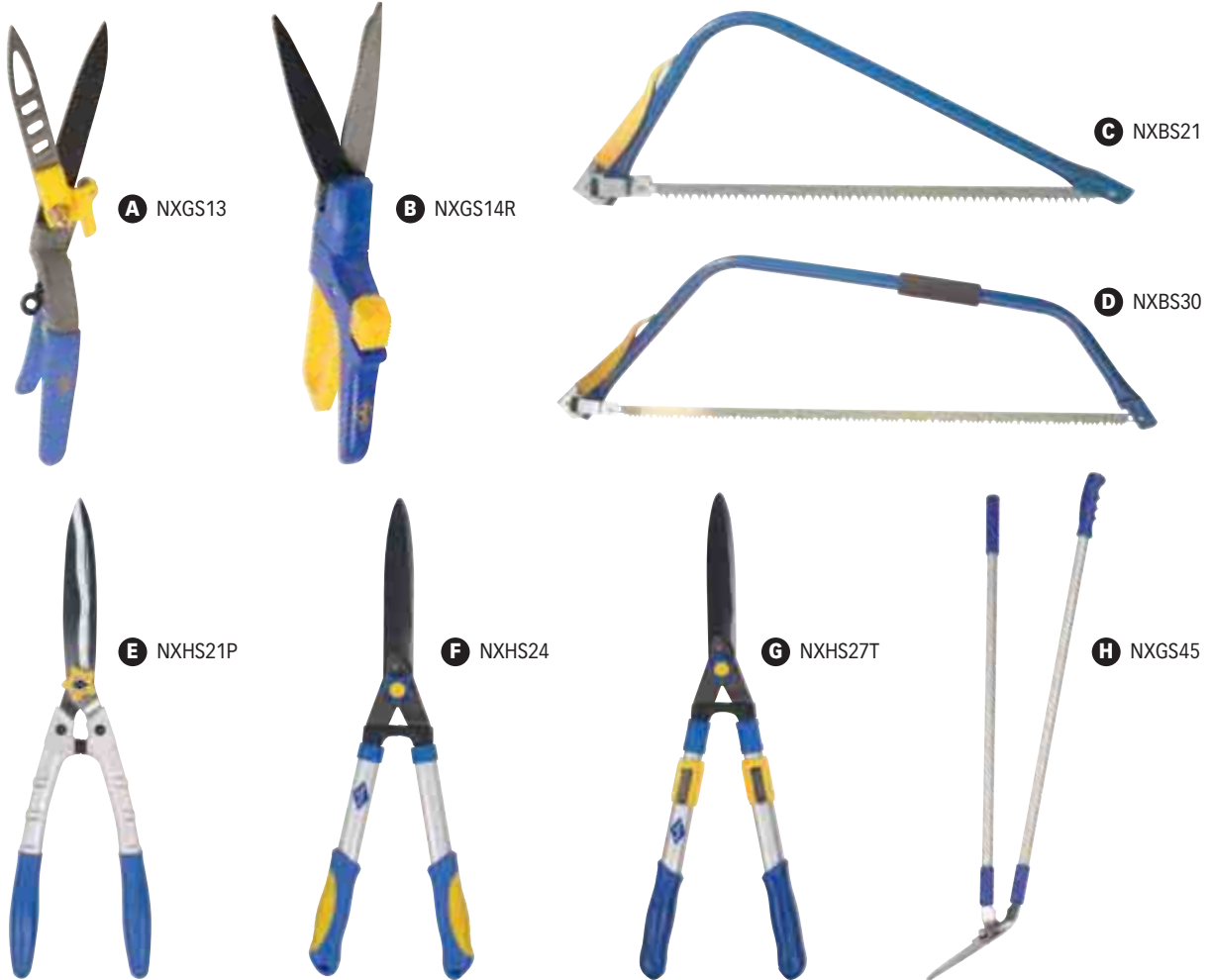

KEY	PRODUCT NUMBER	CATALOG NUMBER	QUALITY	PKG.	UNIT	MASTER WEIGHT	UNIT	APPROX.	HANDLE	BLADE/HEAD	APPROX.	DESCRIPTION
				PACK	PKG.	LB. (KG)	NET VOL./UN	LENGTH	DIMENSIONS	TOT. LENGTH	IN. (CM)	
							CU. FT. (CU.M)	IN. (CM)	IN. (CM)	IN. (CM)		
A	NXGS13	78534	Nature Expert	6	24	1.09 (0.50)	0.0339 (0.0010)	7 (17.78)	4 1/2 (11.43)	13 (33.02)		Grass shear, 13". Non-slip handles. Heat treated, high carbon steel blades for longer life. TFE® non-stick coating. Cushioned grips for greater comfort.
B	NXGS14R	78535	Nature Expert	6	48	0.81 (0.37)	0.0649 (0.0018)	9 (22.86)	5 1/4 (13.34)	14 (35.56)		Grass shear, 14". 9-position, 180 degree rotating head for horizontal, vertical and diagonal cutting. Heat treated, high carbon steel blades. Cutting blade with non-stick coating. Blade cutting guide under the blade ensures a consistently even cut. Oversized safety latch.
C	NXBS21	78821	Nature Expert	5	50	0.952 (0.42)	0.155 (0.0044)	—	21 (53.34)	24.5 (62.2)		21" bow saw. Cam-lever blade tension system keeps blade at the right tension for quick, accurate cutting.
D	NXBS30	78822	Nature Expert	5	30	1.410 (0.64)	0.23 (0.0065)	—	30 (76.20)	33.5 (85.1)		30" bow saw. Plated steel tubular frame for a durable, heavy-duty saw. Blade cover included.
E	NXHS21P	78536	Nature Expert	2	6	2.23 (1.01)	0.0981 (0.0028)	12 1/2 (31.75)	7 3/4 (19.69)	22 1/4 (56.52)		Hedge shear, high-precision cut 21". Heat treated blades, made from top grade high carbon steel. Wavy blades hold branches while cutting. Tension knob can be adjusted to user's strength and fatigue level for added comfort during extended use. Ergonomically designed, lightweight aluminum handles with non-slip comfort grips.
F	NXHS24	78537	Nature Expert	2	6	2.47 (1.12)	0.1502 (0.0043)	12 (30.5)	8 1/2 (21.59)	24 1/2 (62.23)		Hedge shear, classic model 24". Heat treated blades, made from top grade high carbon steel. Non-stick coated blades for a friction-free, smooth, clean cut. Tension knob can be adjusted to user's strength and fatigue level for added comfort during extended use. Lightweight aluminum handles with non-slip comfort grips.
G	NXHS27T	78538	Nature Expert	2	6	3.21 (1.46)	0.1803 (0.0051)	14 1/2-22 (36.8-55.9)	8 1/2 (21.59)	27-34 1/2 (68.8-87.6)		Hedge shear, 27"—telescopic handles. Heat treated wavy blades, made from top grade high carbon steel teflon-coated blades for a friction-free, smooth, clean cut. Tension knob can be adjusted to user's strength and fatigue level for added comfort during extended use. Lightweight aluminum, 5-position telescopic handles.
H	NXGS45	78940	Nature Expert	6	72	5 (2.27)	0.741 (0.0210)	35.17 (89.33)	7.625 (19.37)	45 (114.3)		Steel grass shear, 45". Perfect for pruning grass along flowerbeds and rock gardens. Long 37" handles that reduce the user's effort by allowing him to cut grass without bending. Made from durable tubular steel with sturdy steel blades.



KEY	PRODUCT NUMBER	CATALOG NUMBER	QUALITY	PKG.	MASTER PACK	UNIT WEIGHT LB. (KG)	APPROX. NET VOL./UN CU. FT. (CU.M)	CUT CAPACITY IN. (CM)	APPROX. TOT. LENGTH IN. (CM)	DESCRIPTION
A	NXBP7S	78526	Nature Expert	6	60	0.37 (0.17)	0.0313 (0.0009)	5/8 (1.6)	7 (17.8)	By-pass pruner, small 7" . Heat treated blades, made from top grade, high carbon/ steel/teflon® coated blades for a friction free, smooth, clean cut. Safety latch: locks and unlocks snugly with one hand for your safety. Ergonomically designed, 2-piece molded supergrip handles. Soft non-slip grip is more comfortable and easier to use.
B	NXBP8M	78527	Nature Expert	6	60	0.57 (0.26)	0.0394 (0.0011)	3/4 (1.9)	8 (20.3)	By-pass pruner, medium 8" . Heat treated blades, made from top grade, high carbon/ steel/teflon® coated blades for a friction free, smooth, clean cut. Safety latch: locks and unlocks snugly with one hand for your safety. Ergonomically designed, 2-piece molded supergrip handles. Soft non-slip grip is more comfortable and easier to use.
C	NXBP9L	78528	Nature Expert	6	60	0.63 (0.29)	0.0383 (0.0011)	7/8 (2.2)	9 (22.9)	By-pass pruner, large 9" . Heat treated blades, made from top grade, high carbon/ steel/teflon® coated blades for a friction free, smooth, clean cut. Safety latch: locks and unlocks snugly with one hand for your safety. Ergonomically designed, 2-piece molded supergrip handles. Soft non-slip grip is more comfortable and easier to use.
D	NXBP8F	78529	Nature Expert	6	60	0.59 (0.27)	0.0360 (0.0010)	3/4 (1.9)	8 1/2 (21.6)	By-pass pruner, classic model 8" . Non-rusting aluminum die casting body for long life with non-slip vinyl covered handles for a better grip.
E	NXBP7	78530	Nature Expert	6	60	0.48 (0.22)	0.0285 (0.0008)	5/8 (1.6)	7 (17.8)	By-pass pruner, high precision cut 7" . Heavy-duty aluminum handles with soft non-slip grip more comfortable and easier to use.
F	NXAP7S	78532	Nature Expert	6	60	0.37 (0.17)	0.0323 (0.0009)	5/8 (1.6)	7 (17.8)	Anvil pruner, small 7" . Ergonomically designed 2-piece molded supergrip handles. Soft non-slip grip is more comfortable and easier to use.
G	NXAP8M	78533	Nature Expert	6	60	0.55 (0.25)	0.0402 (0.0011)	3/4 (1.9)	8 (20.3)	Anvil pruner, medium 8" . Ergonomically designed 2-piece molded supergrip handles. Soft non-slip grip is more comfortable and easier to use.
H	NXAP8R	78531	Nature Expert	6	60	0.51 (0.23)	0.0321 (0.0009)	7/8 (2.2)	8 (20.3)	Anvil pruner, large 8" . Quality 4-position ratchet system for maximum cutting performance with less effort. Heat treated blades, made from top grade high carbon steel. Non-stick coated blade for a friction-free, smooth, clean cut. Safety slide latch system for easy opening and locking action.

Lopping Shears, Hand Saw & Pole Tree Trimmers



F NXPT 10



G NXPT12D



KEY	PRODUCT NUMBER	CATALOG NUMBER	QUALITY	PKG.	MASTER PACK	UNIT WEIGHT LB. (KG)	APPROX. NET VOL./UN CU. FT. (CU.M)	CUT CAPACITY IN. (CM)	HANDLE LENGTH IN. (CM)	BLADE DIMENSION IN. (CM)	APPROX. TOT. LENGTH IN. (CM)	DESCRIPTION
A	NXBL29	78539	Nature Expert	6	6	2.24 (1.02)	0.2045 (0.0058)	1 1/2 (3.8)	22 1/2 (57.2)	—	29 (73.7)	By-pass lopping shear, 29" single action . Heat treated blades made with top grade carbon steel. Non-stick blades for a friction-free, smooth, clean cut. Shock-absorbing rubber bumper reduces shock and fatigue while cutting. Lightweight aluminum handles with non-slip comfort grips.
B	NXBL28RT	78540	Nature Expert	6	6	3.63 (1.65)	0.1969 (0.0056)	2 (5.0)	19 1/2-32 (49.5-81.3)	—	27 1/2-40 (69.9-101.6)	By-pass lopping shear, ratchet model 28" . Quality 5-position ratchet system, for less effort and maximum cutting performance. Heat treated cutting blade, made with high carbon steel of top grade Teflon® coating on blades for a friction-free, smooth, clean cut. Serrated by-pass blade to retain branches during cutting action. 6-position telescopic lightweight aluminum handles with comfort non-slip grips.
C	NXAL29	78541	Nature Expert	6	6	2.64 (1.2)	0.1766 (0.0050)	1 1/2 (3.8)	22 1/2 (57.2)	—	28 3/4 (73.0)	Anvil lopping shear, 29" compound action . Heat treated cutting blade, made with high carbon steel of top grade Teflon® coating on blades for a friction-free, smooth, clean cut. Shock-absorbing rubber bumper reduces shock and fatigue while cutting. Lightweight aluminum handles with comfort non-slip grips.
D	NXAL30D	78542	Nature Expert	6	6	2.81 (2.72)	0.1431 (0.0041)	1 1/2 (3.8)	22 (55.9)	—	29 3/4 (75.6)	Anvil lopping shear, 30" double action shock-absorbing rubber bumper . Heat treated blades made with top grade carbon steel. Non-stick blades for a friction-free, smooth, clean cut. Shock-absorbing rubber bumper reduces shock and fatigue while cutting. Lightweight aluminum handles with non-slip comfort grips.
E	NXFS6	78543	Nature Expert	6	72	0.49 (0.22)	0.0040 (0.0001)	—	8 (20.32)	6 1/4 (15.9)	13 3/4 (34.9)	Hand saw, folding arm . Ideal for pruning, camping around the house. 6" deep-cutting teeth blade for fast, accurate cuts. Precision teeth ensure dog-free cut. Stays sharp for years of use. Ergonomically designed, cushioned handle with soft non-slip grip. More comfortable and easier to use.
F	NXPT10	78546	Nature Expert	4	—	4.10 (1.86)	0.7084 (0.0201)	1 1/4 (3.2)	60 (152.4)	12 (30.5)	79 (200.7)	Tree trimmer pole, 10' . Telescopic handle in two, 10-foot (3 m) long fiberglass sections. Ideal for reaching the highest branches. 14-in. saw blade for cutting the biggest branches. Double pulley head with by-pass blades made from high carbon steel. Teflon® coating on blades for a friction-free, smooth, clean cut. Cutting capacity of the by-pass blades: 1 1/4". For branches more than 1 1/4": use saw blade.
G	NXPT12D	78545	Nature Expert	4	—	4.55 (2.07)	0.8161 (0.0231)	1 1/4 (3.2)	72 (182.9)	14 1/4 (36.8)	91 (231.1)	Tree trimmer pole, 12' double pulley . Telescopic handle in two, 12-foot (3.7 m) long fiberglass sections. Ideal for reaching the highest branches. 14-in. blade saw for cutting the biggest branches. Double pulley head with by-pass blades made from high carbon steel. Teflon® coating on blades for a friction-free, smooth, clean cut. Cutting capacity of the by-pass blades: 1 1/4". For branches more than 1 1/4": use saw blade.

SOO LINE

Product No.	Socket Diameter	Length (Feet)
120 A	2-3/8"	3
120	2-3/8"	3-1/2
121	2-3/8"	4
122	2-3/8"	4-1/2
123	2-1/2"	5
130 C	2-1/2"	3
130 B	2-1/2"	3-1/2
130 A	2-1/2"	4
130	2-1/2"	4-1/2
131	2-1/2"	5

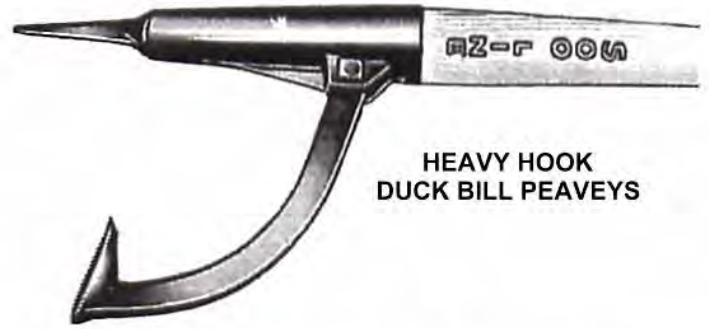

**HEAVY HOOK
DUCK BILL PEAVEYS**

Product No.	Socket Diameter	Length (Feet)
158	2-3/8"	2-1/2
159 A	2-3/8"	3
159 B	2-3/8"	3-1/2
159	2-3/8"	4
160	2-1/2"	4-1/2

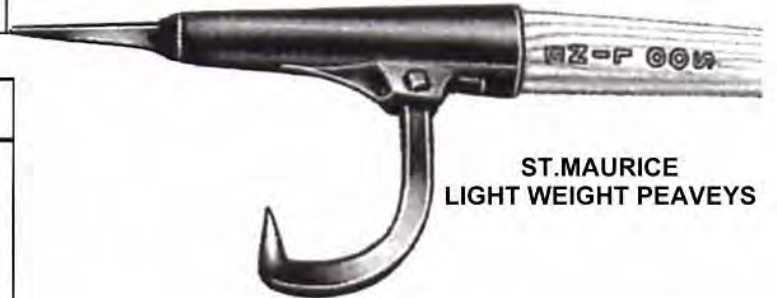

**ST. MAURICE
LIGHT WEIGHT PEAVEYS**

Product No.	Socket Diameter	Length (Feet)
178 A	2-3/8"	2-1/2
178	2-3/8"	3
179 A	2-3/8"	3-1/2
179	2-3/8"	4
180	2-3/8"	4-1/2
181	2-3/8"	5



CANT HOOK

TIMBER CARRIER

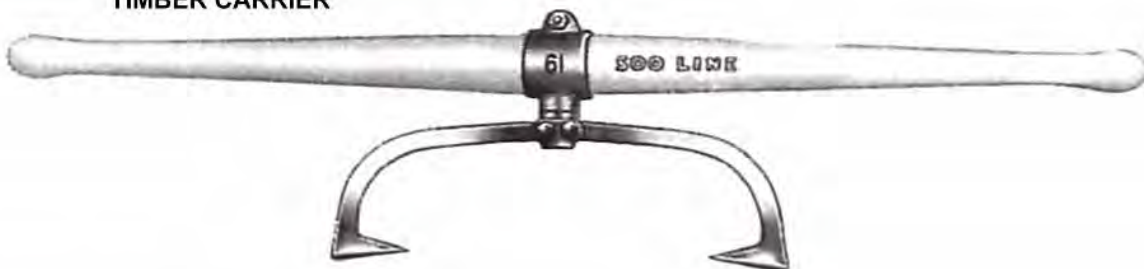

ELECTRIC SPUD NO. E 90

SCALING BARS STEEL OR ALUMINUM

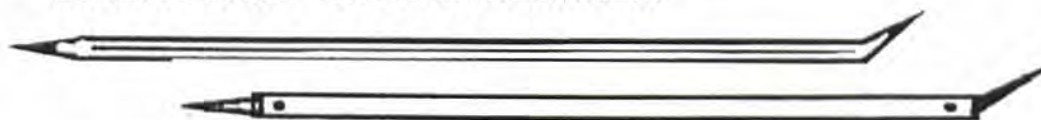



Model 1038 "Flat Free" Contractor Wheel Kit

- "Flat Free" tire is made of polyurethane
- No inner tube, puncture proof
- Great for construction sites, rugged terrain and heavy loads
- "Flat Free" wheel kits available to modify 1035 Contractor



Parts Kits

Convenient Parts Kits are readily available to keep your wheelbarrow running strong.



Model 10352W Dual Wheel

- Dual wheels for added stability
- Kits available to modify 1035 Contractor



Model 5035 Brick Cart

Ideal for bricks, drainage tile, any heavy bulk items; hardwood slats form a sturdy platform attached to handles; heavy-duty wheel and frame with thick channel steel undercarriage.